

TL70 Modular Tower Light



Instruction Manual



Banner's TL70 Tower Light is a 70 mm, modular LED indicator with extremely bright and uniform light. The modularity gives the user flexibility to customize tower lights as needed and change positions in the field. The TL70 is also available preassembled for easy installation.

- Light segments have user-selectable solid ON or flashing
- Up to six colors, or five colors plus audible, in one device
- Rugged, water-resistant IP65 housing with UV-stabilized material
- Bright, uniform indicator segments appear gray when off to eliminate false indication from ambient light
- Several connection options to choose from including M12 quick disconnect, cabled, and terminal-wired

Models

TL70 Base

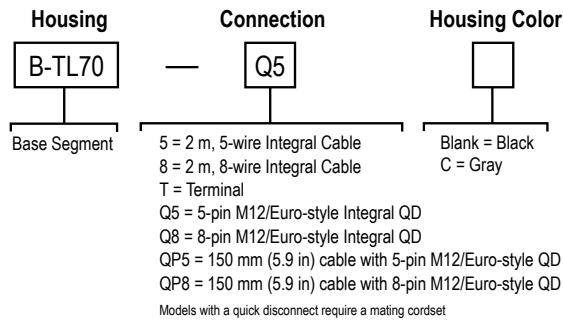

TL70 Segments

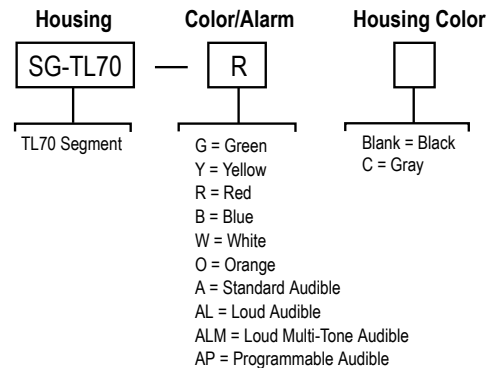

Select the 5-pin base for tower light configurations of up to 4 modules. Select the 8-pin base for tower light configurations of up to 6 modules.

- Example base model number: B-TL70-Q5
- Example light segment model number: SG-TL70-G
- Example audible segment model number: SG-TL70-A

TL70 Pre-Assembled Models

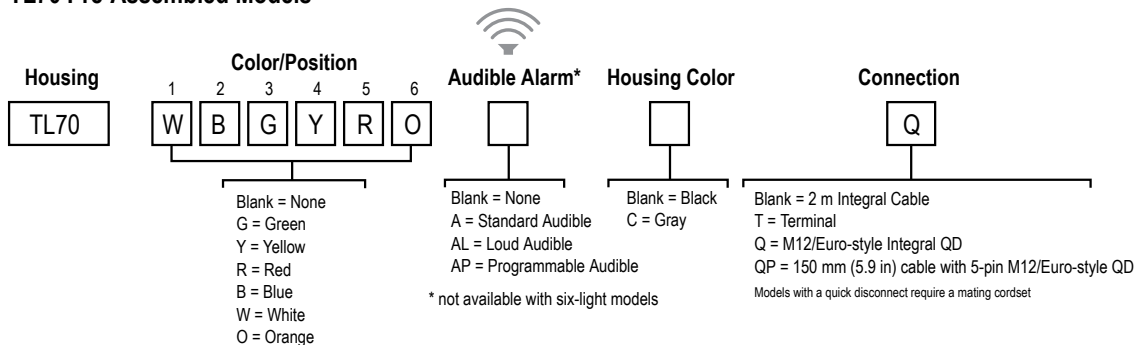

- Example pre-assembled model number: TL70GYRAQ.



Configuring the Modules



Turn on the appropriate DIP switch to set the order of the components, counting up from the tower light's base.

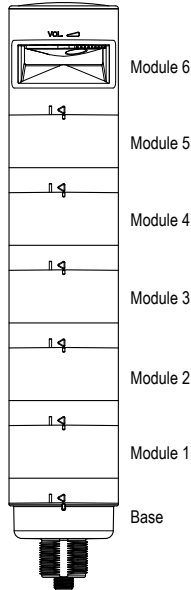

Assembly Options		DIP Switches							
		1	2	3	4	5	6	7	8
Light and Standard Audible Components	Module 1	ON							
	Module 2		ON						
	Module 3			ON					
	Module 4				ON				
	Module 5					ON			
	Module 6						ON		
Light Module Flash Rate	3 Hz							ON	OFF
	1.5 Hz							ON	ON
	Solid On*							OFF	OFF
Standard Audible Module Settings	Pulse 1.5 Hz							ON	OFF
	Chirp Alarm							ON	ON
	Siren Alarm							OFF	ON
	Continuous Alarm*							OFF	OFF

Assembly Options		DIP Switches									
		1	2	3	4	5	6	7	8	9	10
Loud Audible Module Settings	Pulse 1.5 Hz							ON	OFF		
	Chirp Alarm							ON	ON		
	Siren Alarm							OFF	ON		
	Continuous Alarm*							OFF	OFF		
	Low Intensity*									OFF	OFF
	Med. Intensity									ON	OFF
	Med./Loud Intensity									OFF	ON
	Loud Intensity									ON	ON

* Factory default setting

Programming the Audible Tower Module

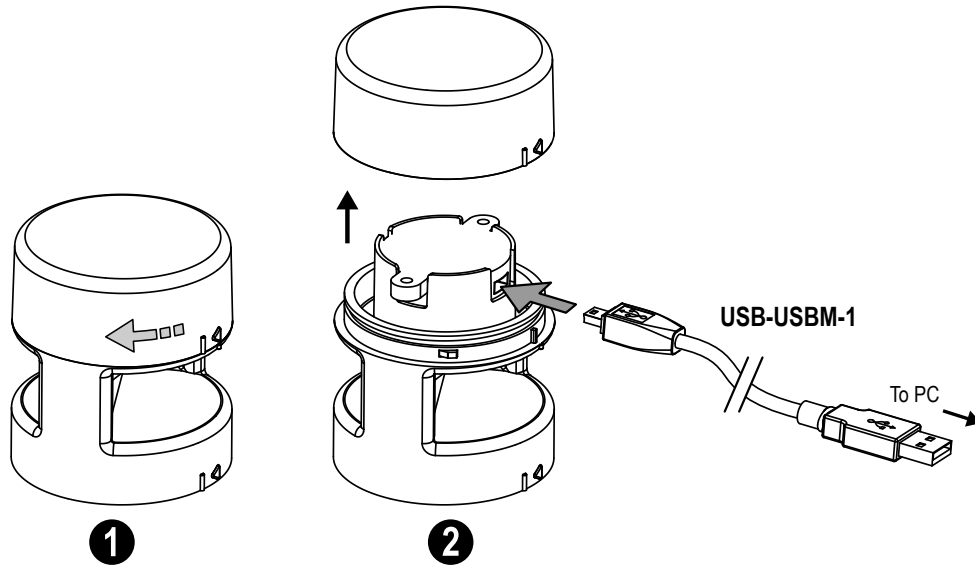

Loading Files into the SG-TL70-AP

The SG-TL7-AP has 4MB of on-board flash memory and can playback any WAV or MP3 audio file that is 4MB or smaller. If the file is too large, a program such as Audacity can be used to compress or shorten the file to decrease the size.

Multiple files can be loaded onto the SG-TL70-AP. Files playback according to the file name in alpha-numeric order.



Note: Add a number to the beginning of the file name to create the order in which the files run. Files play consecutively without any pause.

To program the module:

1. Remove the module top cover by rotating counterclockwise.
2. Connect the programming cable (USB-USBM-1) from the PC's USB connection to the USB mini-connection of the audible module.

The SG-TL70-AP is recognized by the PC as a USB flash drive. The default drivers for a USB drive are assigned to the device, as well as a unique disk drive letter assignment (such as D:).

3. Drag-and-drop the audio files that are saved on the PC to the USB drive location.
4. Assign numbers to each file to designate their playback order, otherwise files playback in alpha-numeric order.
5. Remove the cable from the audio module.
6. Re-install the top cover by aligning the protruding alignment marks and turning clockwise.
7. The audible module is now ready for use with a compatible TL70 DC Base or Universal Voltage AC Base.

When the selected Input Channel is activated, the audible module begins playing the files in sequential order.

Assembling the Modules

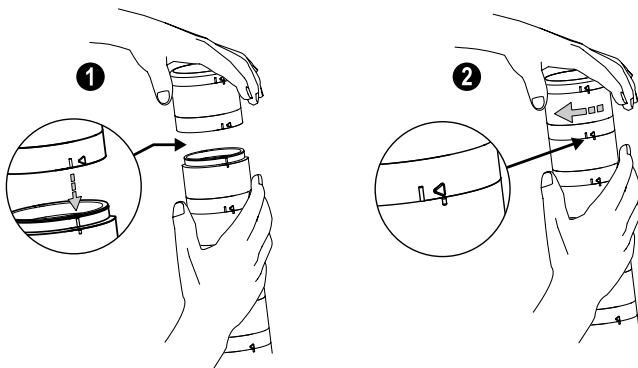

To assemble the modules:

1. Align the notches on each module and press together.
2. Rotate the top module clockwise to lock into place (notches shown in the locked position).

Wiring Diagrams

PNP Input

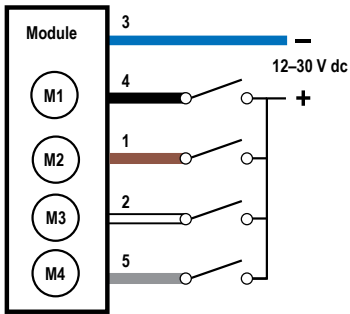

NPN Input

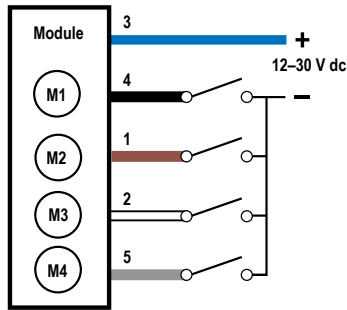

Euro-style Male Pinouts

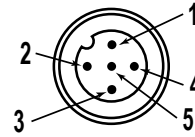

Key

- 1 = brown
- 2 = white
- 3 = blue
- 4 = black
- 5 = gray
- M1 = Module 1
- M2 = Module 2
- M3 = Module 3
- M4 = Module 4

PNP Input

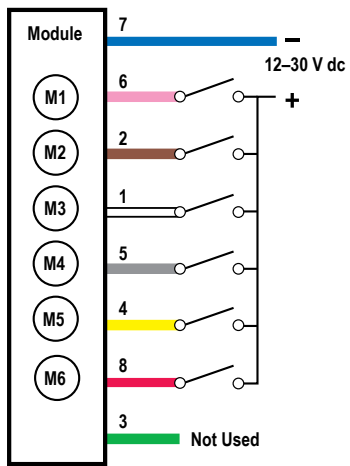

NPN Input

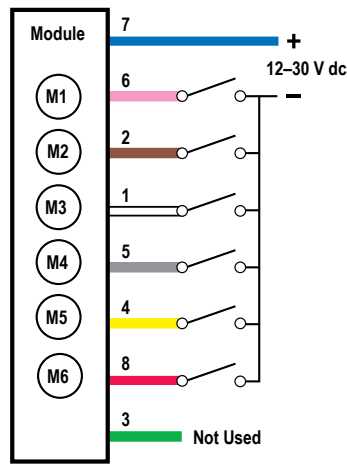

Euro-style Male Pinouts

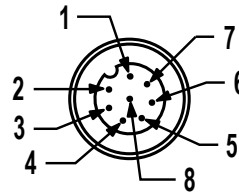

Key

- 1 = white
- 2 = brown
- 3 = green
- 4 = yellow
- 5 = gray
- 6 = pink
- 7 = blue
- 8 = red
- M1 = Module 1
- M2 = Module 2
- M3 = Module 3
- M4 = Module 4
- M5 = Module 5
- M6 = Module 6



Note: Models SG-TL70-ALM and SG-TL70-ALMC are not compatible with NPN input wiring.

Wiring Terminal Block

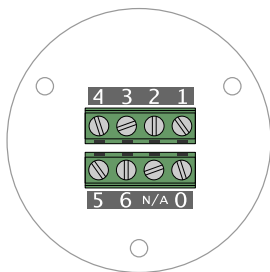

Terminal Block Key

- 0 = dc common
- 1 = Module 1
- 2 = Module 2
- 3 = Module 3
- 4 = Module 4
- 5 = Module 5
- 6 = Module 6

Specifications

Supply Voltage and Current

12 V DC to 30 V DC

Indicator Color or Audible Model	Maximum Current (mA)		
	at 12 V DC	at 24 V DC	at 30 V DC
Blue, Green, White	420	200	150
Red, Yellow, Orange	285	145	120
Standard Audible	30	30	30
Loud Audible (Intensity 1)	30	28	25
Loud Audible (Intensity 2)	50	45	40
Loud Audible (Intensity 3)	165	90	75
Loud Audible (Intensity 4)	350	160	120
Programmable Audible	290	140	125

Supply Protection Circuitry

Protected against transient voltages

Indicators

1 to 6 colors depending on model (Green, Red, Yellow, Blue, White, and Orange)

LEDs are independently selected

Flash Rates: 1.5 Hz ±10% and 3 Hz ±10%

Indicator Response Time

Off Response: 150 μs (maximum) at 12 V DC to 30 V DC

On Response: 180 ms (maximum) at 12 V DC; 50 ms (maximum) at 30 V DC

Indicator Characteristics

Color	Dominant Wavelength (nm) or Color Temperature (CCT)	Color Coordinates ¹		Lumen Output (Typical at 25 °C)
		x	y	
Green	525 nm	–	–	92
Red	625 nm	–	–	40
Yellow	590 nm	–	–	22
Blue	470 nm	–	–	32
White	5000 K	–	–	125
Orange	–	0.66	0.33	33

Connections

5-pin M12 quick disconnect connector, 8-pin M12 quick disconnect connector, 150 mm (5.9 in) PVC cable with an M12 quick disconnect connector, terminal block, or 2 m (6.5 ft) unterminated cable, depending on model

Terminal Block Models

14 to 28 AWG wire

Operating Conditions

–40 °C to +50 °C (–40 °F to +122 °F)

95% at +50 °C maximum relative humidity (non-condensing)

Environmental Rating

IEC IP65

Certifications



Audible Alarm

Standard Audible: 2.6 kHz ± 250 Hz oscillation frequency; maximum intensity (typical) 92 dB at 1 m (3.3 ft)

Loud Audible: 2.6 kHz ± 250 Hz oscillation frequency; maximum intensity (typical) at 1 m (3.3 ft) (see table)

DIP Switches		Max Intensity (Loud Audible)
9	10	
ON	ON	Intensity 4: 101 dB
OFF	ON	Intensity 3: 99 dB
ON	OFF	Intensity 2: 92 dB
OFF	OFF	Intensity 1: 85 dB

Audible Adjustment

Standard Audible: Rotate the cover until the desired volume is reached

Loud Audible Alarm: Select the desired volume using DIP switches 9 and 10

Typical Reduction in Sound Intensity with Audible Adjustment (maximum to minimum):

- **Standard Audible:** 8 dB
- **Loud Audible:** 16 dB

Construction

Bases, Segments, Covers: polycarbonate

Vibration and Mechanical Shock

Vibration: 10 Hz to 55 Hz, 0.5 mm peak-to-peak amplitude per IEC 60068-2-6

Shock: 15G 11 ms duration, half sine wave per IEC 60068-2-27

Required Overcurrent Protection



WARNING: Electrical connections must be made by qualified personnel in accordance with local and national electrical codes and regulations.

Overcurrent protection is required to be provided by end product application per the supplied table.

Overcurrent protection may be provided with external fusing or via Current Limiting, Class 2 Power Supply.

Supply wiring leads < 24 AWG shall not be spliced.

For additional product support, go to www.bannerengineering.com.

Supply Wiring (AWG)	Required Overcurrent Protection (Amps)
20	5.0
22	3.0
24	2.0
26	1.0
28	0.8
30	0.5

¹ Refer to CIE 1931 chromaticity diagram or color chart, to show equivalent color with indicated color coordinates.

Dimensions

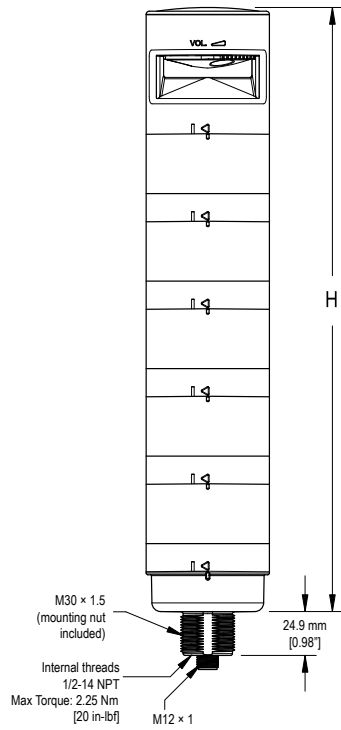

Model	Height (H)
1 light module	87.6 mm (3.45 in)
1 light module, 1 audible module	144.3 mm (5.68 in)
2 light modules	137.3 mm (5.41 in)
2 light modules, 1 audible module	194 mm (7.64 in)
3 light modules	187 mm (7.36 in)
3 light modules, 1 audible module	243.7 mm (9.59 in)
4 light modules	236.7 mm (9.32 in)
4 light modules, 1 audible module	293.4 mm (11.55 in)
5 light modules	286.4 mm (11.28 in)
5 light modules, 1 audible module	343.1 mm (13.5 in)

Accessories

Cordsets

5-Pin Threaded M12 Cordsets—Single Ended				
Model	Length	Style	Dimensions	Pinout (Female)
MQDC1-501.5	0.5 m (1.5 ft)	Straight		<p>1 = Brown 2 = White 3 = Blue 4 = Black 5 = Gray</p>
MQDC1-506	2 m (6.5 ft)			
MQDC1-515	5 m (16.4 ft)			
MQDC1-530	9 m (29.5 ft)	Right-Angle		
MQDC1-506RA	2 m (6.5 ft)			
MQDC1-515RA	5 m (16.4 ft)			
MQDC1-530RA	9 m (29.5 ft)			

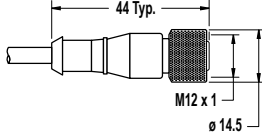
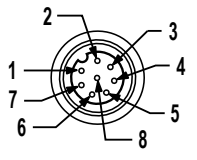
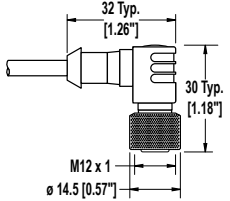
8-Pin Threaded M12 Cordsets with Open-Shield—Single Ended				
Model	Length	Style	Dimensions	Pinout (Female)
MQDC2S-806	2.04 m (6.7 ft)	Straight		 <p>1 = White 2 = Brown 3 = Green 4 = Yellow 5 = Gray 6 = Pink 7 = Blue 8 = Red</p>
MQDC2S-815	5.04 m (16.54 ft)			
MQDC2S-830	10.04 m (32.95 ft)			
MQDC2S-850	16 m (52.49 ft)			
MQDC2S-806RA	2 m (6.56 ft)	Right-Angle		
MQDC2S-815RA	5 m (16.4 ft)			
MQDC2S-830RA	10 m (32.81 ft)			
MQDC2S-850RA	16 m (52.49 ft)			

Mounting Brackets

All measurements are listed in millimeters, unless noted otherwise.

SMB30A

- Right-angle bracket with curved slot for versatile orientation
- Clearance for M6 (1/4 in) hardware
- Mounting hole for 30 mm sensor
- 12-ga. stainless steel

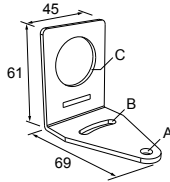

Hole center spacing: A to B=40

Hole size: A=∅ 6.3, B= 27.1 x 6.3, C=∅ 30.5

SMB30MM

- 12-ga. stainless steel bracket with curved mounting slots for versatile orientation
- Clearance for M6 (1/4 in) hardware
- Mounting hole for 30 mm sensor

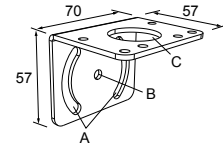

Hole center spacing: A = 51, A to B = 25.4

Hole size: A = 42.6 x 7, B = ∅ 6.4, C = ∅ 30.1

SMBAMS30P

- Flat SMBAMS series bracket
- 30 mm hole for mounting sensors
- Articulation slots for 90°+ rotation
- 12-ga. 300 series stainless steel

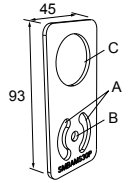

Hole center spacing: A=26.0, A to B=13.0

Hole size: A=26.8 x 7.0, B=∅ 6.5, C=∅ 31.0

SSA-MBK-EEC1

- Single 30 mm hole
- 8 gauge steel, black finish (powder coat)
- Front surface for customer applied labels

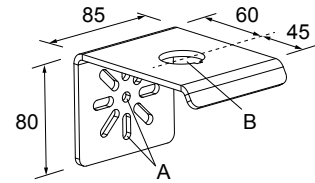

Hole size: A = ∅ 7, B = ∅ 30

LMBE12RA35

- Direct mounting of stand-off pipe, with common bracket type
- Zinc-plated steel
- 1/2-14 NPSM nut
- Mounting distance from the wall to the center of the 1/2-14 NPSM nut is 35 mm

Hole center spacing: 20.0

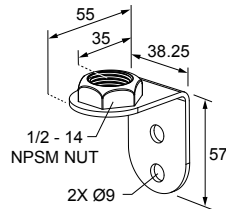



LMBE12RA45

- Direct mounting of stand-off pipe, with common bracket type
- Zinc-plated steel
- 1/2-14 NPSM nut
- Mounting distance from the wall to the center of the 1/2-14 NPSM nut is 45 mm

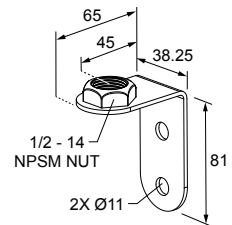
Hole center spacing: 35.0



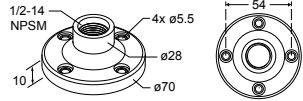
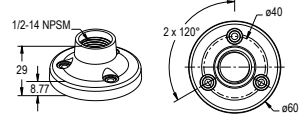

Elevated Mount System

Model			Features	Components
SA-M30 - Black Polycarbonate			<ul style="list-style-type: none"> Streamlined black PC or Gray PC thread cover Covers M30 thread on the light base Mounting hardware included 	
SA-M30C - Gray Polycarbonate				
Polished 304 Stainless Steel	Black Anodized Aluminum	Clear Anodized Aluminum	<ul style="list-style-type: none"> Elevated-use stand-off pipe (½ in. NPSM/DN15) Polished 304 stainless steel, black anodized aluminum, or clear anodized aluminum surface ½ in. NPT thread at both ends Compatible with most industrial environments 	
SOP-E12-150SS 150 mm (6 in) long	SOP-E12-150A 150 mm (6 in) long	SOP-E12-150AC 150 mm (6 in) long		
SOP-E12-300SS 300 mm (12 in) long	SOP-E12-300A 300 mm (12 in) long	SOP-E12-300AC 300 mm (12 in) long		
SOP-E12-900SS 900 mm (36 in) long	SOP-E12-900A 900 mm (36 in) long	SOP-E12-900AC 900 mm (36 in) long		
SA-E12M30 - Black Acetal			<ul style="list-style-type: none"> Streamlined black acetal or white UHMW mounting base adapter/cover Connects between ½ in. NPSM/DN15 pipe and 30 mm (1-3/16 in) drilled hole Mounting hardware included 	
SA-E12M30C - White UHMW				

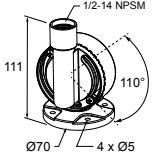
Pipe Mounting Flange			
Model	Features	Construction	
SA-F12	<ul style="list-style-type: none"> Elevated-use stand-off pipes (½ in, NPSM/DN15) M5 mounting hardware and nitrile gasket included 	Die-cast zinc base with black paint	
SA-F12-3	<ul style="list-style-type: none"> Elevated-use stand-off pipes (½ in, NPSM/DN15) M4 mounting hardware and nitrile blend gasket included 	Black Polycarbonate	

Foldable Mounting Brackets			
Model	Features	Construction	
SA-FFB12	<ul style="list-style-type: none"> For use with 1/2 inch stand-off pipes Stainless steel hardware 	Black polycarbonate	
SA-FFB12C		Gray polycarbonate	

LMB Sealed Right-Angle Bracket

Model	Description	Construction	
LMB30RA	Direct-Mount Models: Bracket kit with base, 30 mm adapter, set screw, fasteners, O-rings, and gaskets.	Black polycarbonate	
LMB30RAC		Gray polycarbonate	
LMBE12RA	Pipe-Mount Models: Bracket kit with base, ½-14 pipe adapter, set screw, fasteners, O-rings, and gaskets. For use with stand-off pipe (listed and sold separately).	Black polycarbonate	
LMBE12RAC		Gray polycarbonate	

Banner Engineering Corp. Limited Warranty

Banner Engineering Corp. warrants its products to be free from defects in material and workmanship for one year following the date of shipment. Banner Engineering Corp. will repair or replace, free of charge, any product of its manufacture which, at the time it is returned to the factory, is found to have been defective during the warranty period. This warranty does not cover damage or liability for misuse, abuse, or the improper application or installation of the Banner product.

THIS LIMITED WARRANTY IS EXCLUSIVE AND IN LIEU OF ALL OTHER WARRANTIES WHETHER EXPRESS OR IMPLIED (INCLUDING, WITHOUT LIMITATION, ANY WARRANTY OF MERCHANTABILITY OR FITNESS FOR A PARTICULAR PURPOSE), AND WHETHER ARISING UNDER COURSE OF PERFORMANCE, COURSE OF DEALING OR TRADE USAGE.

This Warranty is exclusive and limited to repair or, at the discretion of Banner Engineering Corp., replacement. **IN NO EVENT SHALL BANNER ENGINEERING CORP. BE LIABLE TO BUYER OR ANY OTHER PERSON OR ENTITY FOR ANY EXTRA COSTS, EXPENSES, LOSSES, LOSS OF PROFITS, OR ANY INCIDENTAL, CONSEQUENTIAL OR SPECIAL DAMAGES RESULTING FROM ANY PRODUCT DEFECT OR FROM THE USE OR INABILITY TO USE THE PRODUCT, WHETHER ARISING IN CONTRACT OR WARRANTY, STATUTE, TORT, STRICT LIABILITY, NEGLIGENCE, OR OTHERWISE.**

Banner Engineering Corp. reserves the right to change, modify or improve the design of the product without assuming any obligations or liabilities relating to any product previously manufactured by Banner Engineering Corp. Any misuse, abuse, or improper application or installation of this product or use of the product for personal protection applications when the product is identified as not intended for such purposes will void the product warranty. Any modifications to this product without prior express approval by Banner Engineering Corp will void the product warranties. All specifications published in this document are subject to change; Banner reserves the right to modify product specifications or update documentation at any time. Specifications and product information in English supersede that which is provided in any other language. For the most recent version of any documentation, refer to: www.bannerengineering.com.

For patent information, see www.bannerengineering.com/patents.