



FEATURES

- ◆ Alternate Source for MAX6025
- ◆ Initial Accuracy:
 - 0.2% (max) – TSM6025A
 - 0.4% (max) – TSM6025B
- ◆ Temperature Coefficient:
 - 15ppm/°C (max) – TSM6025A
 - 25ppm/°C (max) – TSM6025B
- ◆ Quiescent Supply Current: 35µA (max)
- ◆ Low Supply Current Change with V_{IN} : <1µA/V
- ◆ Output Source/Sink Current: ±500µA
- ◆ Low Dropout at 500µA Load Current: 100mV
- ◆ Load Regulation: 0.14µV/µA
- ◆ Line Regulation : 25µV/V
- ◆ Stable with C_{LOAD} up to 2200pF

APPLICATIONS

Industrial and Process-Control Systems
 Hard-Disk Drives
 Battery-Operated Equipment
 Data Acquisition Systems
 Hand-Held Equipment
 Precision 3V/5V Systems
 Smart Industrial Transmitters

DESCRIPTION

The TSM6025 is a 3-terminal, series-mode 2.5-V precision voltage reference and is a pin-for-pin, alternate source for the MAX6025 voltage reference. Like the MAX6025, the TSM6025 consumes only 27µA of supply current at no-load, exhibits an initial output voltage accuracy of less than 0.2%, and a low output voltage temperature coefficient of 15ppm/°C. In addition, the TSM6025's output stage is stable for all capacitive loads to 2200pF and is capable of sinking and sourcing load currents up to 500µA.

Since the TSM6025 is a series-mode voltage reference, its supply current is not affected by changes in the applied supply voltage unlike two-terminal shunt-mode references that require an external resistor. The TSM6025's small form factor and low supply current operation combine to make it an ideal choice in low-power, precision applications.

The TSM6025 is fully specified over the -40°C to +85°C temperature range and is available in a 3-pin SOT23 package.

TYPICAL APPLICATION CIRCUIT

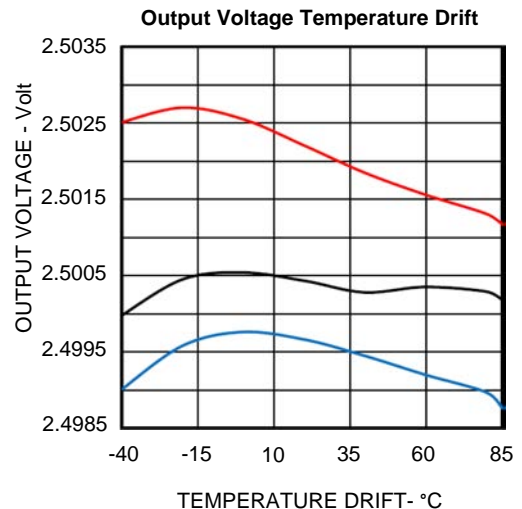
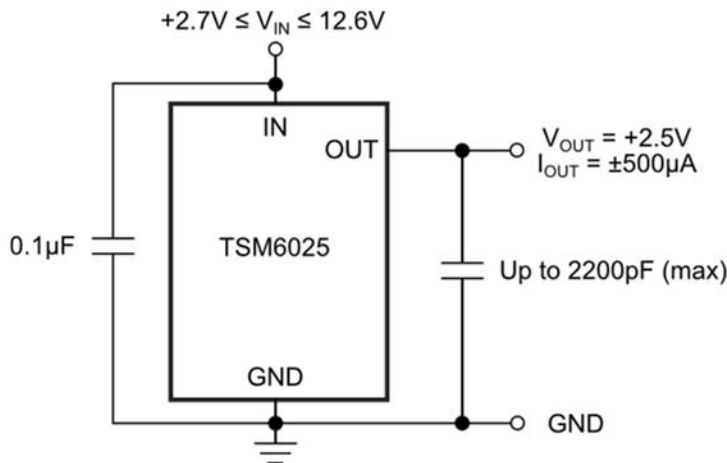

ABSOLUTE MAXIMUM RATINGS

IN to GND..... -0.3V to +13.5V
 OUT to GND..... -0.3V to 7V
 Short Circuit to GND or IN ($V_{IN} < 6V$)..... Continuous
 Output Short Circuit to GND or IN ($V_{IN} \geq 6V$) 60s
 Continuous Power Dissipation ($T_A = +70^\circ C$)
 3-Pin SOT23 (Derate at 4.0mW/°C above +70°C)..... 320mW

Operating Temperature Range..... -40°C to +85°C
 Storage Temperature Range..... -65°C to +150°C
 Lead Temperature (Soldering, 10s)..... +300°C

Electrical and thermal stresses beyond those listed under “Absolute Maximum Ratings” may cause permanent damage to the device. These are stress ratings only and functional operation of the device at these or any other condition beyond those indicated in the operational sections of the specifications is not implied. Exposure to any absolute maximum rating conditions for extended periods may affect device reliability and lifetime.

PACKAGE/ORDERING INFORMATION

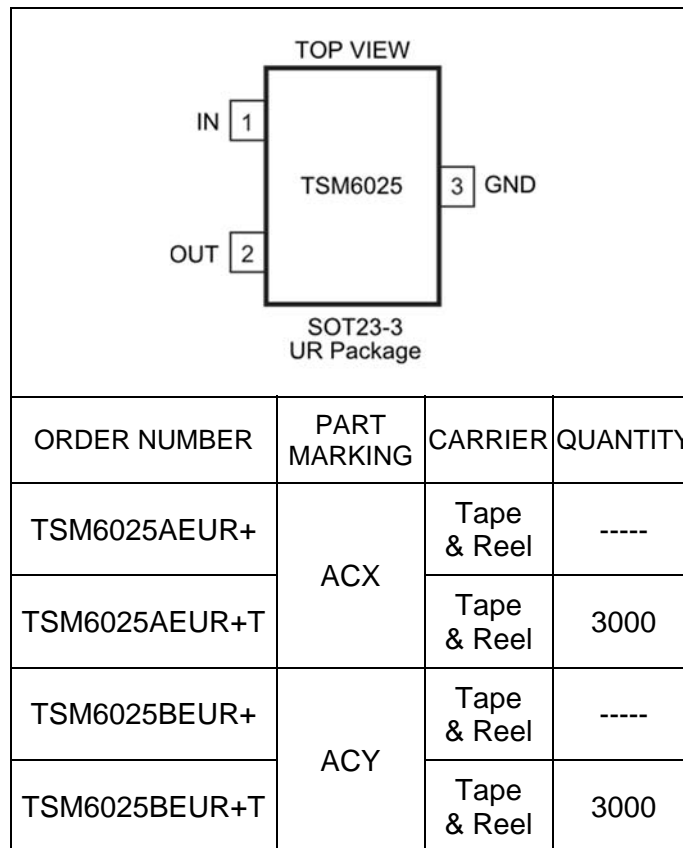

Lead-free Program: Silicon Labs supplies only lead-free packaging.

Consult Silicon Labs for products specified with wider operating temperature ranges.

ELECTRICAL CHARACTERISTICS

$V_{IN} = +5V$, $I_{OUT} = 0$, $T_A = T_{MIN}$ to T_{MAX} , unless otherwise noted. Typical values are at $T_A = +25^\circ C$. See Note 1.

PARAMETER	SYMBOL	CONDITIONS	MIN	TYP	MAX	UNITS	
OUTPUT							
Output Voltage	V_{OUT}	$T_A = +25^\circ C$	TSM6025A	2.495	2.500	2.505	V
				-0.20		0.20	%
			TSM6025B	2.490	2.500	2.510	V
				-0.40		0.40	%
Output Voltage Temperature Coefficient (See Note 2)	V_{OUT}		TSM6025A	$T_A = 0^\circ C$ to $+70^\circ C$	6	15	ppm/ $^\circ C$
				$T_A = -40^\circ C$ to $+85^\circ C$	6	20	
			TSM6025B	$T_A = 0^\circ C$ to $+70^\circ C$	6	25	
				$T_A = -40^\circ C$ to $+85^\circ C$	6	30	
Line Regulation	$\frac{\Delta V_{OUT}}{\Delta V_{IN}}$	$(V_{OUT} + 0.2V) \leq V_{IN} \leq 12.6V$			140	$\mu V/V$	
Load Regulation	$\frac{\Delta V_{OUT}}{\Delta I_{OUT}}$	Sourcing: $0 \leq I_{OUT} \leq 500\mu A$ Sinking: $-500\mu A \leq I_{OUT} \leq 0$		0.14	0.60	$\mu V/\mu A$	
				0.18	0.80		
Dropout Voltage (See Note 5)	$V_{IN} - V_{OUT}$	$I_{OUT} = 500\mu A$		100	200	mV	
OUT Short-Circuit Current	I_{SC}	V_{OUT} Short to GND V_{OUT} Short to IN		4		mA	
				4			
Temperature Hysteresis (See Note 3)				130		ppm	
Long-Term Stability	$\frac{\Delta V_{OUT}}{\text{time}}$	1000hr at $T_A = +25^\circ C$		50		ppm/1000hr	
DYNAMIC							
Noise Voltage	e_{OUT}			50		μV_{P-P}	
				125		μV_{RMS}	
Ripple Rejection	$\frac{\Delta V_{OUT}}{\Delta V_{IN}}$	$V_{IN} = 5V \pm 100mV$, $f = 120Hz$		82		dB	
Capacitive-Load Stability Range	C_{OUT}	See Note 4	0		2.2	nF	
INPUT							
Supply Voltage Range	V_{IN}	Guaranteed by line-regulation test	$V_{OUT} + 0.2$		12.6	V	
Quiescent Supply Current	I_{IN}			27	35	μA	
Change in Supply Current	I_{IN}/V_{IN}	$(V_{OUT} + 0.2V) \leq V_{IN} \leq 12.6V$			2.0	$\mu A/V$	

Note 1: All devices are 100% production tested at $T_A = +25^\circ C$ and are guaranteed by characterization for $T_A = T_{MIN}$ to T_{MAX} , as specified.

Note 2: Temperature Coefficient is measured by the "box" method; i.e., the maximum ΔV_{OUT} is divided by the maximum ΔT .

Note 3: Temperature hysteresis is defined as the change in the $+25^\circ C$ output voltage before and after cycling the device from T_{MIN} to T_{MAX} .

Note 4: Not production tested; guaranteed by design.

Note 5: Dropout voltage is the minimum input voltage at which V_{OUT} changes $\leq 0.2\%$ from V_{OUT} at $V_{IN} = 5.0V$.

TYPICAL PERFORMANCE CHARACTERISTICS

$V_{IN} = +5V$; $I_{OUT} = 0mA$; $T_A = +25^{\circ}C$, unless otherwise noted.

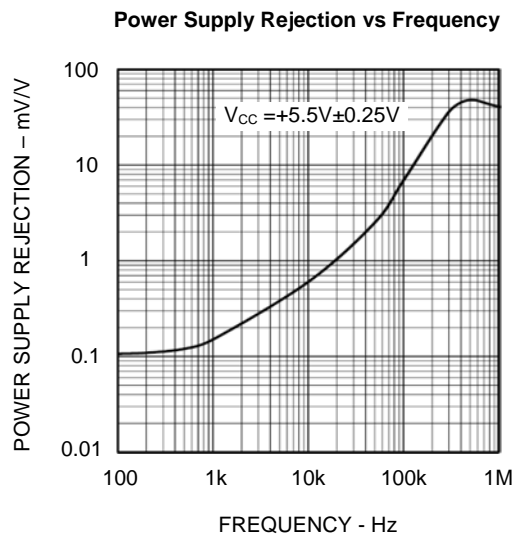
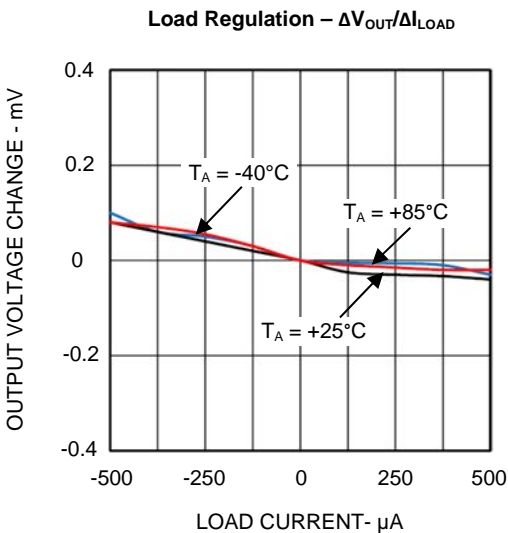
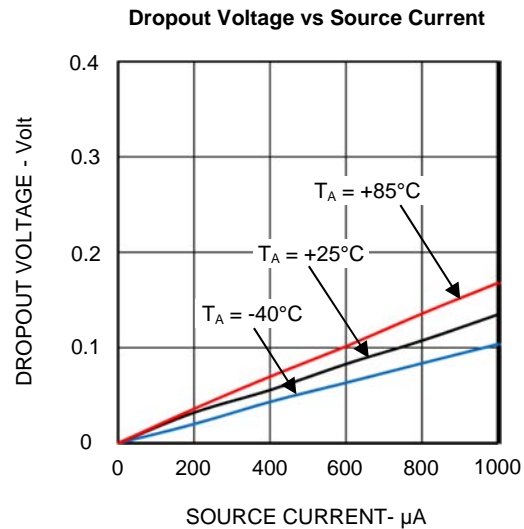
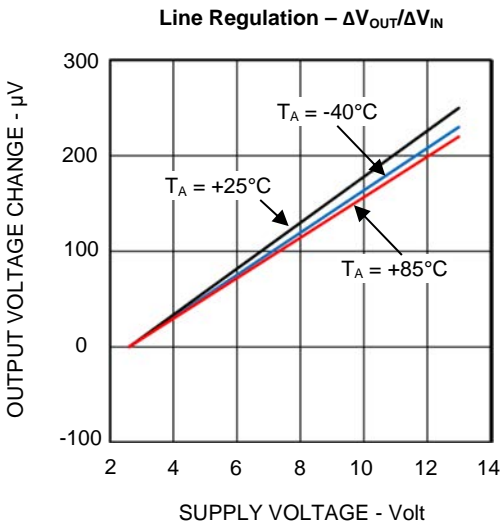
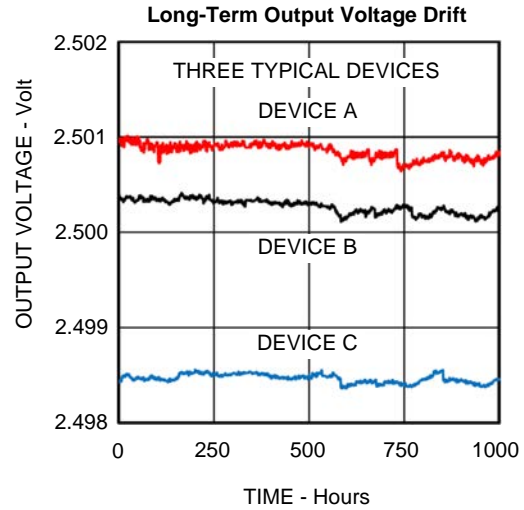
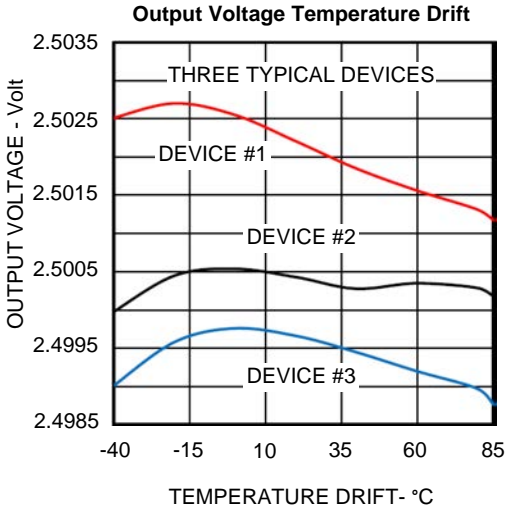

TYPICAL PERFORMANCE CHARACTERISTICS

$V_{IN} = +5V$; $I_{OUT} = 0mA$; $T_A = +25^{\circ}C$, unless otherwise noted.

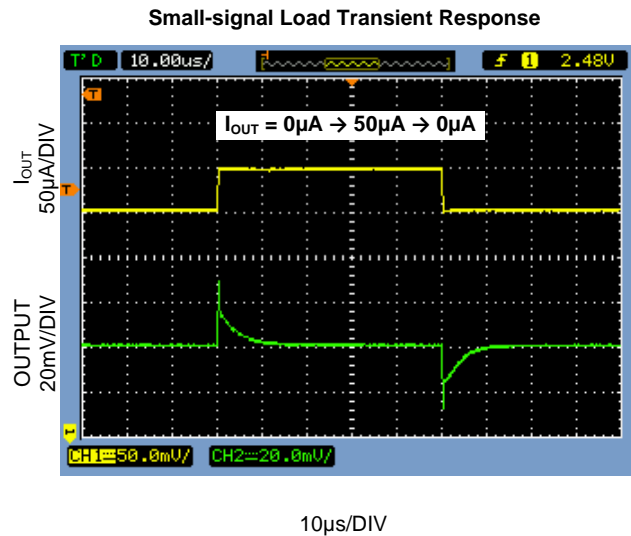
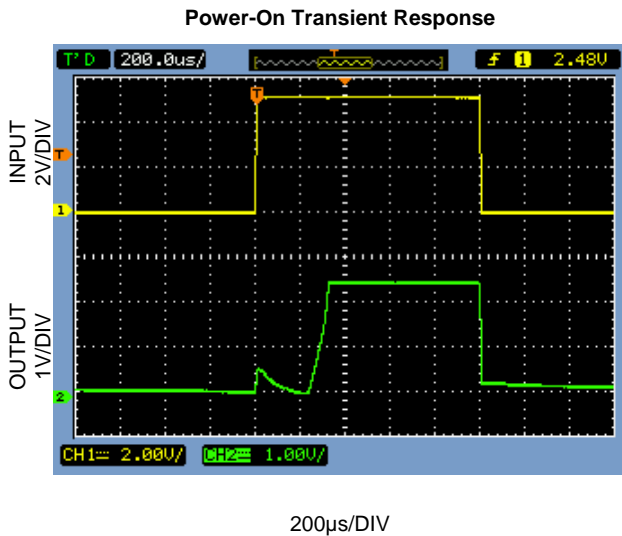
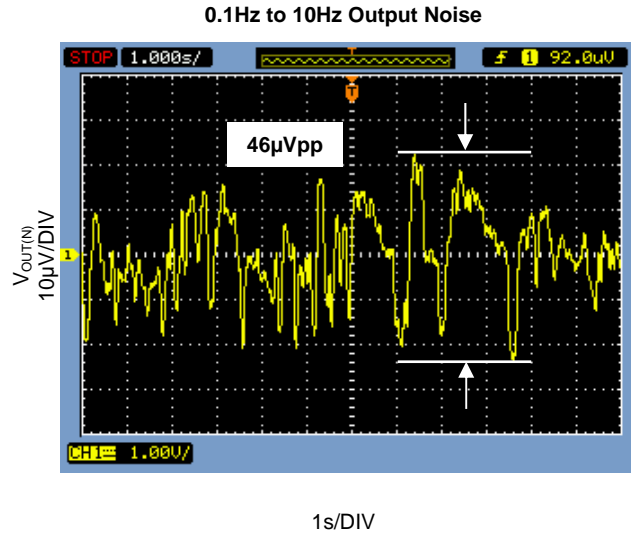
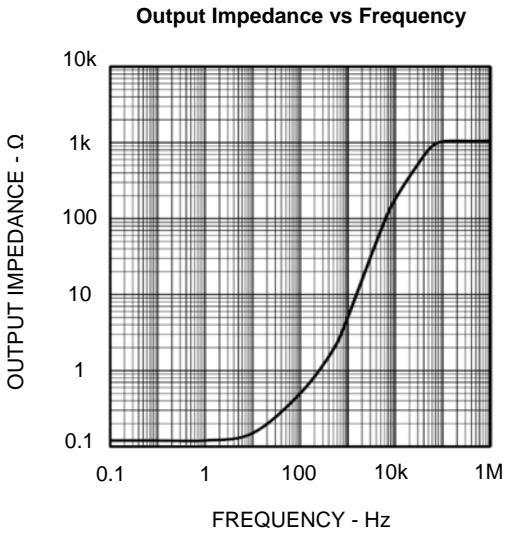
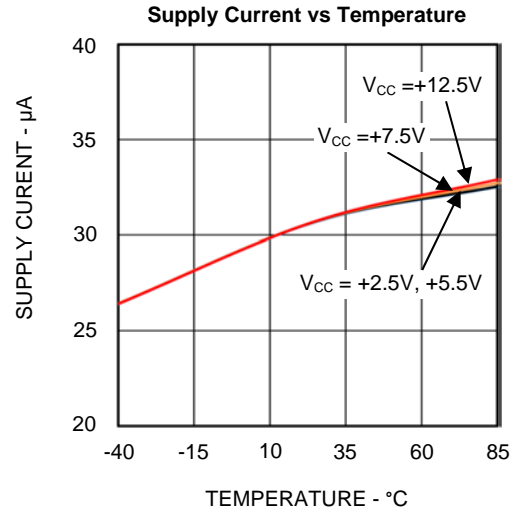
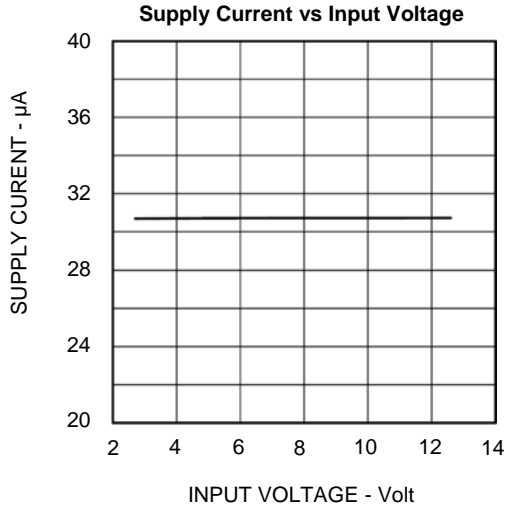

TYPICAL PERFORMANCE CHARACTERISTICS

$V_{IN} = +5V$; $I_{OUT} = 0mA$; $T_A = +25^{\circ}C$, unless otherwise noted.

Large-signal Load Transient Response

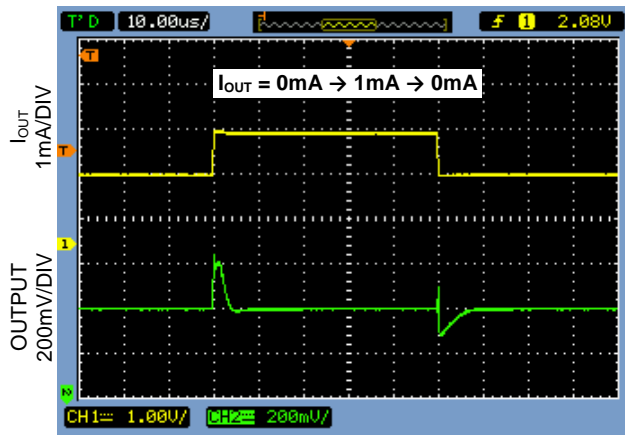

10 μ s/DIV

Line Transient Response

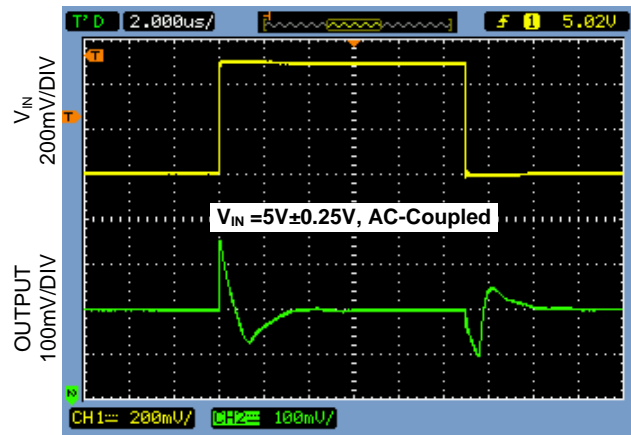

2 μ s/DIV

PIN FUNCTIONS

PIN	NAME	FUNCTION
1	IN	Supply Voltage Input
2	OUT	+2.5V Output
3	GND	Ground

DESCRIPTION/THEORY OF OPERATION

The TSM6025 incorporates a precision 1.25-V bandgap reference that is followed by a output amplifier configured to amplify the base bandgap output voltage to a 2.5-V output. The design of the bandgap reference incorporates proprietary circuit design techniques to achieve its low temperature coefficient of 15ppm/°C and initial output voltage accuracy less than 0.2%. The design of the output

amplifier's frequency compensation does not require a separate compensation capacitor and is stable with capacitive loads up to 2200pF. The design of the output amplifier also incorporates low headroom design as it can source and sink load currents to 500µA with a dropout voltage less than 200mV.

APPLICATIONS INFORMATION

Power Supply Input Capacitive Bypass

As shown in the Typical Application Circuit, the V_{IN} pin of the TSM6025 should be bypassed to GND with a 0.1µF ceramic capacitor for optimal line-transient performance. Consistent with good analog circuit engineering practice, the capacitor should be placed in as close proximity to the TSM6025 as practical with very short pcb track lengths.

Output/Load Capacitance Considerations

As mentioned previously, the TSM6025 does not require a separate, external capacitor at V_{OUT} for transient response stability as it is stable for capacitive loads up to 2200pF. On the other hand and for improved large-signal line and load regulation, the use of a capacitor at V_{OUT} will provide a reservoir of charge in reserve to absorb large-signal load or line transients. This in turn improves the TSM6025's V_{OUT} settling time. If large load and line transients are not expected in the application, then the TSM6025 can be used without an external capacitor at V_{OUT} thereby reducing the overall circuit footprint.

Supply Current

The TSM6025 exhibits excellent dc line regulation as its supply current changes slightly as the applied supply voltage is increased. While its supply current is 35µA maximum, the change in its supply current as a function of supply voltage (its $\Delta I_{IN}/\Delta V_{IN}$) is less

than 1µA/V. Since the TSM6025 is a series-mode reference, load current is drawn from the supply voltage only when required. In this case, circuit efficiency is maintained at all applied supply voltages. Reducing power dissipation and extending battery life are the net benefits of improved circuit efficiency.

On the other hand, an external resistor in series with the supply voltage is required by two-terminal, shunt-mode references. In this case, as the supply voltage changes, so does the quiescent supply current of the shunt reference. In addition, the external resistor's tolerance and temperature coefficient contribute two additional factors that can affect the circuit's supply current. Therefore, maximizing circuit efficiency with shunt-mode references becomes an exercise involving three variables. Additionally, shunt-mode references must be biased at the maximum expected load current even if the load current is not present at all times.

When the applied supply voltage is less than the minimum specified input voltage of the TSM6025 (for example, during the power-up transition), the TSM6025 can draw up to 200µA above its nominal, steady-state supply current. To ensure reliable power-up behavior, the input power source must have sufficient reserve power to provide the extra supply current drawn during the power-up transition.

Output Voltage Hysteresis

Reference output voltage thermal hysteresis is the change in the reference's +25°C output voltage after temperature cycling from +85°C to +25°C and from -40°C to +25°C. Thermal hysteresis is caused by differential package stress impressed upon the TSM6025's internal bandgap core transistors and depends on whether the reference IC was previously at a higher or lower temperature. At 130ppm, the TSM6025's typical temperature hysteresis is equal to 0.33mV with respect to a 2.5V output voltage.

Voltage Reference Turn-On Time

With a $(V_{IN} - V_{OUT})$ voltage differential larger than 200mV and $I_{LOAD} = 0mA$, the TSM6025's typical

combined turn-on and settling time to within 0.1% of its 2.5V final value is approximately 340µs.

A Positive and Negative Low-Power Voltage Reference

The circuit in Figure 1 uses a CD4049 hex inverter and a few external capacitors as the power supply to a dual-supply precision op amp to form a ±2.5V precision, bipolar output voltage reference around the TSM6025. The CD4049-based circuit is a discrete charge pump voltage doubler/inverter that generates ±6V supplies for any industry-standard OP-07 or equivalent precision op amp.

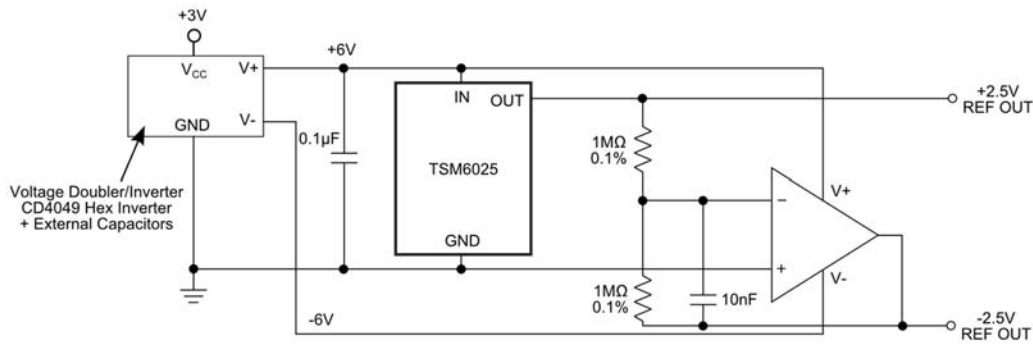

Figure 1: Positive and Negative 2.5V References from a Single +3V or +5V Supply



PACKAGE OUTLINE DRAWING

3-Pin SOT23 Package Outline Drawing

(N.B., Drawings are not to scale)

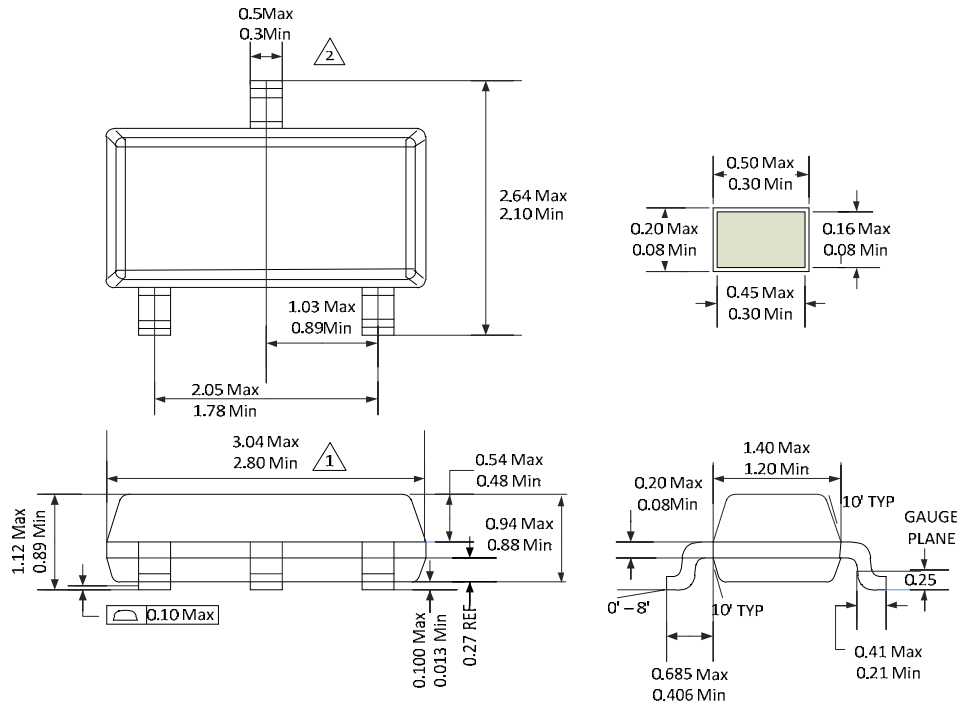

NOTE:

- 1 Does not include mode flash, protrusions or gate burns. Mode flash, protrusions or gate burns shall not exceed 0.127 mm per side
- 2 Does not include inter-lead flash or protrusions. Inter-lead flash and protrusions shall not exceed 0.127 mm per side.
- 3 Die is facing up for mold die and trim-form.
- 4 Lead span/stand of high/coplanarity are considered as special characteristic.
- 5 All specifications refer JEDEC TO-236AB except for lead length dimension.
- 6 Controlling dimension in (mm)

Patent Notice

Silicon Labs invests in research and development to help our customers differentiate in the market with innovative low-power, small size, analog-intensive mixed-signal solutions. Silicon Labs' extensive patent portfolio is a testament to our unique approach and world-class engineering team.

The information in this document is believed to be accurate in all respects at the time of publication but is subject to change without notice. Silicon Laboratories assumes no responsibility for errors and omissions, and disclaims responsibility for any consequences resulting from the use of information included herein. Additionally, Silicon Laboratories assumes no responsibility for the functioning of undescribed features or parameters. Silicon Laboratories reserves the right to make changes without further notice. Silicon Laboratories makes no warranty, representation or guarantee regarding the suitability of its products for any particular purpose, nor does Silicon Laboratories assume any liability arising out of the application or use of any product or circuit, and specifically disclaims any and all liability, including without limitation consequential or incidental damages. Silicon Laboratories products are not designed, intended, or authorized for use in applications intended to support or sustain life, or for any other application in which the failure of the Silicon Laboratories product could create a situation where personal injury or death may occur. Should Buyer purchase or use Silicon Laboratories products for any such unintended or unauthorized application, Buyer shall indemnify and hold Silicon Laboratories harmless against all claims and damages.

Silicon Laboratories and Silicon Labs are trademarks of Silicon Laboratories Inc. Other products or brandnames mentioned herein are trademarks or registered trademarks of their respective holders.

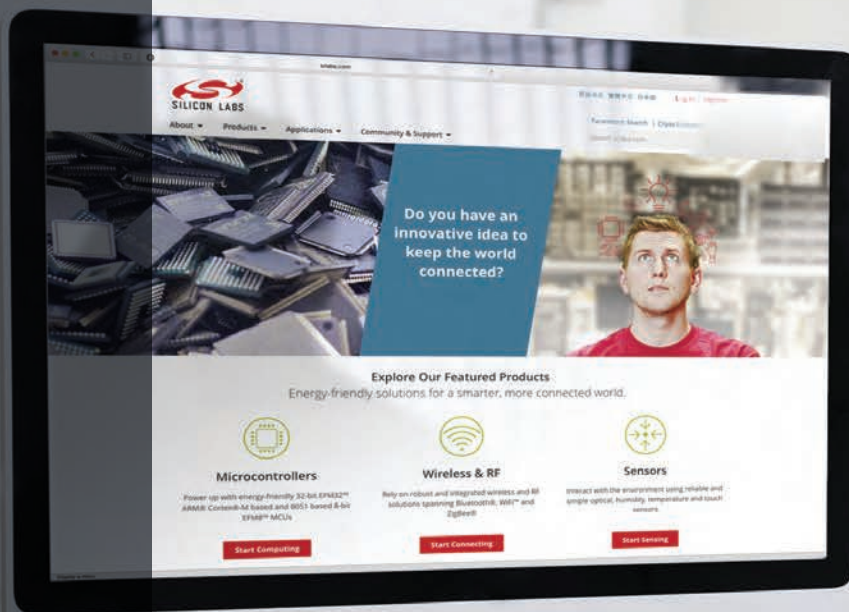

Smart.
Connected.
Energy-Friendly



Products
www.silabs.com/products

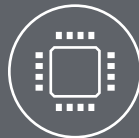

Quality
www.silabs.com/quality



Support and Community
community.silabs.com

Disclaimer

Silicon Laboratories intends to provide customers with the latest, accurate, and in-depth documentation of all peripherals and modules available for system and software implementers using or intending to use the Silicon Laboratories products. Characterization data, available modules and peripherals, memory sizes and memory addresses refer to each specific device, and "Typical" parameters provided can and do vary in different applications. Application examples described herein are for illustrative purposes only. Silicon Laboratories reserves the right to make changes without further notice and limitation to product information, specifications, and descriptions herein, and does not give warranties as to the accuracy or completeness of the included information. Silicon Laboratories shall have no liability for the consequences of use of the information supplied herein. This document does not imply or express copyright licenses granted hereunder to design or fabricate any integrated circuits. The products must not be used within any Life Support System without the specific written consent of Silicon Laboratories. A "Life Support System" is any product or system intended to support or sustain life and/or health, which, if it fails, can be reasonably expected to result in significant personal injury or death. Silicon Laboratories products are generally not intended for military applications. Silicon Laboratories products shall under no circumstances be used in weapons of mass destruction including (but not limited to) nuclear, biological or chemical weapons, or missiles capable of delivering such weapons.

Trademark Information

Silicon Laboratories Inc., Silicon Laboratories, Silicon Labs, SiLabs and the Silicon Labs logo, CMEMS®, EFM, EFM32, EFR, Energy Micro, Energy Micro logo and combinations thereof, "the world's most energy friendly microcontrollers", Ember®, EZLink®, EZMac®, EZRadio®, EZRadioPRO®, DSPLL®, ISOmodem®, Precision32®, ProSLIC®, SiPHY®, USBXpress® and others are trademarks or registered trademarks of Silicon Laboratories Inc. ARM, CORTEX, Cortex-M3 and THUMB are trademarks or registered trademarks of ARM Holdings. Keil is a registered trademark of ARM Limited. All other products or brand names mentioned herein are trademarks of their respective holders.



Silicon Laboratories Inc.
400 West Cesar Chavez
Austin, TX 78701
USA

<http://www.silabs.com>