



OPA2677



For most current data sheet and other product information, visit www.burr-brown.com

SpeedPLUS™ Dual, Wideband, High Output Current OPERATIONAL AMPLIFIER

FEATURES

- WIDEBAND +12V OPERATION: 200MHz (G = +4)
- UNITY GAIN STABLE: 220MHz (G = 1)
- HIGH OUTPUT CURRENT: 500mA
- OUTPUT VOLTAGE SWING: $\pm 5V$
- HIGH SLEW RATE: 1800V/ μs
- LOW SUPPLY CURRENT: 18mA
- FLEXIBLE POWER CONTROL

APPLICATIONS

- xDSL LINE DRIVER
- CABLE MODEM DRIVER
- MATCHED I/Q CHANNEL AMPLIFIER
- BROADBAND VIDEO LINE DRIVER
- ARB LINE DRIVER
- PERFORMANCE UPGRADE TO AD8017

DESCRIPTION

The OPA2677 provides the high output current and low distortion required in emerging ADSL and HDSL2 driver applications. Operating on a single +12V supply, the OPA2677 consumes a low 9mA/chan quiescent current to deliver a very high 500mA peak output current. Guaranteed output current supports even the most demanding ADSL CPE requirements with > 380mA minimum output current with low harmonic distortion. Differential driver applications will deliver < -85dBc distortion at the peak upstream power levels of full rate ADSL. The high 200MHz bandwidth will also support the most demanding VDSL line driver requirements.

Power control features are included in the SO-14 package version to allow system power to be minimized. Two logic control lines allow four quiescent power settings. These include full power, power cutback for short loops, idle state for no signal transmission but line match maintenance, and shutdown for power off with a high impedance output.

Specified on $\pm 6V$ supplies (to support +12V operation), the OPA2677 will also support a single +5V or dual $\pm 5V$ supply. Video applications will benefit from its very high output current to drive up to 10 parallel video loads (15 Ω) with < 0.1% / 0.1° dG/d \emptyset non-linearity.

OPA2677 RELATED PRODUCTS

SINGLES	DUALS	TRIPLES	NOTES
OPA681	OPA2681	OPA3681	Single +12V Capable
—	OPA2607	—	$\pm 12V$ Capable

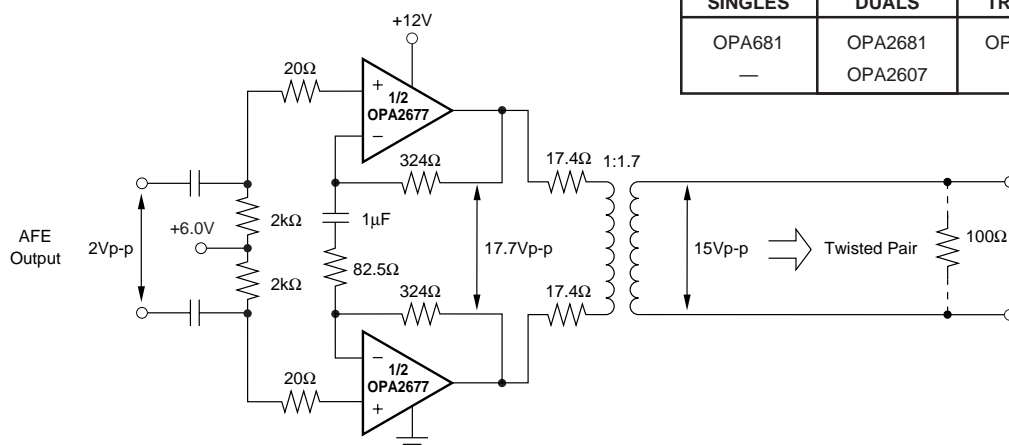

Single Supply ADSL Upstream Driver

International Airport Industrial Park • Mailing Address: PO Box 11400, Tucson, AZ 85734 • Street Address: 6730 S. Tucson Blvd., Tucson, AZ 85706 • Tel: (520) 746-1111
 Twx: 910-952-1111 • Internet: <http://www.burr-brown.com/> • Cable: BBRCORP • Telex: 066-6491 • FAX: (520) 889-1510 • Immediate Product Info: (800) 548-6132

SPECIFICATIONS: $V_S = +5V$

At $T_A = +25^\circ C$, $G = +2$, $R_F = 453\Omega$, and $R_L = 100\Omega$, unless otherwise noted. See Figure 2 for AC performance only

PARAMETER	CONDITIONS	OPA2677U, H, N						TEST LEVEL ⁽¹⁾
		TYP	GUARANTEED					
		+25°C	+25°C ⁽²⁾	0°C to 70°C ⁽³⁾	-40°C to +85°C ⁽³⁾	UNITS	MIN/MAX	
AC PERFORMANCE (Figure 2)								
Small-Signal Bandwidth ($V_O = 0.5V_{p-p}$)	$G = +1, R_F = 536\Omega$	160				MHz	typ	C
	$G = +2, R_F = 511\Omega$	150				MHz	typ	C
	$G = +4, R_F = 453\Omega$	160				MHz	typ	C
	$G = +8, R_F = 332\Omega$	160				MHz	typ	C
Bandwidth for 0.1dB Gain Flatness	$G = +4, V_O = 0.5V_{p-p}$	70				MHz	typ	C
Large-Signal Bandwidth	$G = +4, V_O = 2V_{p-p}$	100				MHz	typ	C
Slew Rate	$G = +4, 2V$ Step	1100				V/ μs	typ	C
Rise/Fall Time	$G = +4, V_O = 2V$ Step	2				ns	typ	C
Spurious Free Dynamic Range	$V_O = 2V_{p-p}, 5MHz, 100\Omega$	67				dB	typ	C
	$V_O = 2V_{p-p}, 100kHz, 100\Omega$	87				dB	typ	C
Input Voltage Noise		2.0				nV/ \sqrt{Hz}	typ	C
Non-Inverting Input Current Noise		14				pA/ \sqrt{Hz}	typ	C
Inverting Input Current Noise		21				pA/ \sqrt{Hz}	typ	C
Channel-to-Channel Crosstalk	$f = 5MHz, Input$ Referred	-80				dB	typ	C
DC PERFORMANCE⁽⁴⁾								
Open-Loop Transimpedance Gain	$V_O = 0V, R_L = 100\Omega$	125	90	85	80	k Ω	min	A
Input Offset Voltage	$V_{CM} = 0V$	± 0.8	± 4.0	± 5.5	± 6.0	mV	max	A
Average Offset Voltage Drift	$V_{CM} = 0V$			35	40	$\mu V/^\circ C$	max	B
Non-Inverting Input Bias Current	$V_{CM} = 0V$	± 10	± 30	± 45	± 55	μA	max	A
Average Non-Inverting Input Bias Current Drift	$V_{CM} = 0V$			250	350	nA/ $^\circ C$	max	B
Inverting Input Bias Current	$V_{CM} = 0V$	± 10	± 30	± 45	± 55	μA	max	A
Average Inverting Input Bias Current Drift	$V_{CM} = 0V$			250	350	nA/ $^\circ C$	max	B
INPUT⁽⁴⁾								
Most Positive Input Voltage		3.7	3.4	3.3	3.2	V	min	A
Least Positive Input Voltage		1.3	1.6	1.7	1.8	V	max	A
Common-Mode Rejection Ratio (CMRR)	$V_{CM} = 2.5V, Input$ Referred	52	50	49	48	dB	min	A
Non-Inverting Input Impedance		250 2				k Ω pF	typ	C
Minimum Inverting Input Resistance	Open-Loop	29	20			Ω	min	B
Maximum Inverting Input Resistance	Open-Loop	29	37			Ω	max	B
OUTPUT⁽⁴⁾								
Most Positive Output Voltage	No Load	4.2	4.0	3.9	3.7	V	min	A
	$R_L = 100\Omega$	4.0	3.9	3.8	3.6	V	min	A
Least Positive Output Voltage	No Load	0.8	1.0	1.1	1.3	V	max	A
	$R_L = 100\Omega$	1.0	1.1	1.2	1.5	V	max	A
Current Output, Sourcing	$V_O = 2.5V$	300	200	160	120	mA	min	A
Current Output, Sinking	$V_O = 2.5V$	300	200	160	120	mA	min	A
Closed-Loop Output Impedance	$G = +4, f = 100kHz$	0.02				Ω	typ	C
Power Control (SO-14 only)								
Maximum Logic 0	A0, A1	1.8	1.0			V	max	A
Minimum Logic 1	A0, A1	2.3	2.6			V	min	A
Logic Input Current	A0 = A1 = 0	50	100			μA	max	A
Supply Current at Full Power	A0 = 1, A1 = 1	13.5				mA	typ	C
Supply Current at Power Cutback	A0 = 0, A1 = 1	11				mA	typ	C
Supply Current at Idle Power	A0 = 1, A1 = 0	2				mA	typ	C
Supply Current at Shutdown	A0 = 0, A1 = 0	0.8				mA	typ	C
Output Impedance in Idle Power	$G = +4, f = 100kHz$	0.1				Ω	typ	C
Output Impedance in Shutdown		100 4				k Ω pF	typ	C
Supply Current Step Time	10% to 90% Change	200				ns	typ	C
Output Switching Glitch	Inputs at GND	± 20				mV	typ	C
Shutdown Isolation	$G = +4, 1MHz, A0 = 0, A1 = 0$	85				dB	typ	C
POWER SUPPLY								
Specified Operating Voltage		+5				V	typ	C
Maximum Operating Voltage			+12.6	+12.6	+12.6	V	max	A
Maximum Quiescent Current	$V_S = +5V, Full$ Power	13.5	14.5	15	15.5	mA	max	A
Minimum Quiescent Current	$V_S = +5V, Full$ Power	13.5	12.5	12	11.5	mA	min	A
Power Supply Rejection Ratio (PSRR)	$f = 100kHz, Input$ Referred	52				dB	typ	C
TEMPERATURE RANGE								
Specification: U, N		-40 to +85				$^\circ C$		
Thermal Resistance, θ_{JA}	Junction-to-Ambient	125				$^\circ C/W$		
U SO-8		55				$^\circ C/W$		
H PSO-8		100				$^\circ C/W$		
N SO-14								

NOTES: (1) Test Levels: (A) 100% tested at 25°C. Over temperature limits by characterization and simulation. (B) Limits set by characterization and simulation. (C) Typical value only for information. (2) Junction temperature = ambient for 25°C guaranteed specifications. (3) Junction temperature = ambient at low temperature limit; junction temperature = ambient +23°C at high temperature limit for over temperature guaranteed specifications. (4) Current is considered positive-out-of node. V_{CM} is the input common-mode voltage. (5) Tested < 3dB below minimum specified CMRR at \pm CMIR limits.

ABSOLUTE MAXIMUM RATINGS

Power Supply	$\pm 6.5\text{VDC}$
Internal Power Dissipation ⁽¹⁾	See Thermal Information
Differential Input Voltage	$\pm 1.2\text{V}$
Input Voltage Range	$\pm V_S$
Storage Temperature Range: U, N, H	-40°C to $+125^\circ\text{C}$
Lead Temperature (soldering, 10s)	$+300^\circ\text{C}$
Junction Temperature (T_J)	$+175^\circ\text{C}$

NOTE: (1) Packages must be derated based on specified θ_{JA} . Maximum T_J must be observed.



ELECTROSTATIC DISCHARGE SENSITIVITY

Electrostatic discharge can cause damage ranging from performance degradation to complete device failure. Burr-Brown Corporation recommends that all integrated circuits be handled and stored using appropriate ESD protection methods.

ESD damage can range from subtle performance degradation to complete device failure. Precision integrated circuits may be more susceptible to damage because very small parametric changes could cause the device not to meet published specifications.

PIN CONFIGURATIONS

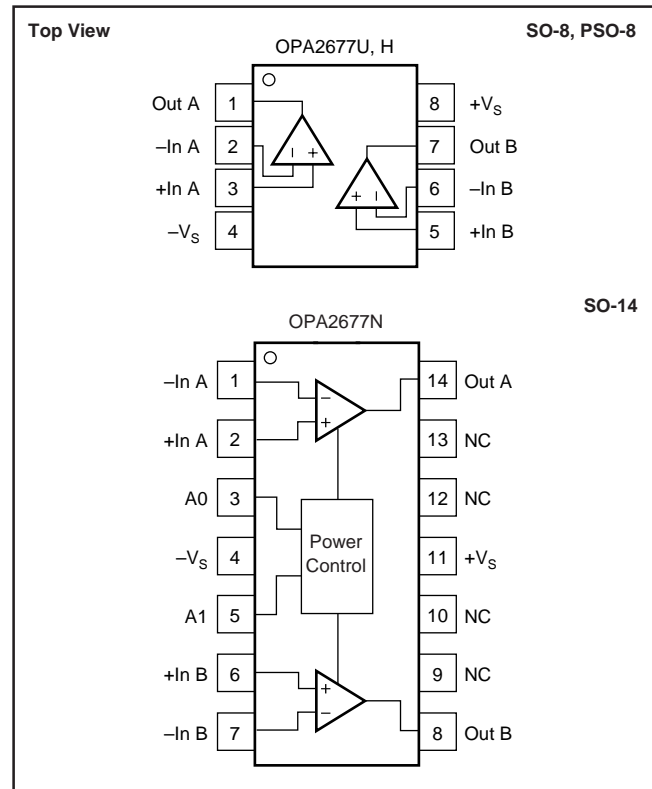

PACKAGE/ORDERING INFORMATION

PRODUCT	PACKAGE	PACKAGE DRAWING NUMBER	SPECIFIED TEMPERATURE RANGE	PACKAGE MARKING	ORDERING NUMBER ⁽¹⁾	TRANSPORT MEDIA
OPA2677U	SO-8 Surface Mount	182	-40°C to $+85^\circ\text{C}$	OPA2677U	OPA2677U	Rails
"	"	"	"	"	OPA2677U/2K5	Tape and Reel
OPA2677H	PSO-8 Surface Mount	182-1	-40°C to $+85^\circ\text{C}$	OPA2677H	—	Rails
"	"	"	"	"	—	Tape and Reel
OPA2677N	SO-14 Surface Mount	235	-40°C to -85°C	OPA2677N	—	Rails
"	"	"	"	"	—	Tape and Reel

NOTE: (1) Models with a slash (/) are available only as Tape and Reel in the quantity indicated after the slash (e.g. /2K5 indicates 2500 devices per reel). Ordering 2500 pieces of the OPA2677U/2K5 will get a single 2500-piece Tape and Reel.

The information provided herein is believed to be reliable; however, BURR-BROWN assumes no responsibility for inaccuracies or omissions. BURR-BROWN assumes no responsibility for the use of this information, and all use of such information shall be entirely at the user's own risk. Prices and specifications are subject to change without notice. No patent rights or licenses to any of the circuits described herein are implied or granted to any third party. BURR-BROWN does not authorize or warrant any BURR-BROWN product for use in life support devices and/or systems.

TYPICAL PERFORMANCE CURVES: $V_S = \pm 6V$

At $T_A = +25^\circ C$, $G = +4$, $R_F = 402\Omega$, and $R_L = 100\Omega$, unless otherwise noted. See Figure 1 for AC performance only

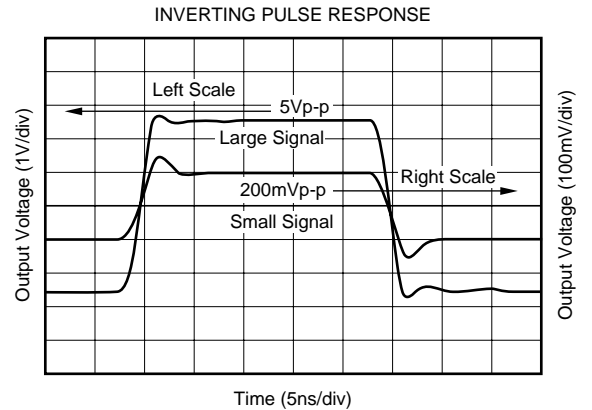
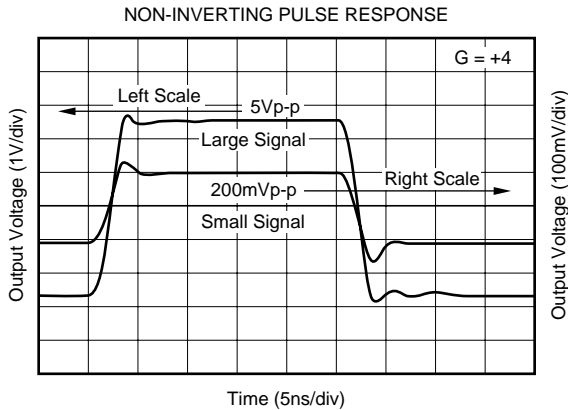
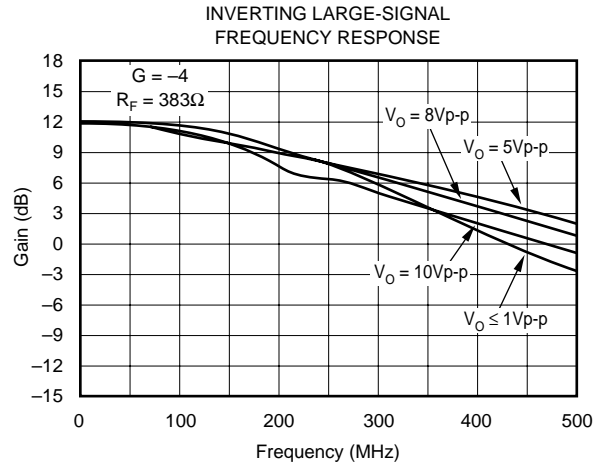
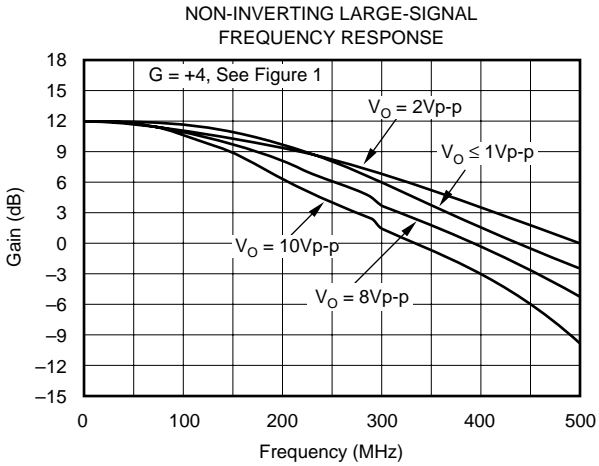
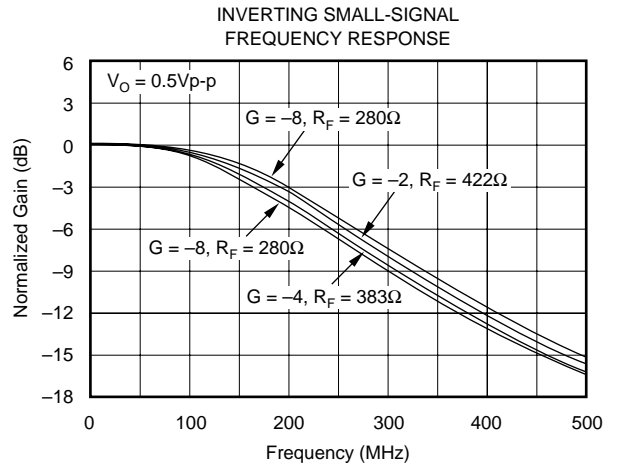
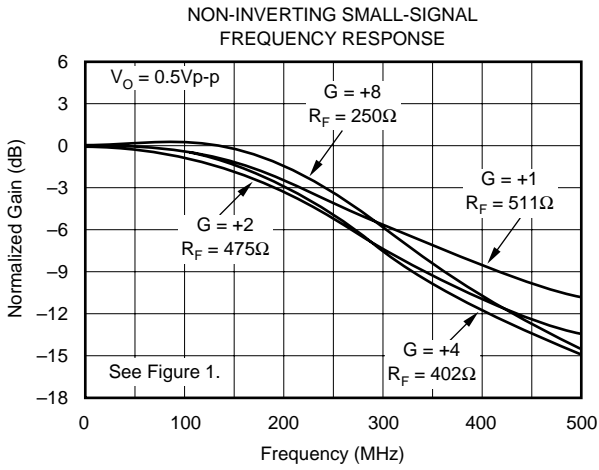

TYPICAL PERFORMANCE CURVES: $V_S = \pm 6V$ (Cont.)

At $T_A = +25^\circ C$, $G = +4$, $R_F = 402\Omega$, and $R_L = 100\Omega$, unless otherwise noted. See Figure 1 for AC performance only

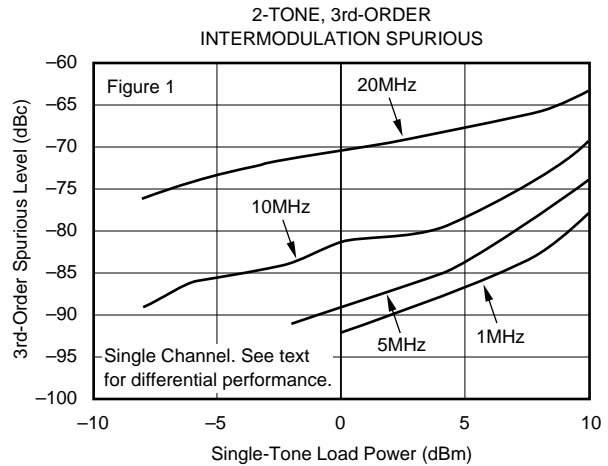
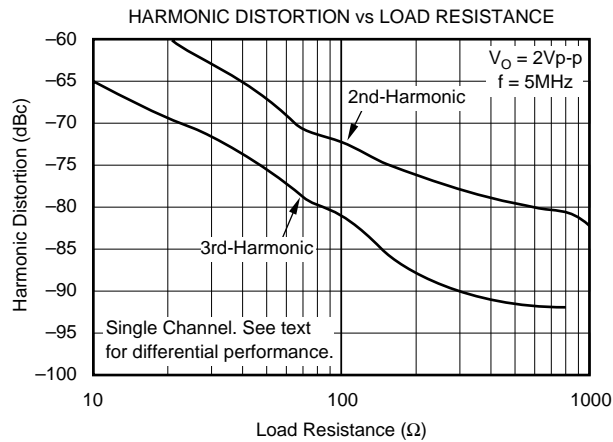
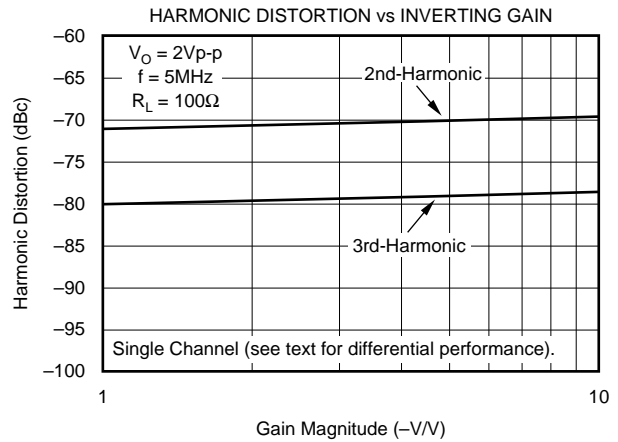
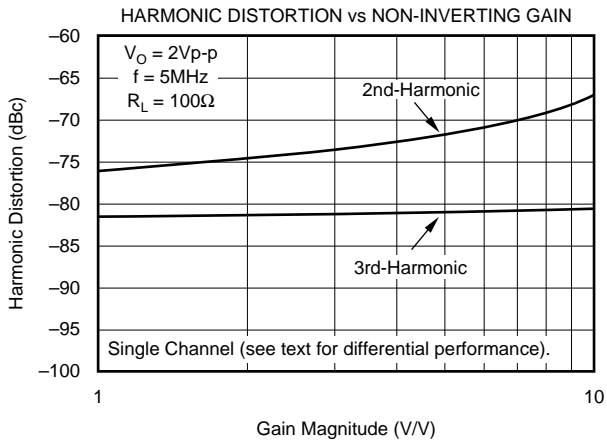
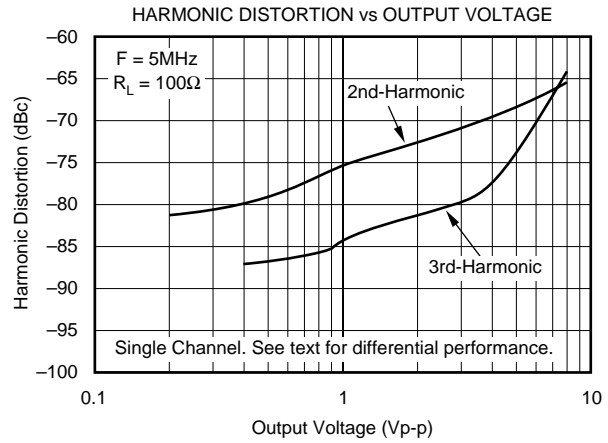
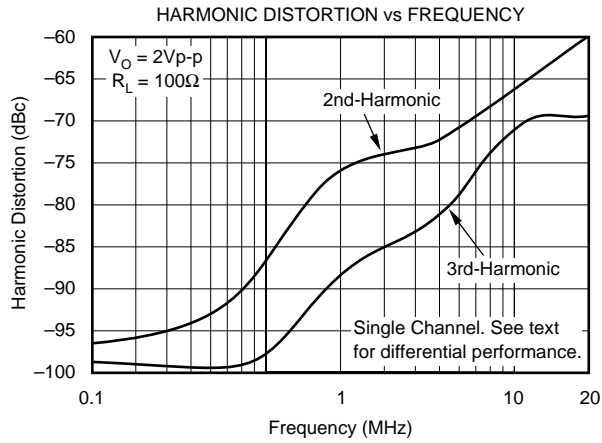

TYPICAL PERFORMANCE CURVES: $V_S = \pm 6V$ (Cont.)

At $T_A = +25^\circ C$, $G = +4$, $R_F = 402\Omega$, and $R_L = 100\Omega$, unless otherwise noted. See Figure 1 for AC performance only

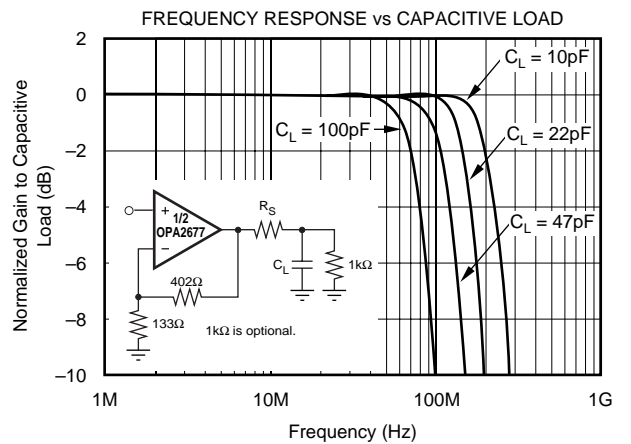
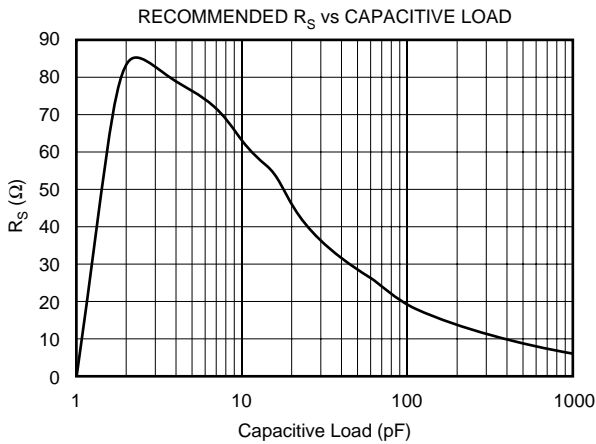
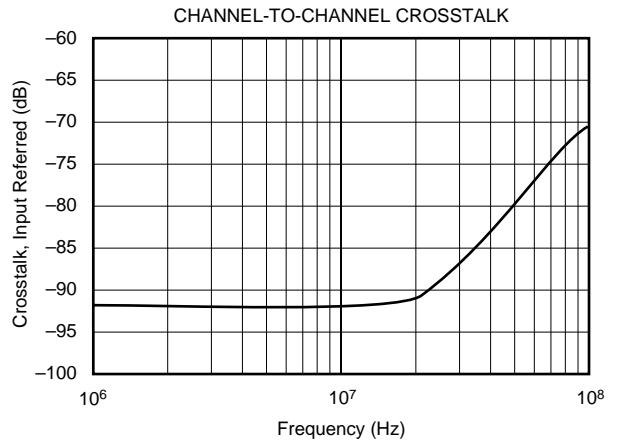
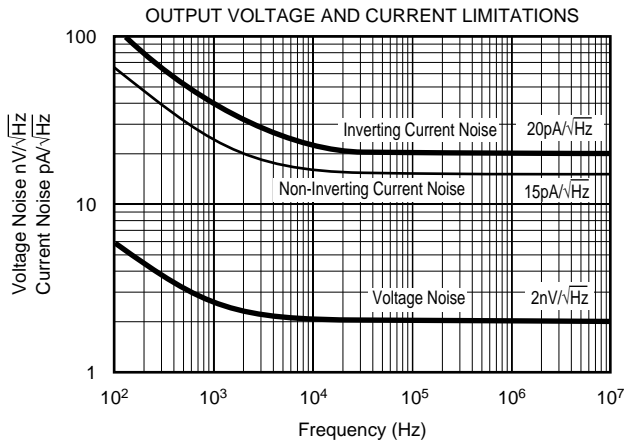
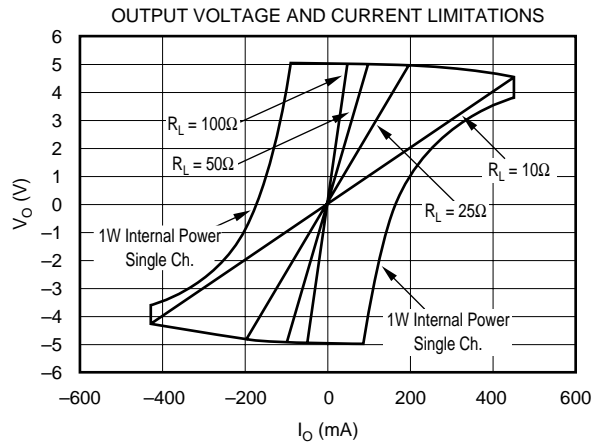
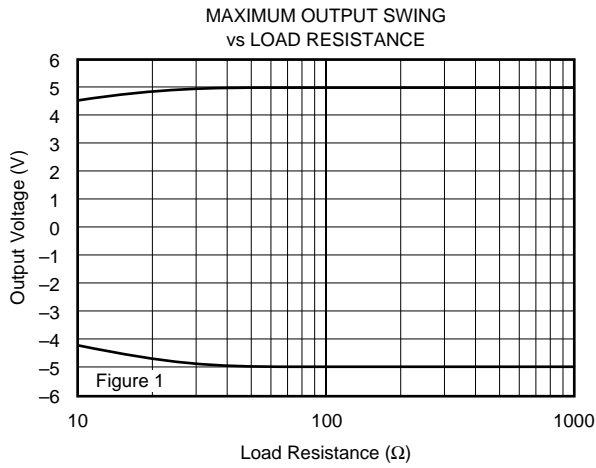

TYPICAL PERFORMANCE CURVES: $V_S = \pm 6V$ (Cont.)

At $T_A = +25^\circ C$, $G = +4$, $R_F = 402\Omega$, and $R_L = 100\Omega$, unless otherwise noted. See Figure 1 for AC performance only

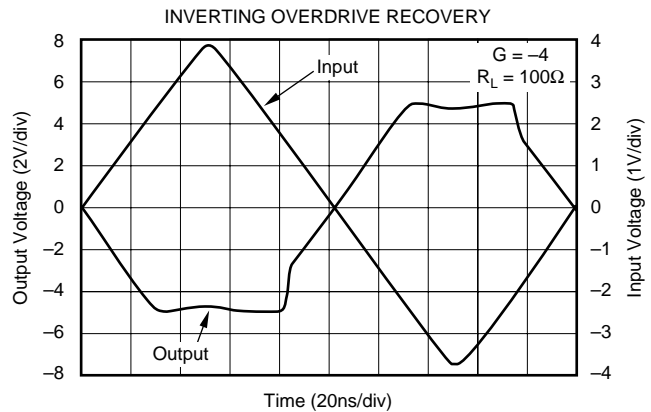
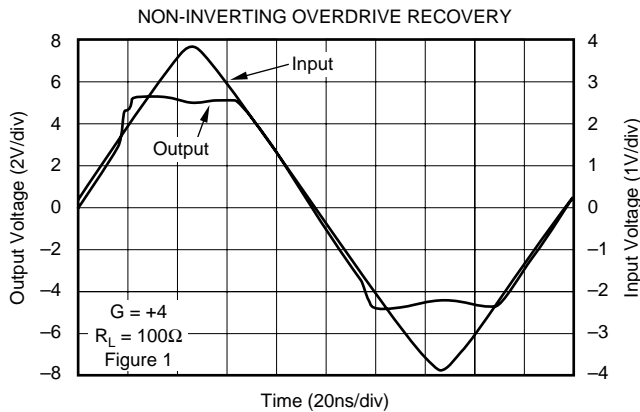
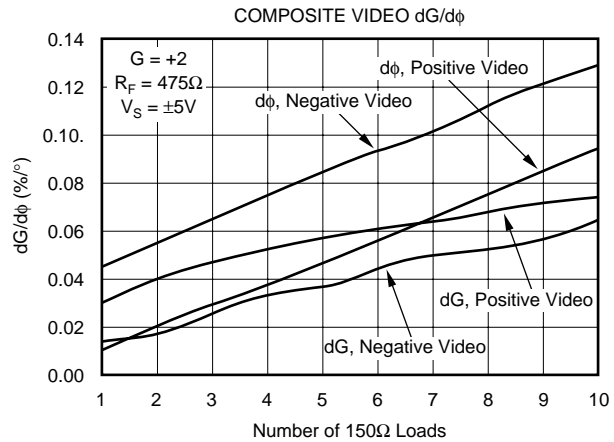
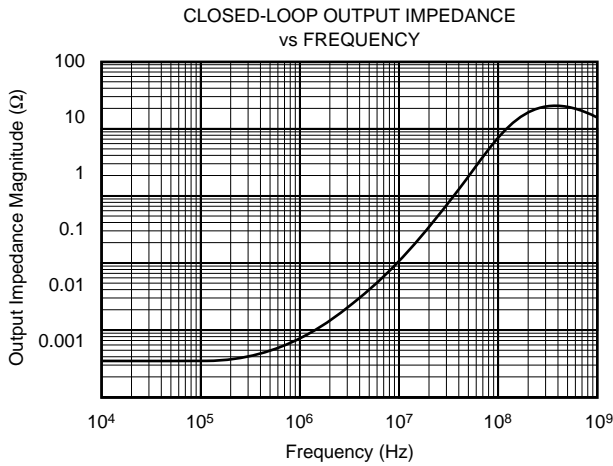
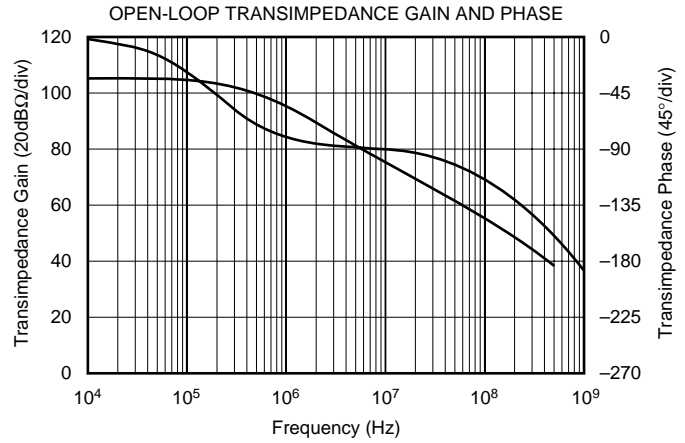
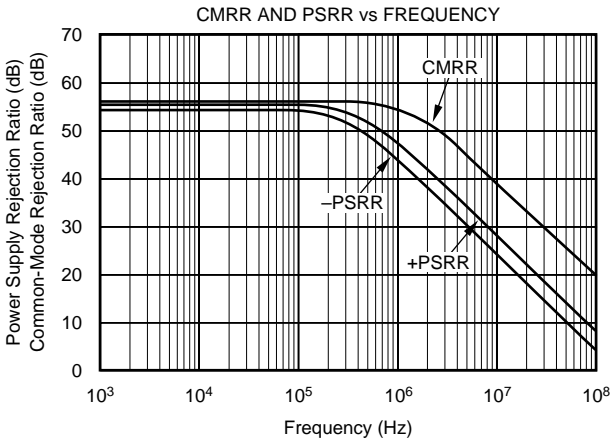

TYPICAL PERFORMANCE CURVES: $V_S = \pm 6V$ (Cont.)

At $T_A = +25^\circ C$, $G = +4$, $R_F = 402\Omega$, and $R_L = 100\Omega$, unless otherwise noted. See Figure 1 for AC performance only

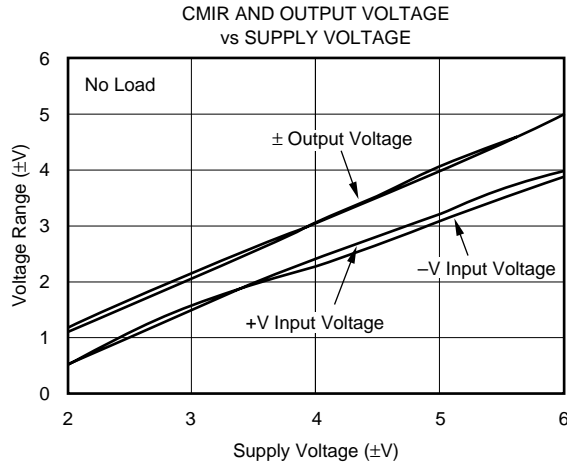
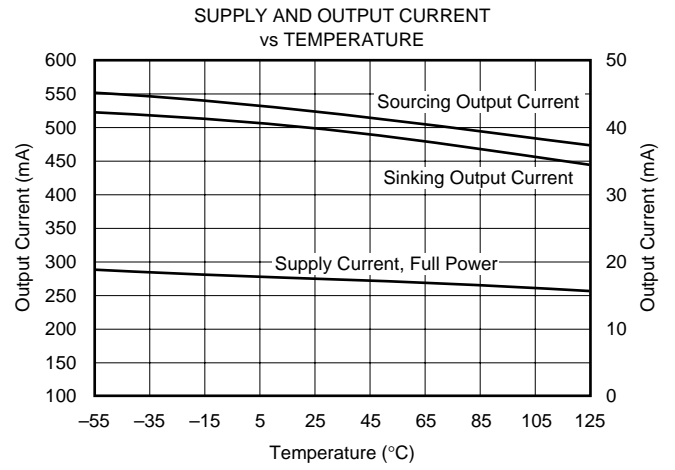
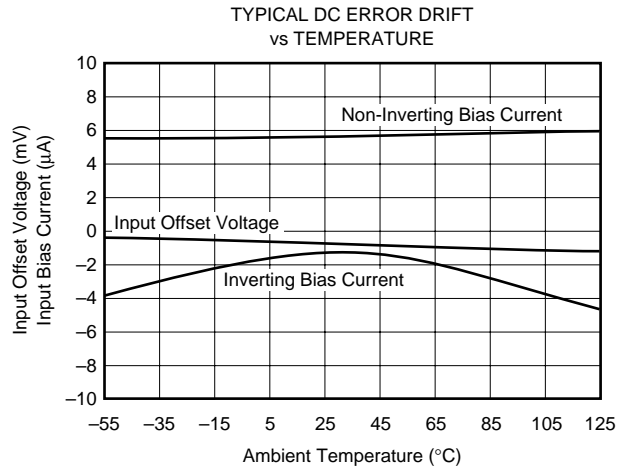

TYPICAL PERFORMANCE CURVES: $V_S = +5V$

At $T_A = +25^\circ C$, $G = +4$, $R_F = 453\Omega$, and $R_L = 100\Omega$ to $V_S/2$, unless otherwise noted. See Figure 2.

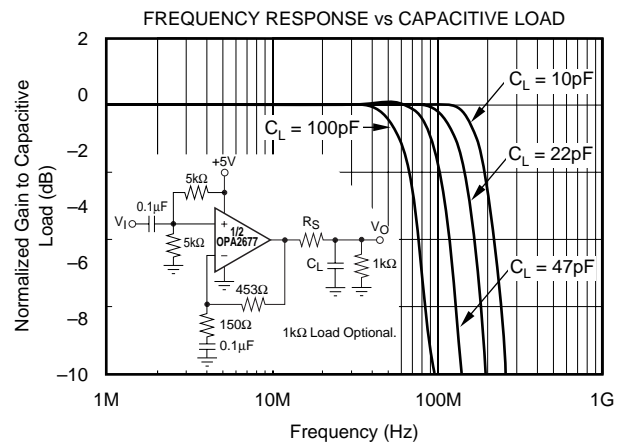
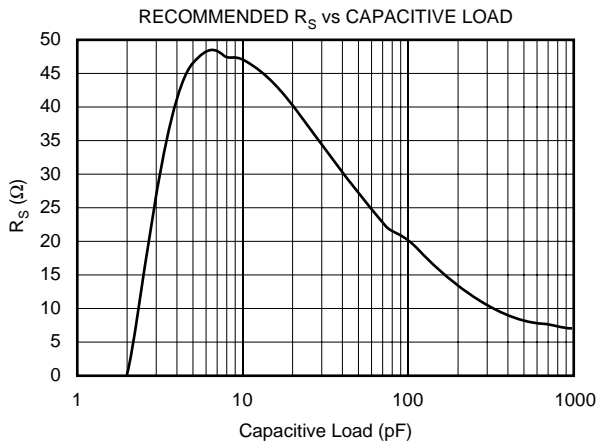
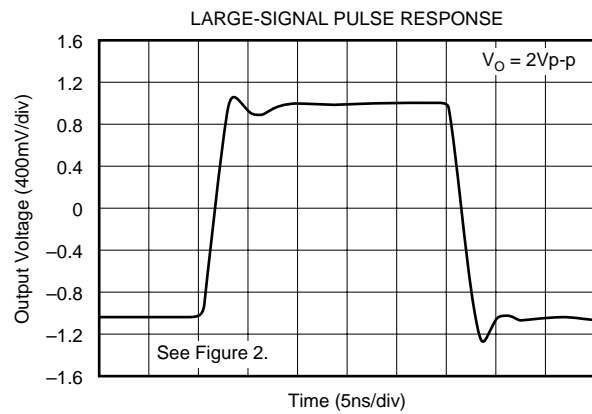
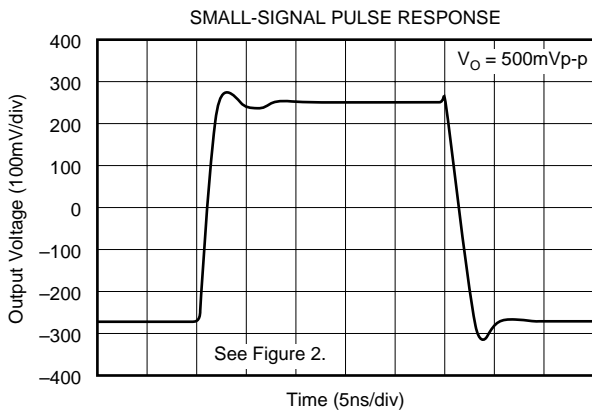
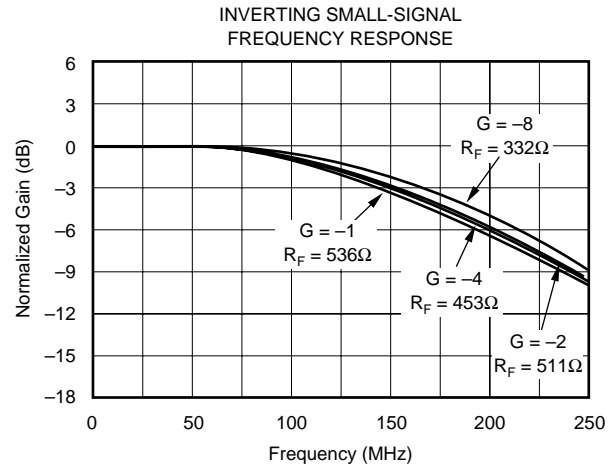
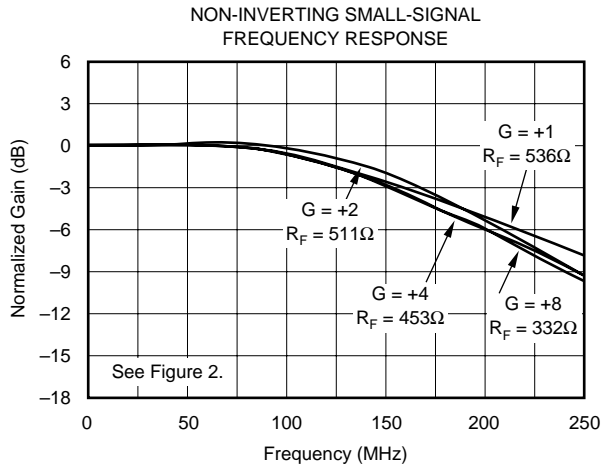

TYPICAL PERFORMANCE CURVES: $V_S = +5V$ (Cont.)

At $T_A = +25^\circ C$, $G = +4$, $R_F = 453\Omega$, and $R_L = 100\Omega$, unless otherwise noted. See Figure 2 for AC performance only.

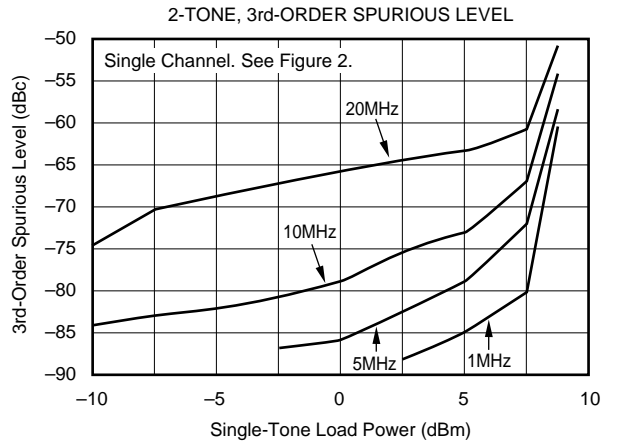
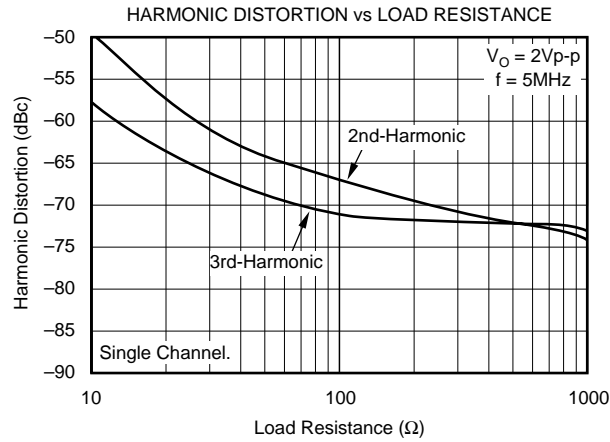
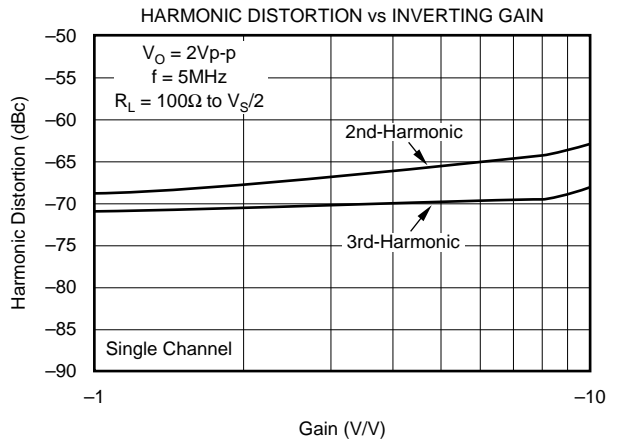
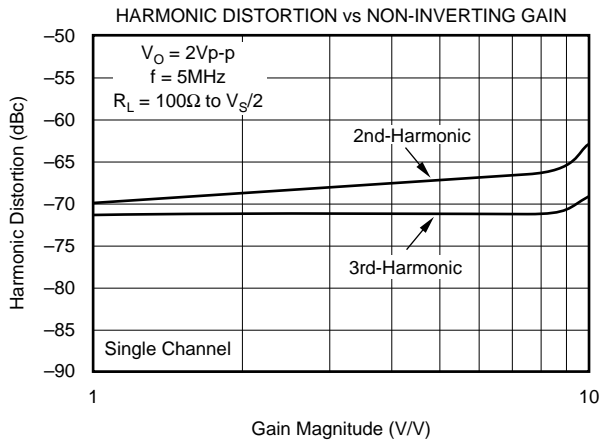
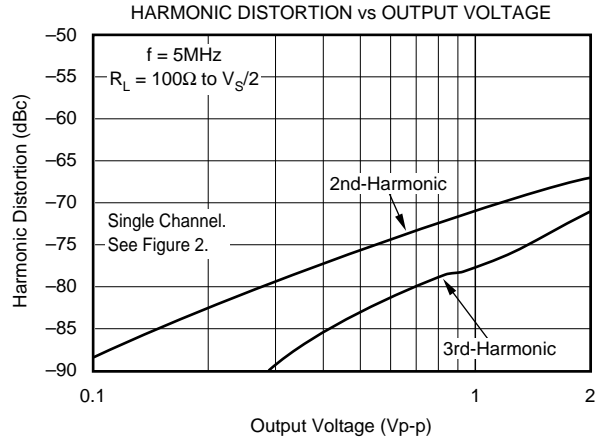
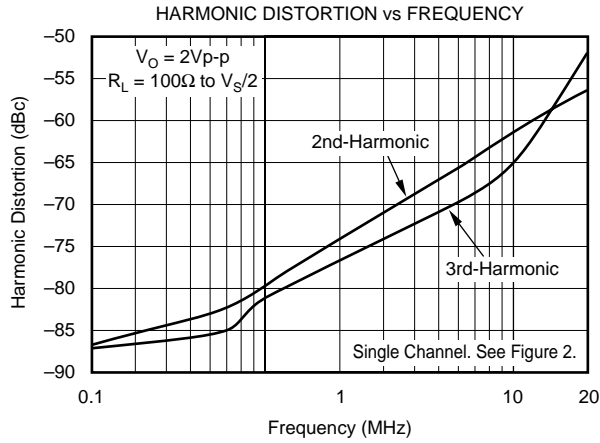

APPLICATIONS INFORMATION

WIDEBAND CURRENT FEEDBACK OPERATION

The OPA2677 gives the exceptional AC performance of a wideband current feedback op amp with a highly linear, high power output stage. Requiring only 9mA/ch. quiescent current, the OPA2677 will swing to within 1V of either supply rail and deliver in excess of 380mA guaranteed at room temperature. This low output headroom requirement, along with supply voltage independent biasing, gives remarkable single (+5V) supply operation. The OPA2677 will deliver greater than 150MHz bandwidth driving a 2Vp-p output into 100Ω on a single +5V supply. Previous boosted output stage amplifiers have typically suffered from very poor crossover distortion as the output current goes through zero. The OPA2677 achieves a comparable power gain with much better linearity. The primary advantage of a current feedback op amp over a voltage feedback op amp is that AC performance (bandwidth and distortion) is relatively independent of signal gain.

Figure 1 shows the DC coupled, gain of +4, dual power supply circuit configuration used as the basis of the ±6V Specifications and Typical Performance Curves. For test purposes, the input impedance is set to 50Ω with a resistor to ground and the output impedance is set to 50Ω with a series output resistor. Voltage swings reported in the specifications are taken directly at the input and output pins while load powers (dBm) are defined at a matched 50Ω load. For the circuit of Figure 1, the total effective load will be $100\Omega \parallel 537\Omega = 84\Omega$.

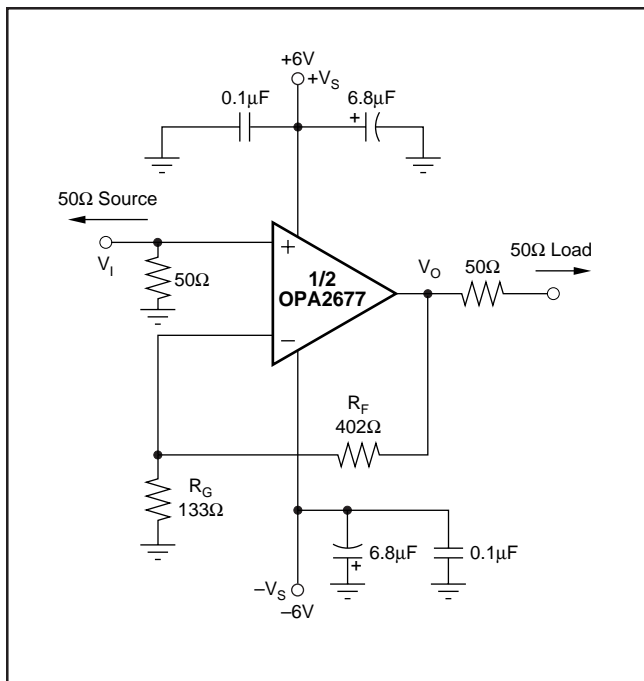

FIGURE 1. DC-Coupled, $G = +4$, Bipolar Supply, Specification and Test Circuit.

Figure 2 shows the AC coupled, gain of +4, single supply circuit configuration used as the basis of the +5V Specifications and Typical Performance Curves. Though not a “rail-to-rail” design, the OPA2677 requires minimal input and output voltage headroom compared to other very wideband current feedback op amps. It will deliver a 3Vp-p output swing on a single +5V supply with greater than 100MHz bandwidth. The key requirement of broadband single supply operation is to maintain input and output signal swings within the usable voltage ranges at both the input and the output. The circuit of Figure 2 establishes an input midpoint bias using a simple resistive divider from the +5V supply (two 806Ω resistors). The input signal is then AC coupled into this midpoint voltage bias. The input voltage can swing to within 1.3V of either supply pin, giving a 2.4Vp-p input signal range centered between the supply pins. The input impedance matching resistor (57.6Ω) used for testing is adjusted to give a 50Ω input match when the parallel combination of the biasing divider network is included. The gain resistor (R_G) is AC coupled, giving the circuit a DC gain of +1—which puts the input DC bias voltage (2.5V) on the output as well. The feedback resistor value has been adjusted from the bipolar supply condition to re-optimize for a flat frequency response in +5V, gain of +4, operation. Again, on a single +5V supply, the output voltage can swing to within 1V of either supply pin while delivering more than 200mA output current. A demanding 100Ω load to a midpoint bias is used in this characterization circuit. The new output stage used in the OPA2677 can deliver large bipolar output currents into this midpoint load with minimal crossover distortion, as shown by the +5V supply, harmonic distortion plots.

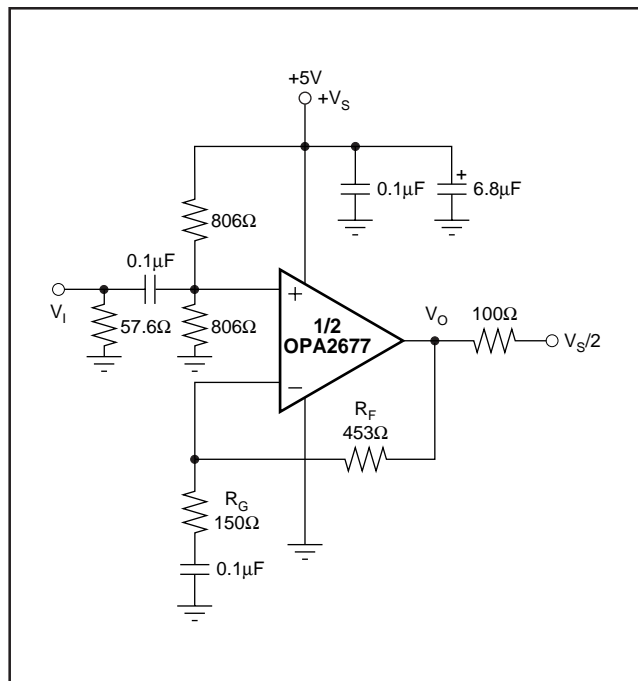

FIGURE 2. AC-Coupled, $G = +4$, Single Supply Specification and Test Circuit.

PACKAGING INFORMATION

ORDERABLE DEVICE	STATUS(1)	PACKAGE TYPE	PACKAGE DRAWING	PINS	PACKAGE QTY
OPA2677H	ACTIVE	HSOP	DTJ	8	100
OPA2677H/2K5	ACTIVE	HSOP	DTJ	8	2500
OPA2677T	ACTIVE	SOIC	D	16	48
OPA2677T/2K5	ACTIVE	SOIC	D	16	2500
OPA2677U	ACTIVE	SOIC	D	8	100
OPA2677U/2K5	ACTIVE	SOIC	D	8	2500

(1) The marketing status values are defined as follows:

ACTIVE: Product device recommended for new designs.

LIFEBUY: TI has announced that the device will be discontinued, and a lifetime-buy period is in effect.

NRND: Not recommended for new designs. Device is in production to support existing customers, but TI does not recommend using this part in a new design.

PREVIEW: Device has been announced but is not in production. Samples may or may not be available.

OBSOLETE: TI has discontinued the production of the device.

IMPORTANT NOTICE

Texas Instruments Incorporated and its subsidiaries (TI) reserve the right to make corrections, modifications, enhancements, improvements, and other changes to its products and services at any time and to discontinue any product or service without notice. Customers should obtain the latest relevant information before placing orders and should verify that such information is current and complete. All products are sold subject to TI's terms and conditions of sale supplied at the time of order acknowledgment.

TI warrants performance of its hardware products to the specifications applicable at the time of sale in accordance with TI's standard warranty. Testing and other quality control techniques are used to the extent TI deems necessary to support this warranty. Except where mandated by government requirements, testing of all parameters of each product is not necessarily performed.

TI assumes no liability for applications assistance or customer product design. Customers are responsible for their products and applications using TI components. To minimize the risks associated with customer products and applications, customers should provide adequate design and operating safeguards.

TI does not warrant or represent that any license, either express or implied, is granted under any TI patent right, copyright, mask work right, or other TI intellectual property right relating to any combination, machine, or process in which TI products or services are used. Information published by TI regarding third-party products or services does not constitute a license from TI to use such products or services or a warranty or endorsement thereof. Use of such information may require a license from a third party under the patents or other intellectual property of the third party, or a license from TI under the patents or other intellectual property of TI.

Reproduction of information in TI data books or data sheets is permissible only if reproduction is without alteration and is accompanied by all associated warranties, conditions, limitations, and notices. Reproduction of this information with alteration is an unfair and deceptive business practice. TI is not responsible or liable for such altered documentation.

Resale of TI products or services with statements different from or beyond the parameters stated by TI for that product or service voids all express and any implied warranties for the associated TI product or service and is an unfair and deceptive business practice. TI is not responsible or liable for any such statements.

Following are URLs where you can obtain information on other Texas Instruments products and application solutions:

Products		Applications	
Amplifiers	amplifier.ti.com	Audio	www.ti.com/audio
Data Converters	dataconverter.ti.com	Automotive	www.ti.com/automotive
DSP	dsp.ti.com	Broadband	www.ti.com/broadband
Interface	interface.ti.com	Digital Control	www.ti.com/digitalcontrol
Logic	logic.ti.com	Military	www.ti.com/military
Power Mgmt	power.ti.com	Optical Networking	www.ti.com/opticalnetwork
Microcontrollers	microcontroller.ti.com	Security	www.ti.com/security
		Telephony	www.ti.com/telephony
		Video & Imaging	www.ti.com/video
		Wireless	www.ti.com/wireless

Mailing Address: Texas Instruments
Post Office Box 655303 Dallas, Texas 75265

Copyright © 2003, Texas Instruments Incorporated