

E222871

Miniature Pushbutton

Specifications

Electrical Ratings	3A @ 120VAC, 28VDC 1A @ 250VAC See Contact Options	Dielectric Strength	1500Vrms min
Electrical Life	50,000 cycles typical	Insulation Resistance	>100MΩ min
Contact Resistance	<20mΩ initial @ 2-4VDC, 100mA	Operating Temperature	-40°C to 85°C
Actuator Travel	0.85mm ± 0.2mm	Storage Temperature	-40°C to 85°C

Materials

Actuator	6/6 Nylon, Glass Filled
Housing	Diallyl Phthalate (DAP)
Cover	Stainless Steel
Bushing	Brass, Nickel Plated
Contacts	Brass, Silver Plated
Terminals	Brass, Silver Plated

Ordering Information

1. Series	ANP	2	1	F4	C	Q	E	C742
ANP								
2. Number of Poles								
1 = SPDT								
2 = DPDT								
3. Switch Function								
1 = ON - (ON)								
2 = ON - ON Latching								
4. Bushing								
F4 / N4 = ¼-40NS / Non-threaded, keyway, 6.35mm								
F9 / N9 = ¼-40NS / Non-threaded, flat, 6.35mm								
**No bushing is selected is a panel mount frame is selected below								
5. Terminals								
B = Solder Lug								
C = PC pin								
D = Quick connect								
H = Horizontal mount, right angle PC pin; HS = Snap In								
V = Vertical mount, right angle PC pin								
S20 = PC pin with support bracket; V20 = Snap in support bracket *not available with SPDT								
S25 = PC pin with support bracket; V25 = Snap in support bracket								
S40 = PC pin with support bracket; V40 = Snap in support bracket								
6. Contacts								
Q = Silver plated								
R = Gold plated								
G = Gold over Silver plated								
7. Epoxy Seal								
E = Epoxy Seal								
8. Actuator Cap / Frame								
Blank = None								
C73								F75 = Snap in panel mount with frame <i>only available with momentary option</i>
C74								F76 = Snap in panel mount with frame <i>only available with momentary option</i>
C75								
C76								
C77								

Miniature Pushbutton

Switch Function



SPDT



Function	Pushbutton Position	
1	ON	(ON)
2	ON	ON
Terminals	1-3	1-2

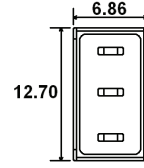
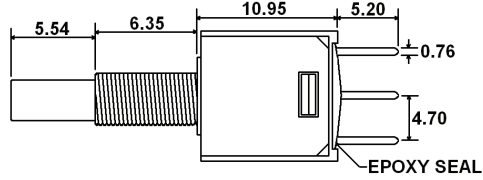
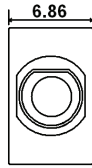

DPDT

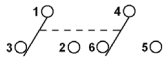

Function	Pushbutton Position	
1	ON	(ON)
2	ON	ON
Terminals	1-3 4-6	1-2 4-5

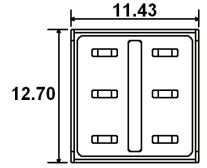
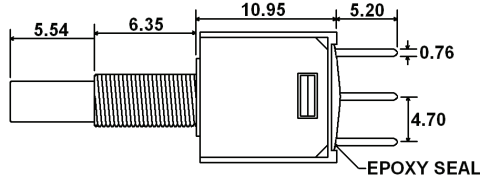
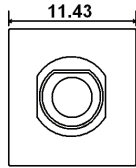

Bushing Options

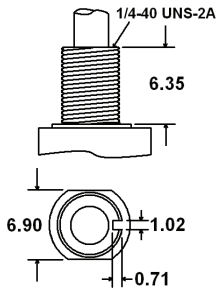

**F4 Threaded
N4 Non-Threaded**

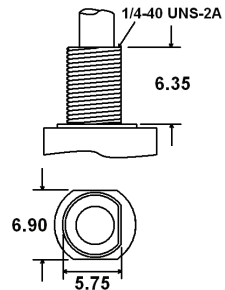

**F9 Threaded
N9 Non-Threaded**

Panel Mounting

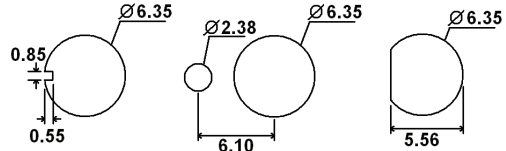

1/4" - 40 Bushing

Terminal Options

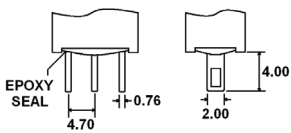

B Single Pole

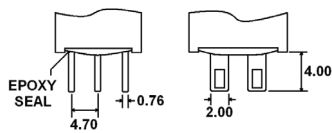

B Double Pole

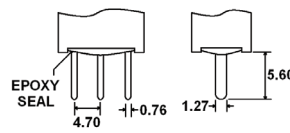

C Single Pole

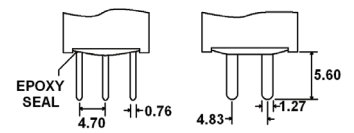

C Double Pole

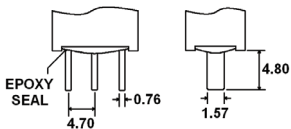

D Single Pole

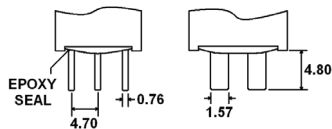

D Double Pole

Terminal Options

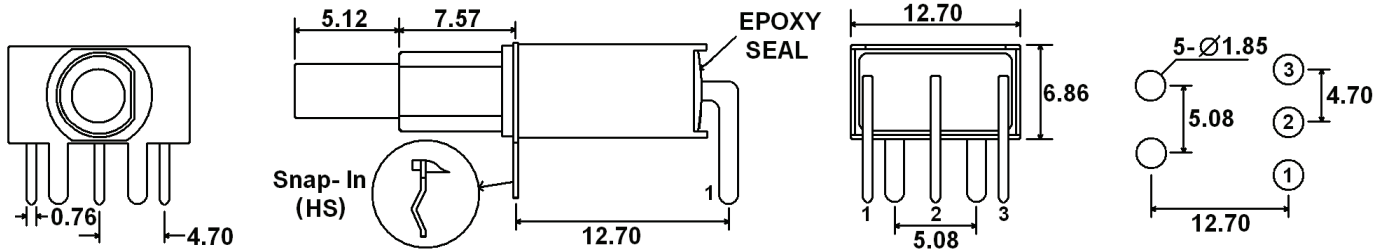

H (HS - Snap In) = Horizontal mount, right angle PC pins, single pole

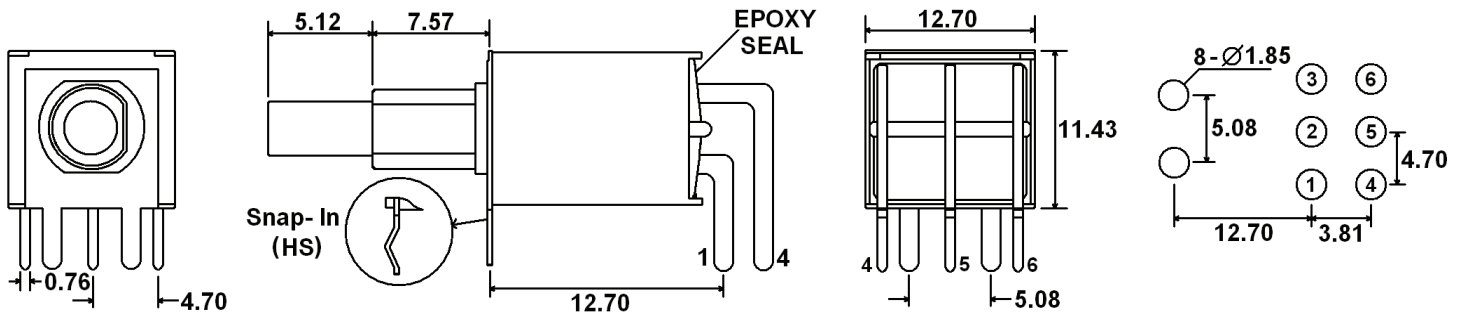

H (HS - Snap In) = Horizontal mount, right angle PC pins, double pole

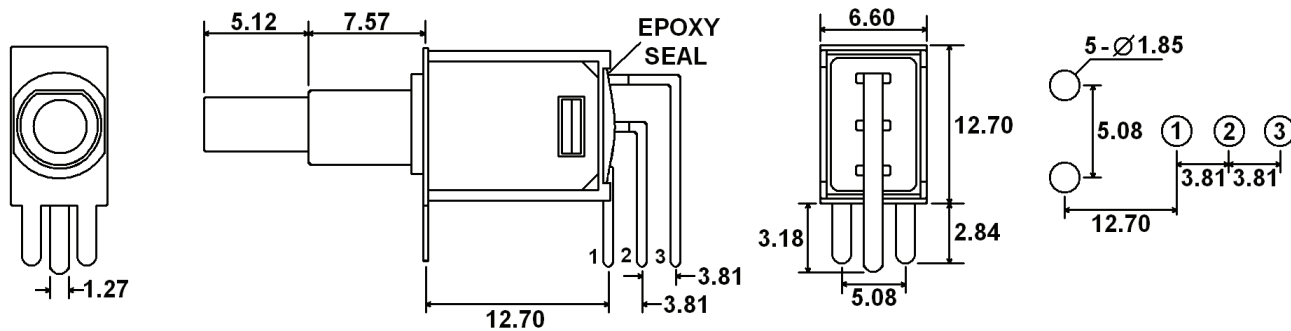

V = Vertical mount, right angle PC pins, single pole

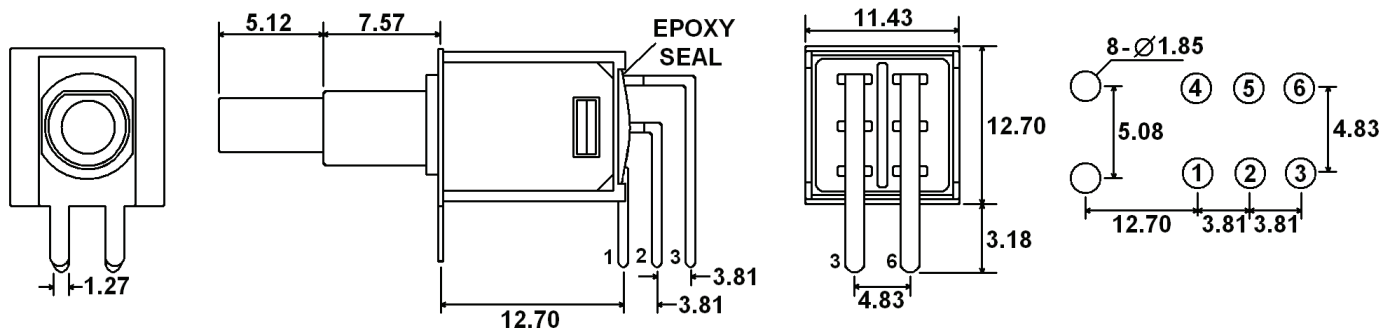

V = Vertical mount, right angle PC pins, double pole

Terminal Options

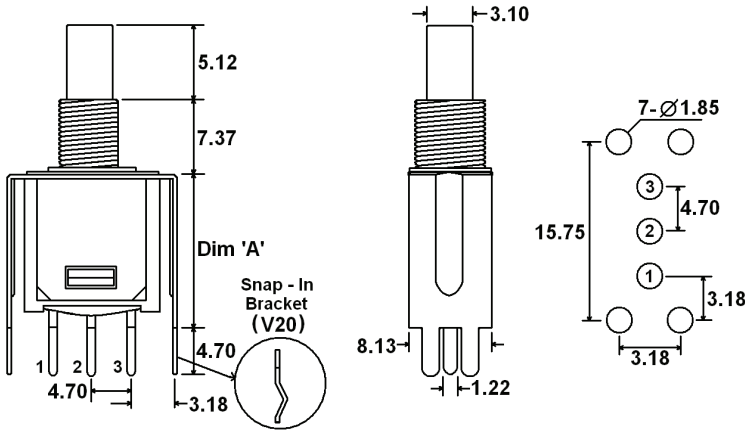

Terminal Option	"A" Dimension
S25 / V25	16.00

S25 (V25 - Snap in bracket) = PC pins with support bracket, single pole

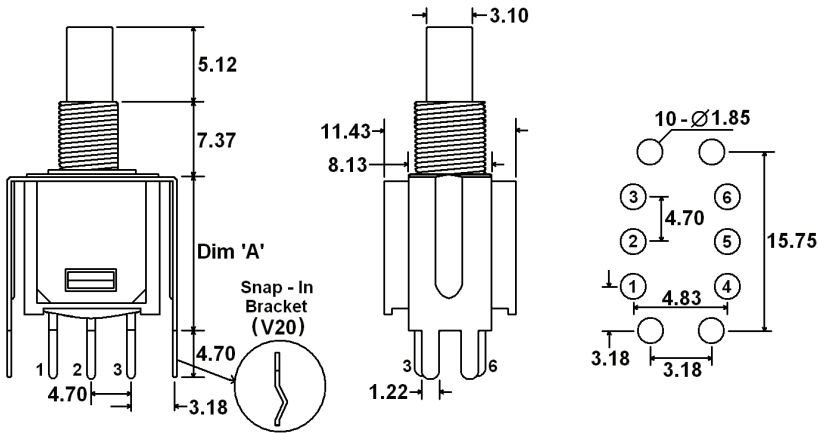

Terminal Option	"A" Dimension
S20 / V20	11.68
S25 / V25	16.00

S20 / S25 (V20/V25 - Snap in bracket) = PC pins with support bracket, double pole

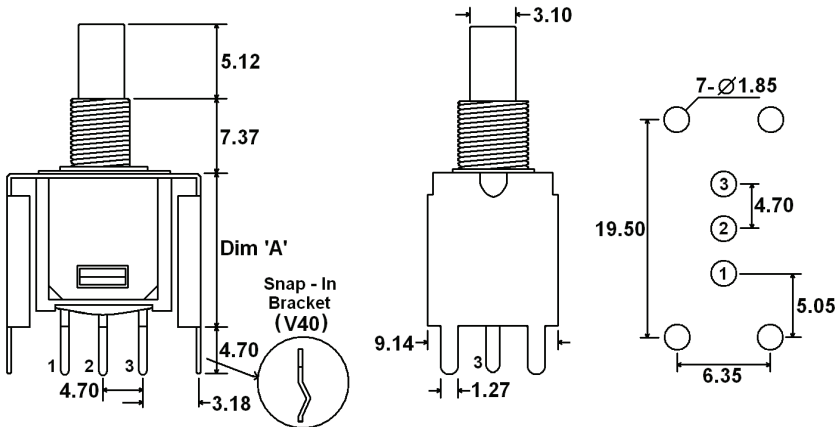

Terminal Option	"A" Dimension
S40 / V40	16.00

S40 (V40 - Snap in bracket) = PC pins with support bracket, single pole

Terminal Options

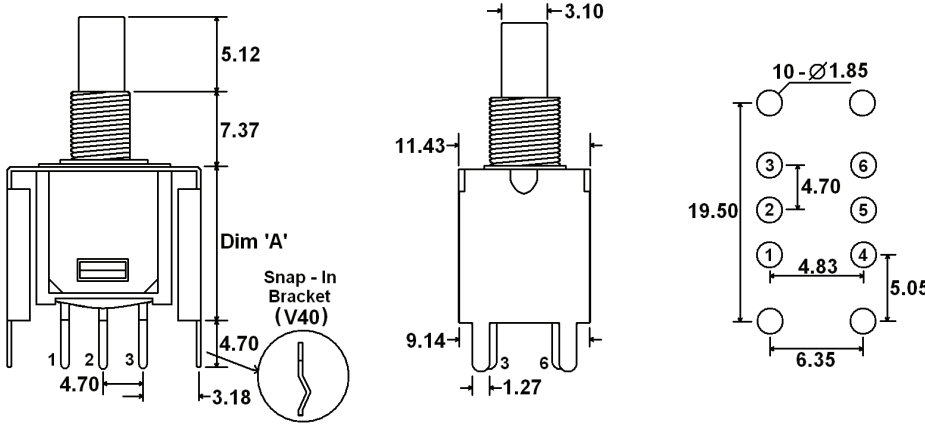

Terminal Option	"A" Dimension
S40 / V40	16.00

S40 (V40 - Snap in bracket) = PC pins with support bracket, double pole

Contact Options

Designator	Contact Material	Terminal Material	Electrical Ratings
Q	Silver Plating	Silver Plating	3A @ 120VAC, 28VDC; 1A @ 250VAC
R	Gold over Nickel Plating	Gold over Nickel Plating	0.4VA max @ 20VAC or VDC max
G	Gold over Silver Plating	Gold over Silver Plating	0.4VA max @ 20VAC or VDC max or 3A @ 120VAC, 28VDC; 1A @ 250VAC

Cap Options

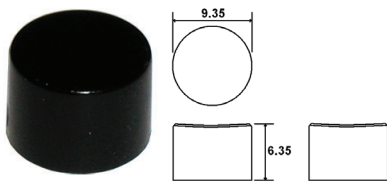

C73_

1 = White, 2 = Black, 3 = Red
Contact Factory for other available colors

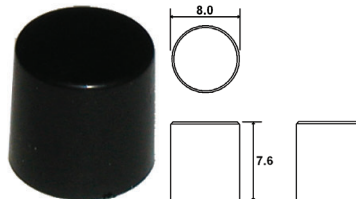

C74_

1 = White, 2 = Black, 3 = Red
Contact Factory for other available colors

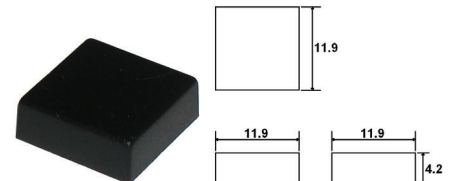

C75_

1 = White, 2 = Black, 3 = Red
Contact Factory for other available colors

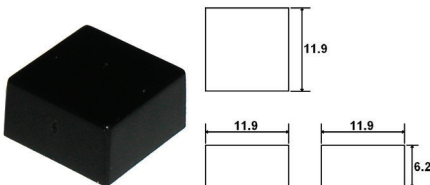

C76_

1 = White, 2 = Black, 3 = Red, 9
Contact Factory for other available colors

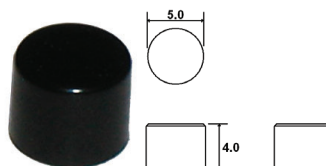

C77_

1 = White, 2 = Black, 3 = Red
Contact Factory for other available colors

Frame Options

F75__ ← Insert cap and frame colors here

Increase the length dimension to 15.75 / 15.88 for 1.5 / 3.2 thick panels

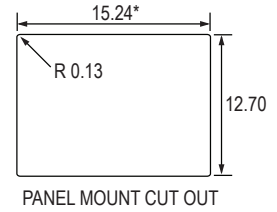
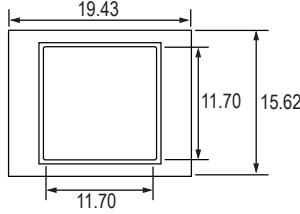
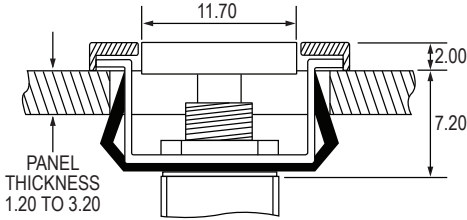

Cap Color / Frame Color
1 = White, 2 = Black, 3 = Red
Contact Factory for other available colors

F76__ ← Insert cap and frame colors here

Increase the length dimension to 15.75 / 15.88 for 1.5 / 3.2 thick panels

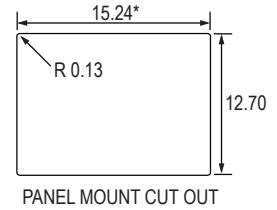
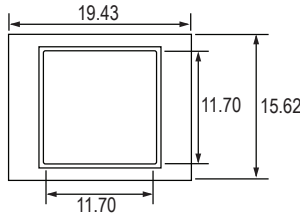
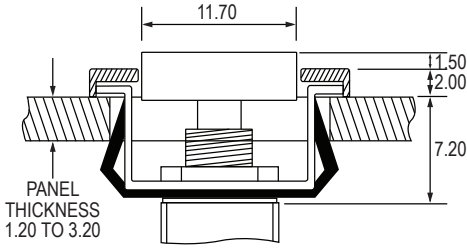

Cap Color / Frame Color
1 = White, 2 = Black, 3 = Red
Contact Factory for other available colors

Hardware

Two hex nuts, one lock washer & one locking ring supplied standard with threaded bushings

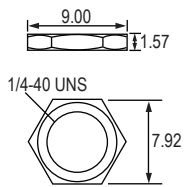

Hex Nut

For use with F4 & F9 Bushing

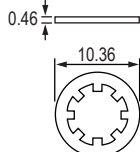

Lock Washer

For use with F4 & F9 Bushing

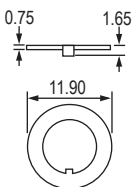

Locking Ring

For use with F4 & F9 Bushing

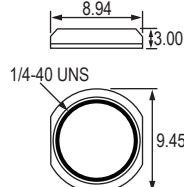

Dress Nut

For use with F4 & F9 Bushing

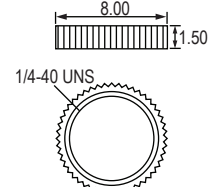

Knurled Nut

For use with F4 & F9 Bushing

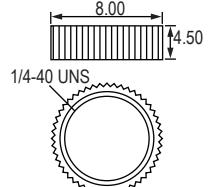

Knurled Nut

For use with F4 & F9 Bushing

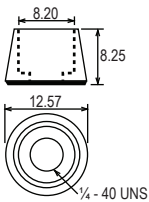

Cap Shroud A

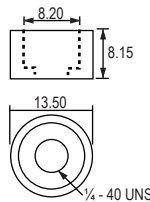

Cap Shroud B

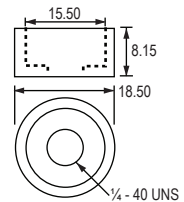

Cap Shroud C