

Low Power, Low Dropout, 500mA RF Linear Regulators

FEATURES

- Low Output Noise
- Low Dropout Voltage
- Thermal-Overload Protection
- Output Current Limit
- 10nA Logic-Controlled Shutdown
- 30µA(TYP) Low Supply Current
- 1.7V to 7.5V Input Voltage Range
- 500mA Output Current
- -40°C to +85°C Operating Temperature Range
- Available in Green UTDFN-1x1-4, SOT23-5, SOT23-3, SOT353(SC70-5) and SOT89-3L (L-Type) Package

APPLICATIONS

- Cellular Telephones
- Camera Modules
- Modems
- HiFi Audio Radio Transceivers
- PLL/Synthesizer, Clocking
- Medium-Current, Noise-Sensitive Applications

DESCRIPTION

The RS3236 series low-power, low-dropout, CMOS LDO operate from 1.7V to 7.5V input voltage that can supply up to 500mA of output current. Designed to meet the requirements of RF and analog circuits, the RS3236 series device provides low noise, high PSRR, low quiescent current, and low line and load transient response.

The device is designed to work with a 1-µF input and a 1-µF output ceramic capacitor (no separate noise bypass capacitor required). An external noise bypass capacitor connected to the device's BP pin can further reduce the noise level.

Other features include a 10nA logic-controlled shutdown mode, foldback current limit and thermal shutdown protection.

The RS3236 series is available in Green UTDFN-1x1-4, SOT23-3, SOT23-5, SOT353(SC70-5) and SOT89-3L(L-Type) package. It operates over an ambient temperature range of -40°C to +85°C.

Functional Block Diagram

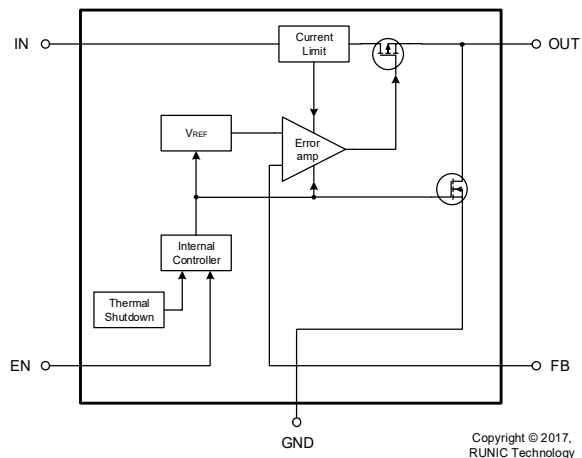
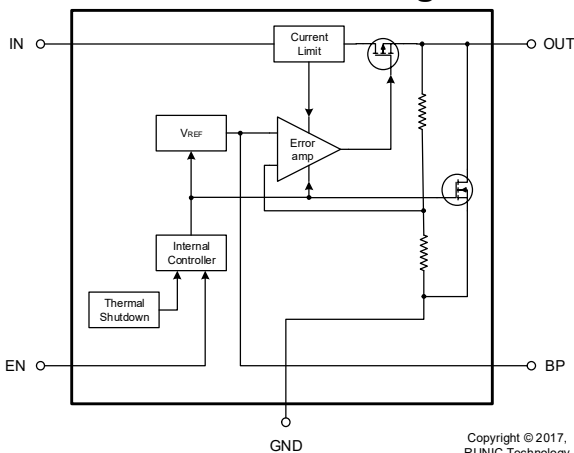

Pin Configuration and Functions (Top View)

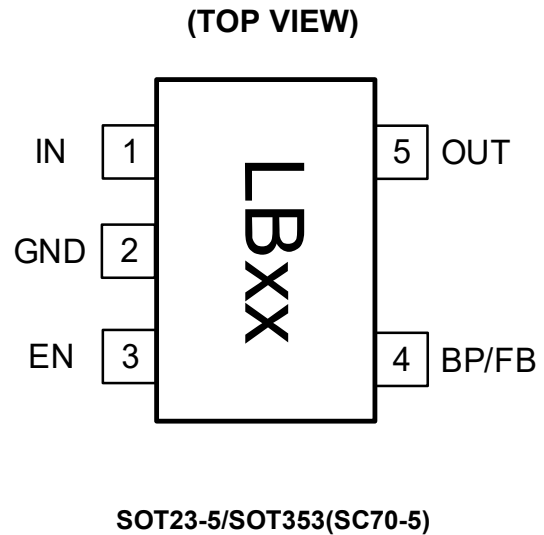
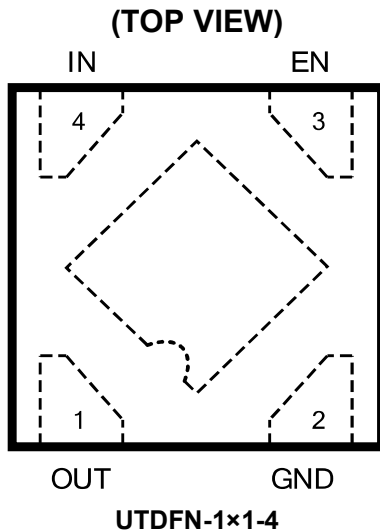

UTDFN-1×1-4		I/O	DESCRIPTION
NUMBER	NAME		
1	OUT	O	Regulator Output.
2	GND	G	Ground.
3	EN	I	Enable Input. A logic low reduces the supply current to 10nA. Connect to IN for normal operation.
4	IN	I	Regulator Input. Supply voltage can range from 1.7V to 7.5V. Bypass with a 1μF capacitor to GND.
Thermal Pad	-	-	Connect the thermal pad to a large-area ground plane. This pad is not an electrical connection to the device ground.

SOT23-5 /SOT353(SC70-5)		I/O	DESCRIPTION
NUMBER	NAME		
1	IN	I	Regulator Input. Supply voltage can range from 1.7V to 7.5V. Bypass with a 1μF capacitor to GND.
2	GND	G	Ground.
3	EN	I	Enable Input. A logic low reduces the supply current to 10nA. Connect to IN for normal operation.
4	BP/NC	O	NC or connect 0.01uF ceramic capacitor for reduced noise at the output.
	FB		Feedback Pin (adjustable voltage version only). This is used to set the output voltage of the device.
5	OUT	O	Regulator Output.

Pin Configuration and Functions (Top View)

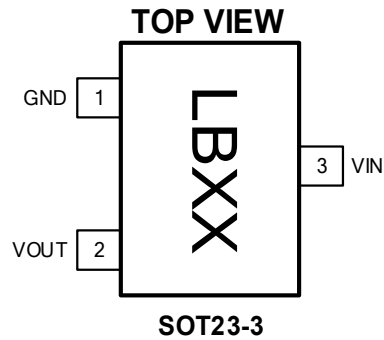

NOTE: XX indicate Output Voltage, xx indicate DataCode
 For example: LB33 ($V_{OUT}=3.3V$)

SOT23-3		I/O	DESCRIPTION
NUMBER	NAME		
1	GND	G	Ground.
2	OUT	O	Regulator Output.
3	IN	I	Regulator Input. Supply voltage can range from 1.7V to 7.5V. Bypass with a 1 μ F capacitor to GND.

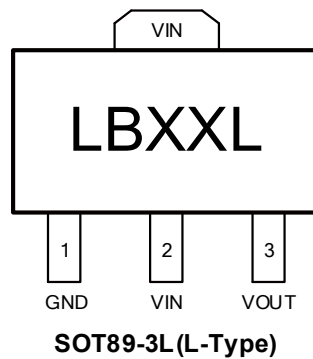

SOT89-3L(L-Type)		I/O	DESCRIPTION
NUMBER	NAME		
1	GND	G	Ground.
2	IN	I	Regulator Input. Supply voltage can range from 1.7V to 7.5V. Bypass with a 1 μ F capacitor to GND.
3	OUT	O	Regulator Output.

PACKAGE/ORDERING INFORMATION

PRODUCT	ORDERING NUMBER ⁽²⁾	V _{out} (V)	V _{out} Accuracy	PACKAGE LEAD	PACKAGE MARKING ⁽¹⁾	PACKAGE OPTION
RS3236-0.75	RS3236-0.75YUTDN4	0.75V	±2.5%	UTDFN-1x1-4	BA	Tape and Reel,10000
	RS3236-0.75YF5	0.75V	±2.5%	SOT23-5	LB075	Tape and Reel,3000
	RS3236-0.75YC5	0.75V	±2.5%	SOT353(SC70-5)	LB075	Tape and Reel,3000
	RS3236-0.75YF3	0.75V	±2.5%	SOT23-3	LB075	Tape and Reel,3000
RS3236-1.0	RS3236-1.0YUTDN4	1.0V	±2.5%	UTDFN-1x1-4	BB	Tape and Reel,10000
	RS3236-1.0YF5	1.0V	±2.5%	SOT23-5	LB10	Tape and Reel,3000
	RS3236-1.0YC5	1.0V	±2.5%	SOT353(SC70-5)	LB10	Tape and Reel,3000
	RS3236-1.0YF3	1.0V	±2.5%	SOT23-3	LB10	Tape and Reel,3000
RS3236-1.2	RS3236-1.2YUTDN4	1.2V	±2.5%	UTDFN-1x1-4	BC	Tape and Reel,10000
	RS3236-1.2YF5	1.2V	±2.5%	SOT23-5	LB12	Tape and Reel,3000
	RS3236-1.2YC5	1.2V	±2.5%	SOT353(SC70-5)	LB12	Tape and Reel,3000
	RS3236-1.2YF3	1.2V	±2.5%	SOT23-3	LB12	Tape and Reel,3000
RS3236-1.5	RS3236-1.5YUTDN4	1.5V	±2.5%	UTDFN-1x1-4	BD	Tape and Reel,10000
	RS3236-1.5YF5	1.5V	±2.5%	SOT23-5	LB15	Tape and Reel,3000
	RS3236-1.5YC5	1.5V	±2.5%	SOT353(SC70-5)	LB15	Tape and Reel,3000
	RS3236-1.5YF3	1.5V	±2.5%	SOT23-3	LB15	Tape and Reel,3000
RS3236-1.8	RS3236-1.8YUTDN4	1.8V	±2.5%	UTDFN-1x1-4	BE	Tape and Reel,10000
	RS3236-1.8YF5	1.8V	±2.5%	SOT23-5	LB18	Tape and Reel,3000
	RS3236-1.8YC5	1.8V	±2.5%	SOT353(SC70-5)	LB18	Tape and Reel,3000
	RS3236-1.8YF3	1.8V	±2.5%	SOT23-3	LB18	Tape and Reel,3000
	RS3236-1.8YE3L	1.8V	±2.5%	SOT89-3L(L-Type)	LB18L	Tape and Reel,1000
RS3236-2.05	RS3236-2.05YUTDN4	2.05V	±2.5%	UTDFN-1x1-4	BF	Tape and Reel,10000
	RS3236-2.05YF5	2.05V	±2.5%	SOT23-5	LB205	Tape and Reel,3000
	RS3236-2.05YC5	2.05V	±2.5%	SOT353(SC70-5)	LB205	Tape and Reel,3000
	RS3236-2.05YF3	2.05V	±2.5%	SOT23-3	LB205	Tape and Reel,3000
RS3236-2.5	RS3236-2.5YUTDN4	2.5V	±2.5%	UTDFN-1x1-4	BG	Tape and Reel,10000
	RS3236-2.5YF5	2.5V	±2.5%	SOT23-5	LB25	Tape and Reel,3000
	RS3236-2.5YC5	2.5V	±2.5%	SOT353(SC70-5)	LB25	Tape and Reel,3000
	RS3236-2.5YF3	2.5V	±2.5%	SOT23-3	LB25	Tape and Reel,3000
RS3236-2.8	RS3236-2.8YUTDN4	2.8V	±2.5%	UTDFN-1x1-4	BH	Tape and Reel,10000
	RS3236-2.8YF5	2.8V	±2.5%	SOT23-5	LB28	Tape and Reel,3000
	RS3236-2.8YC5	2.8V	±2.5%	SOT353(SC70-5)	LB28	Tape and Reel,3000
	RS3236-2.8YF3	2.8V	±2.5%	SOT23-3	LB28	Tape and Reel,3000
RS3236-3.0	RS3236-3.0YUTDN4	3.0V	±2.5%	UTDFN-1x1-4	BI	Tape and Reel,10000
	RS3236-3.0YF5	3.0V	±2.5%	SOT23-5	LB30	Tape and Reel,3000
	RS3236-3.0YC5	3.0V	±2.5%	SOT353(SC70-5)	LB30	Tape and Reel,3000
	RS3236-3.0YF3	3.0V	±2.5%	SOT23-3	LB30	Tape and Reel,3000
RS3236-3.3	RS3236-3.3YUTDN4	3.3V	±2.5%	UTDFN-1x1-4	BJ	Tape and Reel,10000
	RS3236-3.3YF5	3.3V	±2.5%	SOT23-5	LB33	Tape and Reel,3000
	RS3236-3.3YC5	3.3V	±2.5%	SOT353(SC70-5)	LB33	Tape and Reel,3000
	RS3236-3.3YF3	3.3V	±2.5%	SOT23-3	LB33	Tape and Reel,3000
	RS3236-3.3YE3L	3.3V	±2.5%	SOT89-3L(L-Type)	LB33L	Tape and Reel,1000
RS3236-3.6	RS3236-3.6YUTDN4	3.6V	±2.5%	UTDFN-1x1-4	BK	Tape and Reel,10000
	RS3236-3.6YF5	3.6V	±2.5%	SOT23-5	LB36	Tape and Reel,3000
	RS3236-3.6YC5	3.6V	±2.5%	SOT353(SC70-5)	LB36	Tape and Reel,3000
	RS3236-3.6YF3	3.6V	±2.5%	SOT23-3	LB36	Tape and Reel,3000
RS3236-4.0	RS3236-4.0YUTDN4	4.0V	±2.5%	UTDFN-1x1-4	BL	Tape and Reel,10000
	RS3236-4.0YF5	4.0V	±2.5%	SOT23-5	LB40	Tape and Reel,3000
	RS3236-4.0YC5	4.0V	±2.5%	SOT353(SC70-5)	LB40	Tape and Reel,3000

	RS3236-4.0YF3	4.0V	±2.5%	SOT23-3	LB40	Tape and Reel,3000
	RS3236-4.0YE3L	4.0V	±2.5%	SOT89-3L(L-Type)	LB40L	Tape and Reel,1000
RS3236-5.0	RS3236-5.0YUTDN4	5.0V	±2.5%	UTDFN-1x1-4	BM	Tape and Reel,10000
	RS3236-5.0YF5	5.0V	±2.5%	SOT23-5	LB50	Tape and Reel,3000
	RS3236-5.0YC5	5.0V	±2.5%	SOT353(SC70-5)	LB50	Tape and Reel,3000
	RS3236-5.0YF3	5.0V	±2.5%	SOT23-3	LB50	Tape and Reel,3000
RS3236-1.35	RS3236-1.35YUTDN4	1.35V	±2.5%	UTDFN-1x1-4	BN	Tape and Reel,10000
RS3236-1.85	RS3236-1.85YUTDN4	1.85V	±2.5%	UTDFN-1x1-4	BO	Tape and Reel,10000
RS3236-2.7	RS3236-2.7YF5	2.7V	±2.5%	SOT23-5	LB27	Tape and Reel,3000
RS3236-2.1	RS3236-2.1YF5	2.1V	±2.5%	SOT23-5	LB21	Tape and Reel,3000
RS3236-2.85	RS3236-2.85YF5	2.85V	±2.5%	SOT23-5	LB285	Tape and Reel,3000

PRODUCT	ORDERING NUMBER ⁽²⁾	V _{out} (V)	V _{out} Accuracy	PACKAGE LEAD	PACKAGE MARKING ⁽¹⁾	PACKAGE OPTION
RS3236-3.3	RS3236-3.3AYUTDN4	3.3V	±1%	UTDFN-1x1-4	BJ	Tape and Reel,10000
RS3236-3.3	RS3236-3.3AYF5	3.3V	±1%	SOT23-5	LB33A	Tape and Reel, 3000
RS3236-5.0	RS3236-5.0AYF5	5.0V	±1%	SOT23-5	LB50A	Tape and Reel, 3000

MODEL	V _{FB} (V)	PIN-PACKAGE	ORDERING NUMBER	PACKAGE MARKING ⁽¹⁾	PACKAGE OPTION
RS3236-ADJ8	0.81	SOT23-5	RS3236-ADJ8YF5	LBAD8	Tape and Reel, 3000
		SOT353(SC70-5)	RS3236-ADJ8YC5	LBAD8	Tape and Reel, 3000
RS3236-ADJC	1.21	SOT23-5	RS3236-ADJCYF5	LBADC	Tape and Reel, 3000
		SOT353(SC70-5)	RS3236-ADJCYC5	LBADC	Tape and Reel, 3000

NOTE:

(1) There may be additional marking, which relates to the lot trace code information(include data code and vendor code), the logo or the environmental category on the device.

(2) RS3236-□□□□

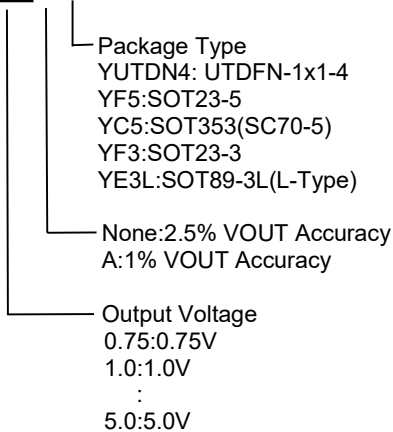

Absolute Maximum Ratings

over operating free-air temperature range (unless otherwise noted) ⁽¹⁾⁽²⁾

		MIN	MAX	UNIT
V _{IN}	Input voltage	-0.3	8	V
V _{EN}	Enable input voltage	-0.3	V _{IN}	V
T _J	Junction temperature		150	°C
P _D	Continuous power dissipation ⁽³⁾	Internally Limited		W
T _{stg}	Storage temperature	-65	150	°C

(1) Stresses beyond those listed under *Absolute Maximum Ratings* may cause permanent damage to the device. These are stress ratings only, and functional operation of the device at these or any other conditions beyond those indicated under *Recommended Operating Conditions* is not implied. Exposure to absolute-maximum-rated conditions for extended periods may affect device reliability.

(2) All voltages are with respect to the GND pin.

(3) Internal thermal shutdown circuitry protects the device from permanent damage.

ESD Ratings

		VALUE	UNIT
V _(ESD)	Electrostatic discharge	Human-body model (HBM)	±6000
		Machine model (MM)	±400

Recommended Operating Conditions

over operating free-air temperature range (unless otherwise noted) ⁽¹⁾

		MIN	MAX	UNIT
V _{IN}	Input supply voltage	1.7	7.5	V
V _{EN}	Enable input voltage	0	V _{IN}	V
I _{OUT}	Output current	0	500	mA
T _A	Operating temperature	-40	+85	°C

(1) All voltages are with respect to the GND pin.

Thermal Information

THERMAL METRIC (1)		RS3236	RS3236	RS3236	RS3236	RS3236	UNIT
		UTDFN-1x1-4	SOT353 (SC70-5)	SOT23-5	SOT23-3	SOT89-3L (L-Type)	
		4 PINS	5 PINS	5 PINS	3 PINS	3 PINS	
R _{θJA}	Junction-to-ambient thermal resistance	312.5	312.5	250	312.5	208.3	°C/W
R _{θJC(top)}	Junction-to-case (top) thermal resistance	137.9	141.8	84.3	134.3	88.5	°C/W
R _{θJB}	Junction-to-board thermal resistance	83.5	84.5	39.5	84.5	39.6	°C/W
ψ _{JT}	Junction-to-top characterization parameter	5.3	3.9	2.86	4.8	26.5	°C/W
ψ _{JB}	Junction-to-board characterization parameter	83.8	82.1	58.7	81.5	49.7	°C/W
R _{JC(bot)}	Junction-to-case (bottom) thermal resistance	71.8	N/A	N/A	N/A	77.7	°C/W
P _d	Power Dissipation	0.4	0.4	0.5	0.4	0.6	W

ELECTRICAL CHARACTERISTICS

($V_{IN} = V_{OUT(NOMINAL)} + 0.5V^{(1)}$, Full = $-40^{\circ}C$ to $+85^{\circ}C$, unless otherwise noted.)

PARAMETER	SYMBOL	CONDITIONS		TEMP	MIN	TYP	MAX	UNITS
Input Voltage	V_{IN}			$+25^{\circ}C$	1.7 ⁽¹⁾		7.5	V
Output Voltage Accuracy		$I_{OUT} = 0.1mA$		$+25^{\circ}C$	-2.5		2.5	%
		$I_{OUT} = 0.1mA$, RS3236-xxA		$+25^{\circ}C$	-1		1	%
Feedback Voltage	V_{FB}	$I_{OUT} = 0.1mA$, RS3236-ADJ8		$+25^{\circ}C$	0.79	0.81	0.83	V
		$I_{OUT} = 0.1mA$, RS3236-ADJC		$+25^{\circ}C$	1.18	1.21	1.24	V
Maximum Output Current				$+25^{\circ}C$	500			mA
Current Limit	I_{LIM}			$+25^{\circ}C$	500	800		mA
Ground Pin Current	I_Q	No load		$+25^{\circ}C$		30	40	μA
Dropout Voltage ⁽²⁾	V_{DROP}	$I_{OUT} = 500mA$	$V_{OUT}=1.2V$	$+25^{\circ}C$		900		mV
			$V_{OUT}=1.5V$			630		
			$V_{OUT}=3.3V$			450	600	
Line Regulation	ΔV_{LNR}	$V_{IN} = (V_{OUT} + 0.5V)$ to 5.5V, $I_{OUT} = 1mA$		$+25^{\circ}C$		0.1	0.2	%/V
Load Regulation	ΔV_{OUT}	$I_{OUT} = 0.1mA$ to 500mA, $C_{OUT} = 1\mu F$		$+25^{\circ}C$		25	50	mV
		$I_{OUT} = 0.1mA$ to 500mA, $C_{OUT} = 1\mu F$, RS3236-ADJ		$+25^{\circ}C$		0.5	10	mV
Output Voltage Noise	e_n	$f = 10Hz$ to 100kHz, $C_{BP} = 0.01\mu F$, $C_{OUT} = 10\mu F$, $I_{OUT}=30mA$		$+25^{\circ}C$		68		μV_{RMS}
Output Voltage Temperature Coefficient	$\frac{\Delta V_{OUT}}{\Delta T_A \times V_{OUT}}$	$I_{LOAD} = 0.1mA$		FULL		35		ppm/ $^{\circ}C$
Power Supply Rejection Ratio	PSRR	$C_{BP} = 0\mu F$, $I_{LOAD} = 30mA$, $C_{OUT} = 1\mu F$, $V_{IN} = V_{OUT}+1V$ $\Delta V_{RIPPLE}=0.2V_{P-P}$	$f = 217Hz$	$+25^{\circ}C$		72		dB
			$f = 1kHz$			70		
		$C_{BP} = 10nF$, $I_{LOAD} = 30mA$, $C_{OUT} = 1\mu F$, $V_{IN} = V_{OUT}+1V$ $\Delta V_{RIPPLE}=0.2V_{P-P}$	$f = 217Hz$	$+25^{\circ}C$		74	dB	
			$f = 1kHz$			70		
SHUTDOWN								
EN Input Threshold	V_{IH}	$V_{IN} = 1.7V$			Full	1.4		V
	V_{IL}				Full		0.4	
EN Input Threshold	V_{IH}	$V_{IN} = 7.5V$			Full	2.3		V
	V_{IL}				Full		0.8	
EN Input Bias Current	I_{BH}	$EN = 7.5V$		$+25^{\circ}C$		0.01	1	μA
	I_{BL}	$EN = 0V$		Full		0.01		
Shutdown Supply Current	$I_{Q(SHDN)}$	$EN = 0V$		Full		0.01	1	μA
Start-Up Time ⁽³⁾	t_{STR}	$C_{OUT} = 1\mu F$, No Load		$+25^{\circ}C$		180		μs
R_{ON} of Discharge MOSFET		$V_{IN} = 4.0V$, $V_{EN} = 0V$		$+25^{\circ}C$		260		Ω
THERMAL PROTECTION								
Thermal Shutdown Temperature	T_{SHDN}					150		$^{\circ}C$
Thermal Shutdown Hysteresis	ΔT_{SHDN}					15		$^{\circ}C$

NOTES:

1. $V_{IN} = V_{OUT(NOMINAL)} + 0.5V$ or 1.7V, whichever is greater.

- The dropout voltage is defined as $V_{IN} - V_{OUT}$, when V_{OUT} is 100mV below the value of V_{OUT} for $V_{IN} = V_{OUT} + 0.5V$.
- Time needed for V_{OUT} to reach 90% of final value.

TYPICAL APPLICATION CIRCUIT

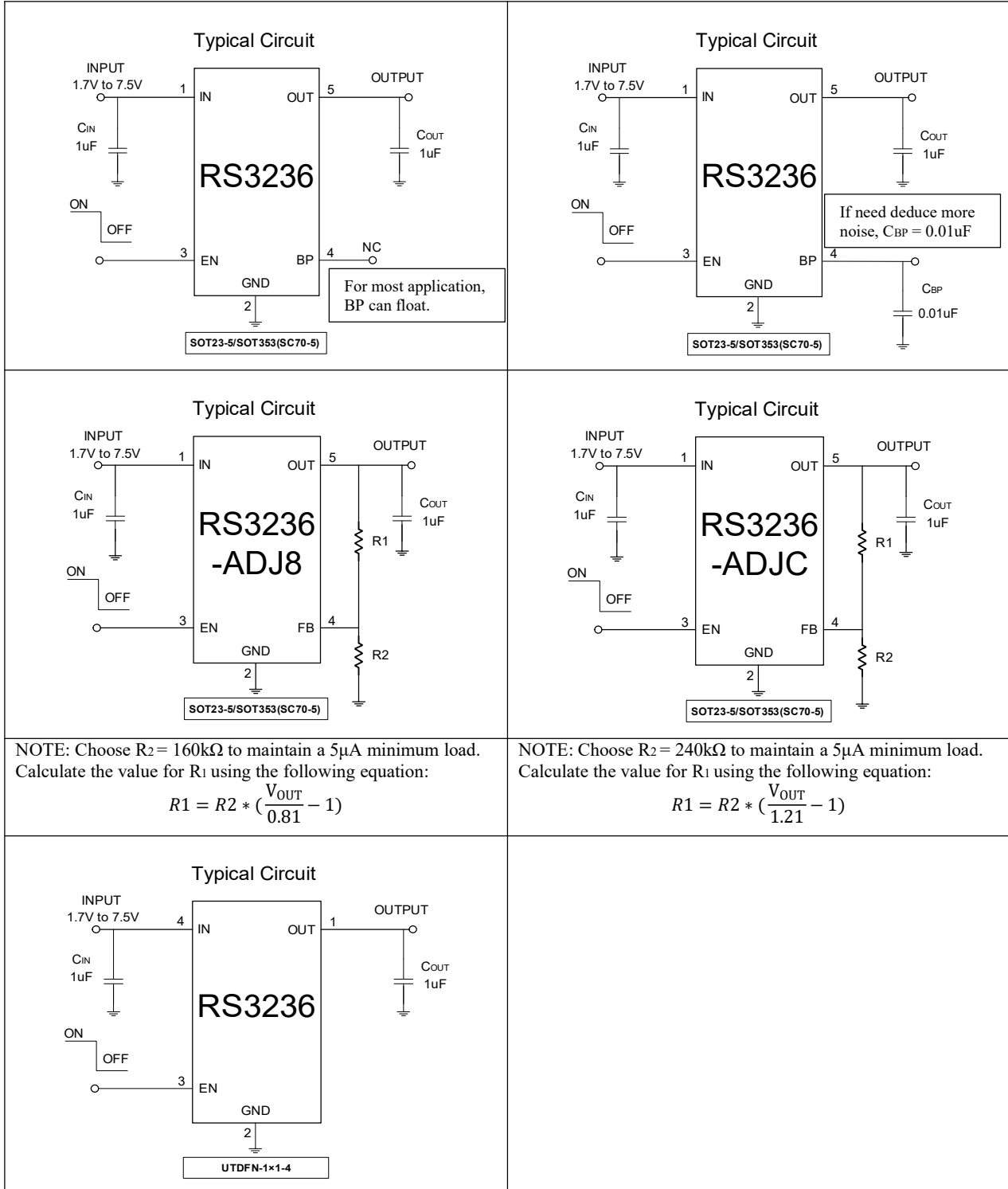

TYPICAL PERFORMANCE CHARACTERISTICS

$V_{IN} = V_{OUT (NOMINAL)} + 0.5V$, $V_{OUT}=3.3V$, $C_{IN} = 1\mu F$, $C_{OUT} = 1\mu F$, $C_{BP} = 0\mu F$, $T_A = +25^\circ C$, unless otherwise noted.

Turn On Speed With EN Pin

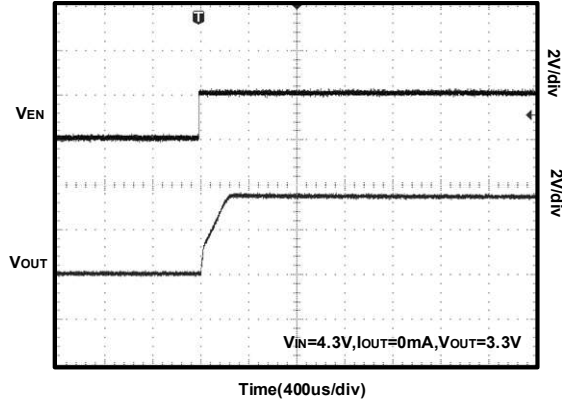

Turn Off Speed With EN Pin

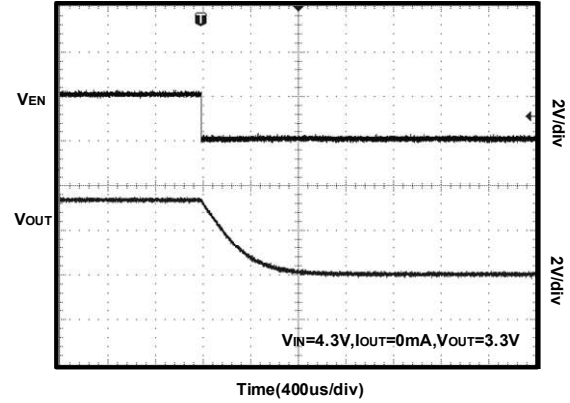

Line Transient Response

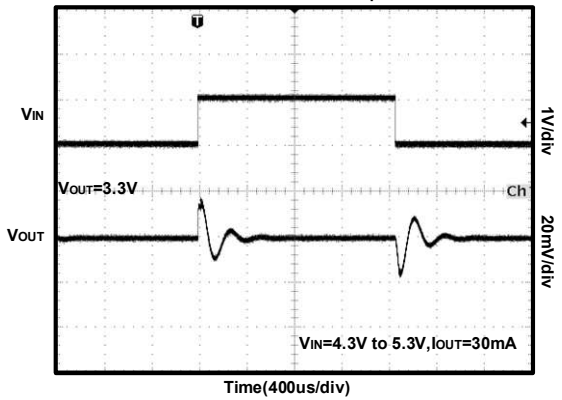

SHUTDOWN

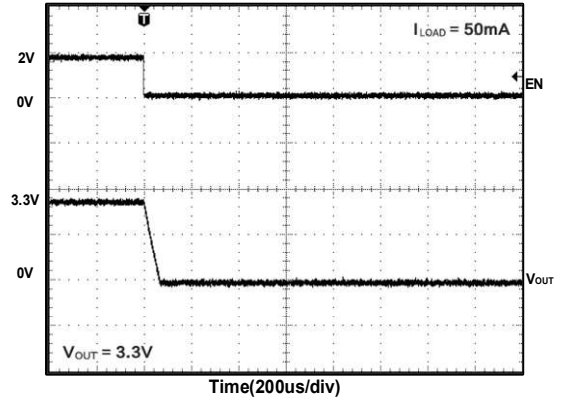

Load Transient Response

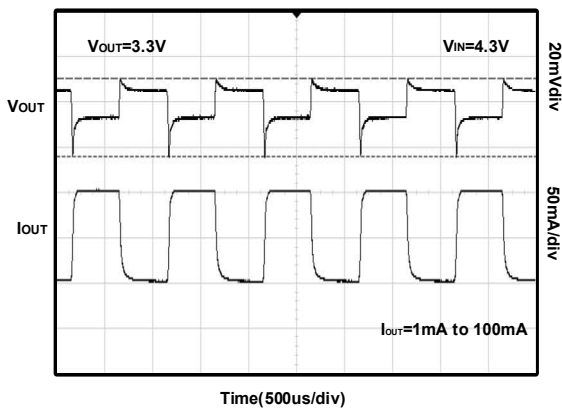

Load Transient Response

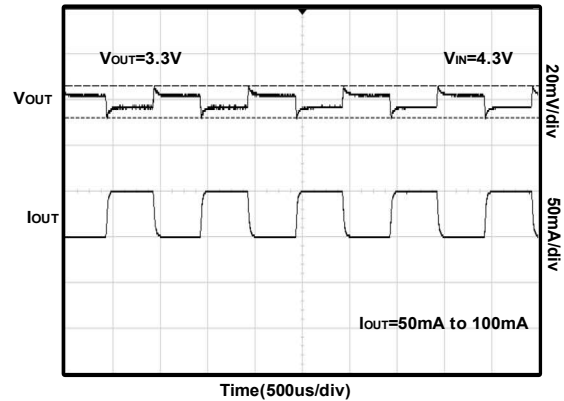

TYPICAL PERFORMANCE CHARACTERISTICS

$V_{IN} = V_{OUT (NOMINAL)} + 0.5V$, $V_{OUT}=3.3V$, $C_{IN} = 1\mu F$, $C_{OUT} = 1\mu F$, $C_{BP} = 0.1\mu F$, $T_A = +25^\circ C$, unless otherwise noted.

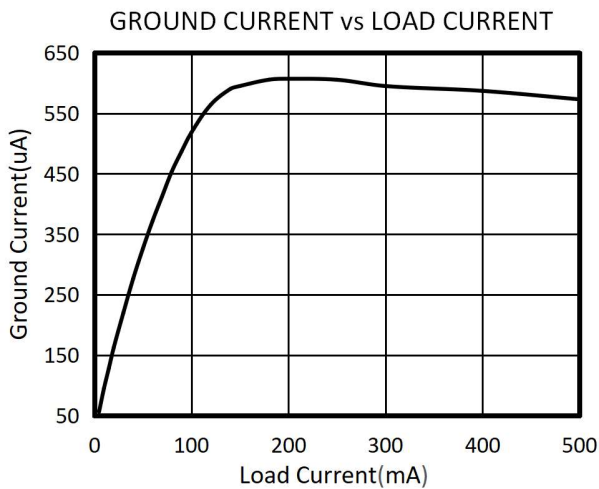
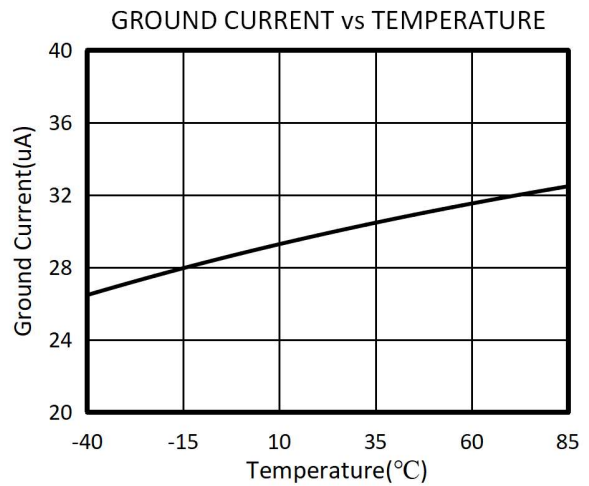
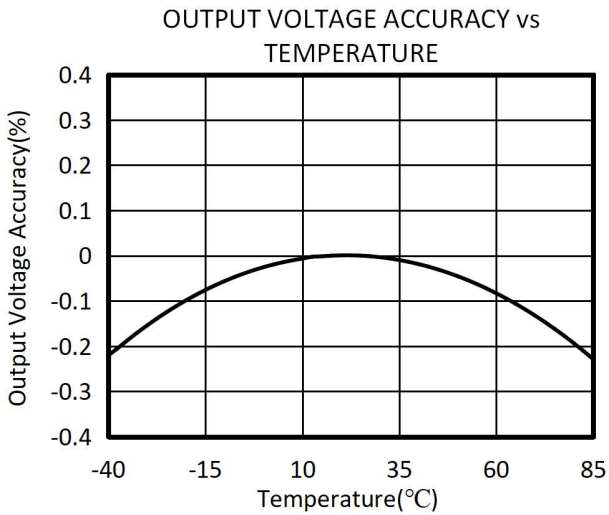
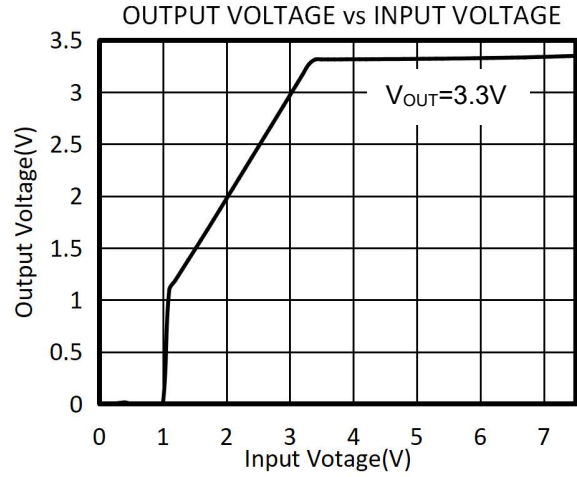
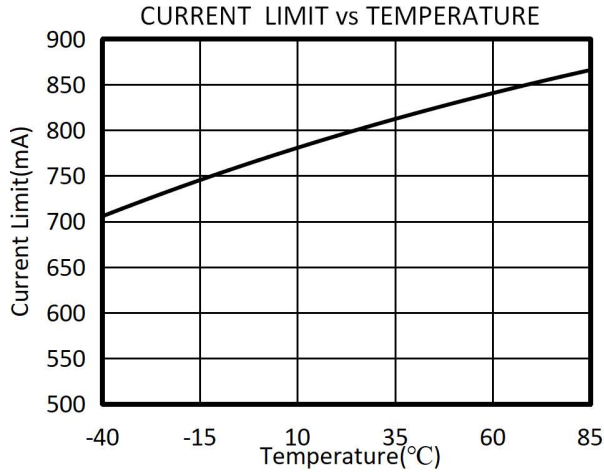

PACKAGE OUTLINE DIMENSIONS

SOT23-3

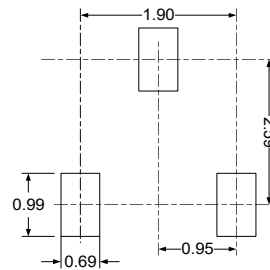
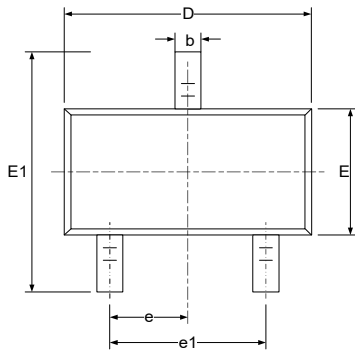
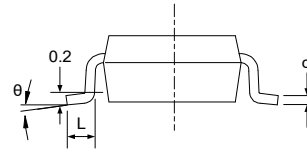
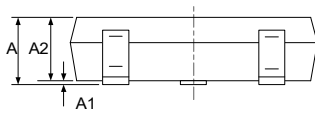
RECOMMENDED LAND PATTERN (Unit: mm)

Symbol	Dimensions In Millimeters		Dimensions In Inches	
	Min	Max	Min	Max
A	1.050	1.250	0.041	0.049
A1	0.000	0.100	0.000	0.004
A2	1.050	1.150	0.041	0.045
b	0.300	0.500	0.012	0.020
c	0.100	0.200	0.004	0.008
D	2.820	3.020	0.111	0.119
E	1.500	1.700	0.059	0.067
E1	2.650	2.950	0.104	0.116
e	0.950(BSC)		0.037(BSC)	
e1	1.800	2.000	0.071	0.079
L	0.300	0.600	0.012	0.024
θ	0°	8°	0°	8°

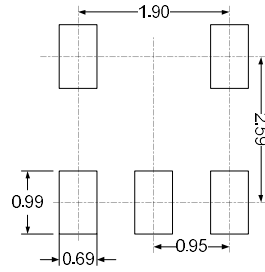
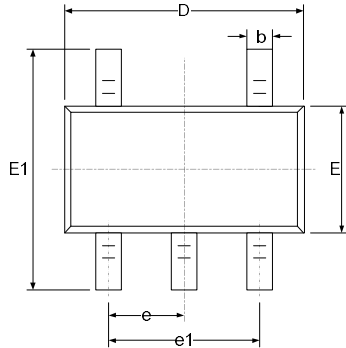
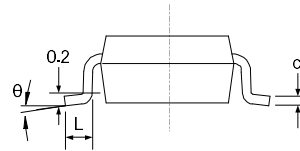
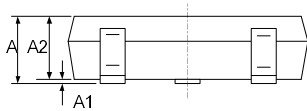
SOT23-5

RECOMMENDED LAND PATTERN (Unit: mm)

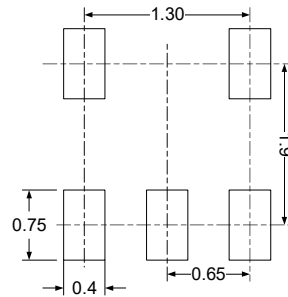
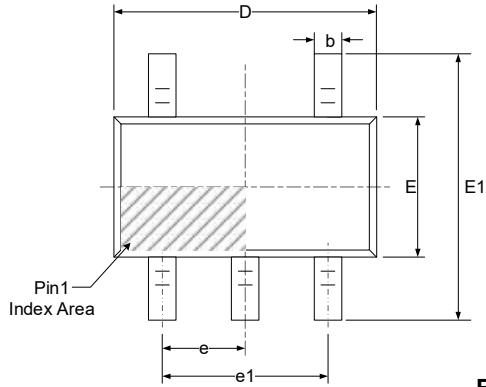
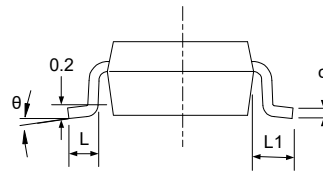
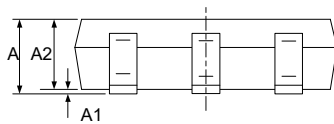
Symbol	Dimensions In Millimeters		Dimensions In Inches	
	Min	Max	Min	Max
A	1.050	1.250	0.041	0.049
A1	0.000	0.100	0.000	0.004
A2	1.050	1.150	0.041	0.045
b	0.300	0.500	0.012	0.020
c	0.100	0.200	0.004	0.008
D	2.820	3.020	0.111	0.119
E	1.500	1.700	0.059	0.067
E1	2.650	2.950	0.104	0.116
e	0.950(BSC)		0.037(BSC)	
e1	1.800	2.000	0.071	0.079
L	0.300	0.600	0.012	0.024
θ	0°	8°	0°	8°

SOT353(SC70-5)

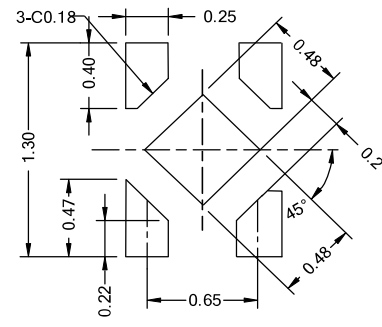
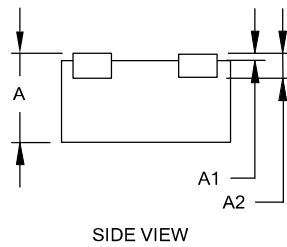
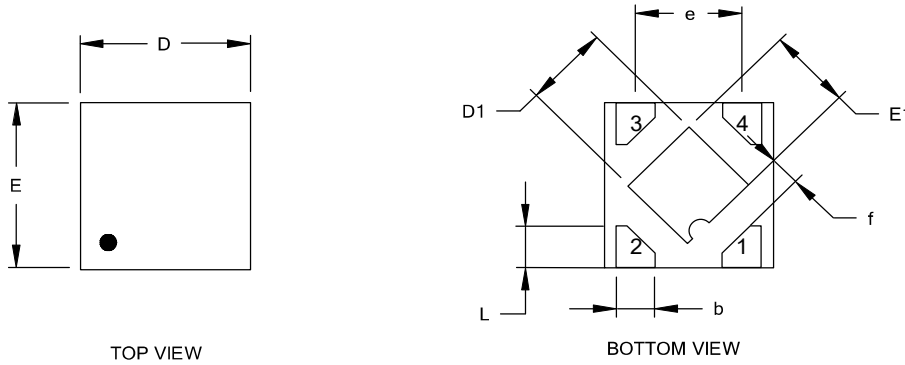
RECOMMENDED LAND PATTERN (Unit: mm)

Symbol	Dimensions In Millimeters		Dimensions In Inches	
	Min	Max	Min	Max
A	0.900	1.100	0.035	0.043
A1	0.000	0.100	0.000	0.004
A2	0.900	1.000	0.035	0.039
b	0.150	0.350	0.006	0.014
c	0.080	0.150	0.003	0.006
D	2.000	2.200	0.079	0.087
E	1.150	1.350	0.045	0.053
E1	2.150	2.450	0.085	0.096
e	0.650(BSC)		0.026(BSC)	
e1	1.300(BSC)		0.051(BSC)	
L	0.260	0.460	0.010	0.018
L1	0.525		0.021	
θ	0°	8°	0°	8°

UTDFN-1x1-4

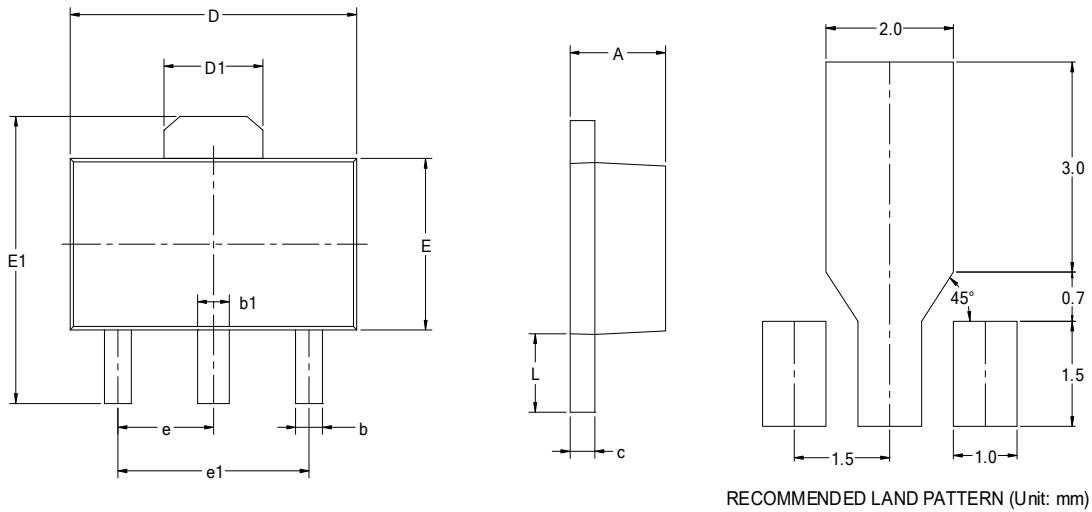
RECOMMENDED LAND PATTERN (Unit: mm)

Symbol	Dimensions In Millimeters			Dimensions In Inches		
	MIN	MOD	MAX	MIN	MOD	MAX
A	0.340	0.370	0.400	0.013	0.015	0.016
A1	0.000	0.020	0.050	0.000	0.001	0.002
A2	0.100 REF			0.004 REF		
D	0.950	1.000	1.050	0.037	0.039	0.041
D1	0.430	0.480	0.530	0.017	0.019	0.021
E	0.950	1.000	1.050	0.037	0.039	0.041
E1	0.430	0.480	0.530	0.017	0.019	0.021
b	0.170	0.220	0.270	0.007	0.009	0.011
e	0.600	0.650	0.700	0.024	0.026	0.028
f	0.195 REF			0.008 REF		
L	0.200	0.250	0.300	0.008	0.010	0.012

SOT89-3L

Symbol	Dimensions In Millimeters		Dimensions In Inches	
	Min	Max	Min	Max
A	1.400	1.600	0.055	0.063
b	0.320	0.520	0.013	0.020
b1	0.400	0.580	0.016	0.023
c	0.350	0.440	0.014	0.017
D	4.400	4.600	0.173	0.181
D1	1.550 REF		0.061 REF	
E	2.300	2.600	0.091	0.102
E1	3.940	4.250	0.155	0.167
e	1.500 BSC		0.060 BSC	
e1	3.000 BSC		0.118 BSC	
L	0.900	1.200	0.035	0.047