

74LVC1G384

Bilateral switch

Rev. 9 — 16 August 2022

Product data sheet

1. General description

The 74LVC1G384 is a single pole, single throw analog switch. It has two input/output terminals (Y and Z) and an enable pin (E). When \bar{E} is HIGH, the analog switch is turned off. Control inputs can be driven from either 3.3 V or 5 V devices. This feature allows the use of these devices as translators in mixed 3.3 V and 5 V environments.

Schmitt-trigger action at control inputs makes the circuit tolerant of slower input rise and fall times.

2. Features and benefits

- Wide supply voltage range from 1.65 V to 5.5 V
- Very low ON resistance:
 - 7.5 Ω (typical) at $V_{CC} = 2.7$ V
 - 6.5 Ω (typical) at $V_{CC} = 3.3$ V
 - 6 Ω (typical) at $V_{CC} = 5$ V
- ESD protection:
 - HBM EIA/JESD22-A114-A exceeds 2000 V
 - MM EIA/JESD22-A115-A exceeds 200 V
- 32 mA continuous switch current
- High noise immunity
- CMOS low power dissipation
- TTL interface compatibility at 3.3 V
- Latch-up performance meets requirements of JESD 78 Class I
- Overvoltage tolerant inputs to 5.5 V
- Multiple package options
- Specified from -40 °C to +85 °C and from -40 °C to +125 °C

3. Ordering information

Table 1. Ordering information

Type number	Package			
	Temperature range	Name	Description	Version
74LVC1G384GW	-40 °C to +125 °C	TSSOP5	plastic thin shrink small outline package; 5 leads; body width 1.25 mm	SOT353-1
74LVC1G384GV	-40 °C to +125 °C	SC-74A	plastic surface-mounted package; 5 leads	SOT753
74LVC1G384GM	-40 °C to +125 °C	XSON6	plastic extremely thin small outline package; no leads; 6 terminals; body 1 × 1.45 × 0.5 mm	SOT886
74LVC1G384GN	-40 °C to +125 °C	XSON6	extremely thin small outline package; no leads; 6 terminals; body 0.9 × 1.0 × 0.35 mm	SOT1115
74LVC1G384GS	-40 °C to +125 °C	XSON6	extremely thin small outline package; no leads; 6 terminals; body 1.0 × 1.0 × 0.35 mm	SOT1202
74LVC1G384GX	-40 °C to +125 °C	X2SON5	plastic thermal enhanced extremely thin small outline package; no leads; 5 terminals; body 0.8 × 0.8 × 0.32 mm	SOT1226-3

4. Marking

Table 2. Marking

Type number	Marking code ^[1]
74LVC1G384GW	YL
74LVC1G384GV	YL
74LVC1G384GM	YL
74LVC1G384GN	YL
74LVC1G384GS	YL
74LVC1G384GX	YL

[1] The pin 1 indicator is located on the lower left corner of the device, below the marking code.

5. Functional diagram

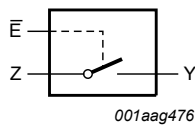

Fig. 1. Logic symbol

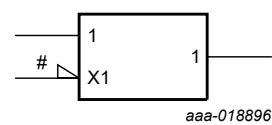

Fig. 2. IEC logic symbol

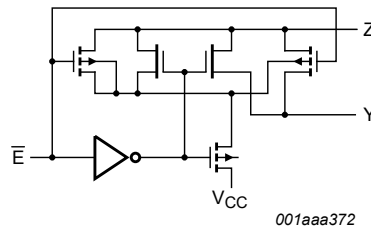

Fig. 3. Logic diagram

6. Pinning information

6.1. Pinning

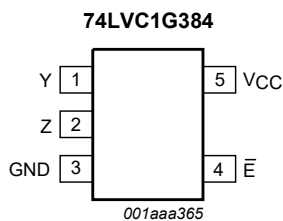

Fig. 4. Pin configuration SOT353-1 (TSSOP5) and SOT753 (SC-74A)

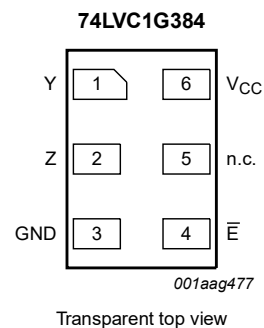
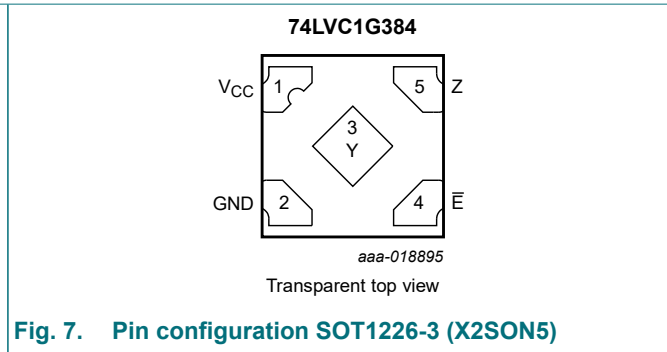
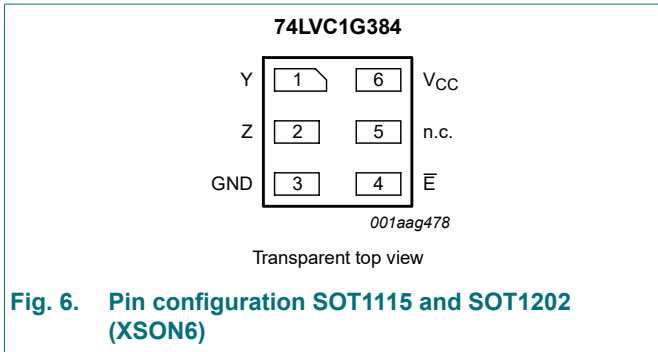

Fig. 5. Pin configuration SOT886 (XSON6)



6.2. Pin description

Table 3. Pin description

Symbol	Pin			Description
	TSSOP5 and SC-74	XSON6	X2SON5	
Y	1	1	3	independent input or output
Z	2	2	5	independent output or input
GND	3	3	2	ground (0 V)
\bar{E}	4	4	4	enable input (active LOW)
n.c.	-	5	-	not connected
V _{CC}	5	6	1	supply voltage

7. Functional description

Table 4. Function table

H = HIGH voltage level; L = LOW voltage level.

Input \bar{E}	Switch
L	ON-state
H	OFF-state

8. Limiting values

Table 5. Limiting values

In accordance with the Absolute Maximum Rating System (IEC 60134). Voltages are referenced to GND (ground = 0 V).

Symbol	Parameter	Conditions	Min	Max	Unit
V_{CC}	supply voltage		-0.5	+6.5	V
V_I	input voltage	[1]	-0.5	+6.5	V
I_{IK}	input clamping current	$V_I < -0.5\text{ V}$ or $V_I > V_{CC} + 0.5\text{ V}$	-50	-	mA
I_{SK}	switch clamping current	$V_I < -0.5\text{ V}$ or $V_I > V_{CC} + 0.5\text{ V}$	-	± 50	mA
V_{SW}	switch voltage	enable and disable mode [2]	-0.5	$V_{CC} + 0.5$	V
I_{SW}	switch current	$V_{SW} > -0.5\text{ V}$ or $V_{SW} < V_{CC} + 0.5\text{ V}$	-	± 50	mA
I_{CC}	supply current		-	100	mA
I_{GND}	ground current		-100	-	mA
T_{stg}	storage temperature		-65	+150	°C
P_{tot}	total power dissipation	$T_{amb} = -40\text{ °C}$ to $+125\text{ °C}$ [3]	-	250	mW

[1] The minimum input voltage rating may be exceeded if the input current rating is observed.

[2] The minimum and maximum switch voltage ratings may be exceeded if the switch clamping current rating is observed.

[3] For SOT353-1 (TSSOP5) package: P_{tot} derates linearly with 3.3 mW/K above 74 °C.

For SOT753 (SC-74A) package: P_{tot} derates linearly with 3.8 mW/K above 85 °C.

For SOT886 (XSON6) package: P_{tot} derates linearly with 3.3 mW/K above 74 °C.

For SOT1115 (XSON6) package: P_{tot} derates linearly with 3.2 mW/K above 71 °C.

For SOT1202 (XSON6) package: P_{tot} derates linearly with 3.3 mW/K above 74 °C.

For SOT1226-3 (X2SON5) package: P_{tot} derates linearly with 3.0 mW/K above 67 °C.

9. Recommended operating conditions

Table 6. Recommended operating conditions

Symbol	Parameter	Conditions	Min	Typ	Max	Unit
V_{CC}	supply voltage		1.65	-	5.5	V
V_I	input voltage		0	-	5.5	V
V_{SW}	switch voltage	[1]	0	-	V_{CC}	V
T_{amb}	ambient temperature		-40	-	+125	°C
$\Delta t/\Delta V$	input transition rise and fall rate	$V_{CC} = 1.65\text{ V}$ to 2.7 V	-	-	20	ns/V
		$V_{CC} = 2.7\text{ V}$ to 5.5 V	-	-	10	ns/V

[1] To avoid sinking GND current from terminal Z when switch current flows in terminal Y, the voltage drop across the bidirectional switch must not exceed 0.4 V. If the switch current flows into terminal Z, no GND current will flow from terminal Y. In this case, there is no limit for the voltage drop across the switch.

10. Static characteristics

Table 7. Static characteristics

At recommended operating conditions; voltages are referenced to GND (ground = 0 V).

Symbol	Parameter	Conditions	-40 °C to +85 °C			-40 °C to +125 °C		Unit
			Min	Typ[1]	Max	Min	Max	
V _{IH}	HIGH-level input voltage	V _{CC} = 1.65 V to 1.95 V	0.65 × V _{CC}	-	-	0.65 × V _{CC}	-	V
		V _{CC} = 2.3 V to 2.7 V	1.7	-	-	1.7	-	V
		V _{CC} = 2.7 V to 3.6 V	2.0	-	-	2.0	-	V
		V _{CC} = 4.5 V to 5.5 V	0.7 × V _{CC}	-	-	0.7 × V _{CC}	-	V
V _{IL}	LOW-level input voltage	V _{CC} = 1.65 V to 1.95 V	-	-	0.35 × V _{CC}	-	0.35 × V _{CC}	V
		V _{CC} = 2.3 V to 2.7 V	-	-	0.7	-	0.7	V
		V _{CC} = 2.7 V to 3.6 V	-	-	0.8	-	0.8	V
		V _{CC} = 4.5 V to 5.5 V	-	-	0.3 × V _{CC}	-	0.3 × V _{CC}	V
I _I	input leakage current	pin \bar{E} ; V _I = 5.5 V or GND; V _{CC} = 0 V to 5.5 V [2]	-	±0.1	±1	-	±1	µA
I _{S(OFF)}	OFF-state leakage current	V _{CC} = 5.5 V; see Fig. 8 [2]	-	±0.1	±0.2	-	±0.5	µA
I _{S(ON)}	ON-state leakage current	V _{CC} = 5.5 V; see Fig. 9 [2]	-	±0.1	±1	-	±2	µA
I _{CC}	supply current	V _I = 5.5 V or GND; V _{SW} = GND or V _{CC} ; V _{CC} = 1.65 V to 5.5 V [2]	-	0.1	4	-	4	µA
ΔI _{CC}	additional supply current	pin \bar{E} ; V _I = V _{CC} - 0.6 V; V _{SW} = GND or V _{CC} ; V _{CC} = 5.5 V [2]	-	5	500	-	500	µA
C _I	input capacitance		-	2.0	-	-	-	pF
C _{S(OFF)}	OFF-state capacitance		-	5.0	-	-	-	pF
C _{S(ON)}	ON-state capacitance		-	9.5	-	-	-	pF

- [1] All typical values are measured at T_{amb} = 25 °C.
- [2] These typical values are measured at V_{CC} = 3.3 V.

10.1. Test circuits

V_I = V_{CC} or GND and V_O = GND or V_{CC}.

Fig. 8. Test circuit for measuring OFF-state leakage current

V_I = V_{CC} or GND and V_O = open circuit.

Fig. 9. Test circuit for measuring ON-state leakage current

10.2. ON resistance

Table 8. ON resistance

At recommended operating conditions; voltages are referenced to GND (ground 0 V); for graphs see Fig. 11 to Fig. 16.

Symbol	Parameter	Conditions	-40 °C to +85 °C			-40 °C to +125 °C		Unit		
			Min	Typ[1]	Max	Min	Max			
R _{ON(peak)}	ON resistance (peak)	V _I = GND to V _{CC} ; see Fig. 10								
		I _{SW} = 4 mA; V _{CC} = 1.65 V to 1.95 V	-	34.0	130	-	195	Ω		
		I _{SW} = 8 mA; V _{CC} = 2.3 V to 2.7 V	-	12.0	30	-	45	Ω		
		I _{SW} = 12 mA; V _{CC} = 2.7 V	-	10.4	25	-	38	Ω		
		I _{SW} = 24 mA; V _{CC} = 3 V to 3.6 V	-	7.8	20	-	30	Ω		
		I _{SW} = 32 mA; V _{CC} = 4.5 V to 5.5 V	-	6.2	15	-	23	Ω		
R _{ON(rail)}	ON resistance (rail)	V _I = GND; see Fig. 10								
		I _{SW} = 4 mA; V _{CC} = 1.65 V to 1.95 V	-	8.2	18	-	27	Ω		
		I _{SW} = 8 mA; V _{CC} = 2.3 V to 2.7 V	-	7.1	16	-	24	Ω		
		I _{SW} = 12 mA; V _{CC} = 2.7 V	-	6.9	14	-	21	Ω		
		I _{SW} = 24 mA; V _{CC} = 3 V to 3.6 V	-	6.5	12	-	18	Ω		
		I _{SW} = 32 mA; V _{CC} = 4.5 V to 5.5 V	-	5.8	10	-	15	Ω		
		V _I = V _{CC} ; see Fig. 10				-				
		I _{SW} = 4 mA; V _{CC} = 1.65 V to 1.95 V	-	10.4	30	-	45	Ω		
		I _{SW} = 8 mA; V _{CC} = 2.3 V to 2.7 V	-	7.6	20	-	30	Ω		
		I _{SW} = 12 mA; V _{CC} = 2.7 V	-	7.0	18	-	27	Ω		
		I _{SW} = 24 mA; V _{CC} = 3 V to 3.6 V	-	6.1	15	-	23	Ω		
		I _{SW} = 32 mA; V _{CC} = 4.5 V to 5.5 V	-	4.9	10	-	15	Ω		
		R _{ON(flat)}	ON resistance (flatness)	V _I = GND to V _{CC} [2]						
				I _{SW} = 4 mA; V _{CC} = 1.65 V to 1.95 V	-	26.0	-	-	-	Ω
I _{SW} = 8 mA; V _{CC} = 2.3 V to 2.7 V	-			5.0	-	-	-	Ω		
I _{SW} = 12 mA; V _{CC} = 2.7 V	-			3.5	-	-	-	Ω		
I _{SW} = 24 mA; V _{CC} = 3 V to 3.6 V	-			2.0	-	-	-	Ω		
I _{SW} = 32 mA; V _{CC} = 4.5 V to 5.5 V	-			1.5	-	-	-	Ω		

[1] Typical values are measured at T_{amb} = 25 °C and nominal V_{CC}.

[2] Flatness is defined as the difference between the maximum and minimum value of ON resistance measured at identical V_{CC} and temperature.

10.3. ON resistance test circuit and graphs

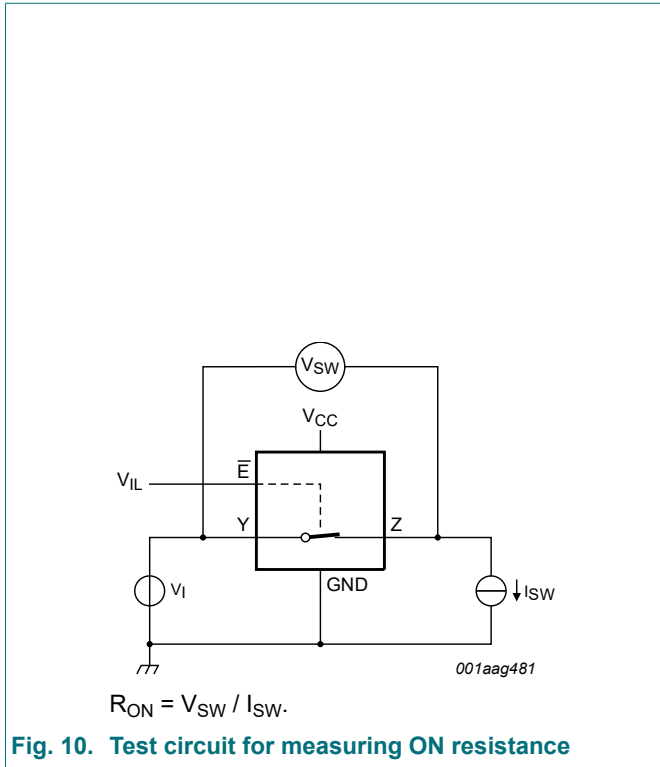

Fig. 10. Test circuit for measuring ON resistance

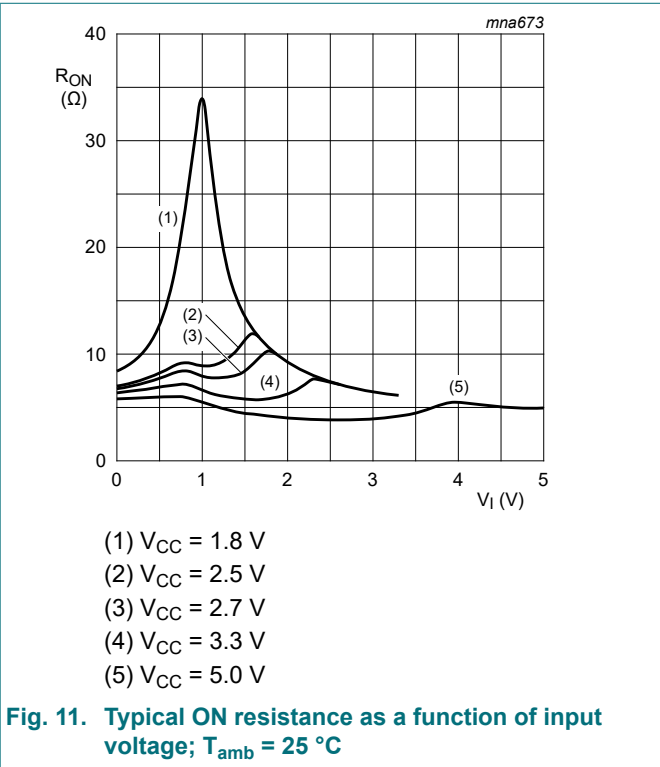

Fig. 11. Typical ON resistance as a function of input voltage; $T_{amb} = 25\text{ }^{\circ}\text{C}$

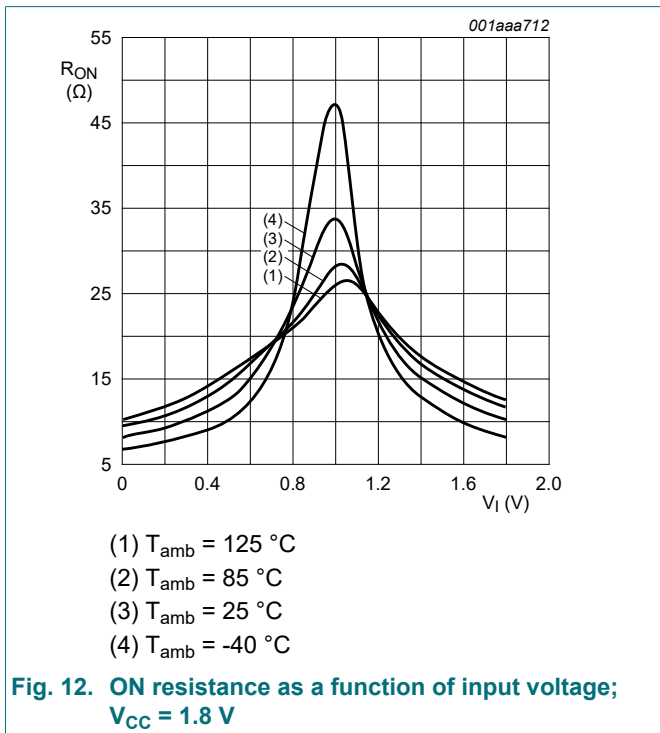

Fig. 12. ON resistance as a function of input voltage; $V_{CC} = 1.8\text{ V}$

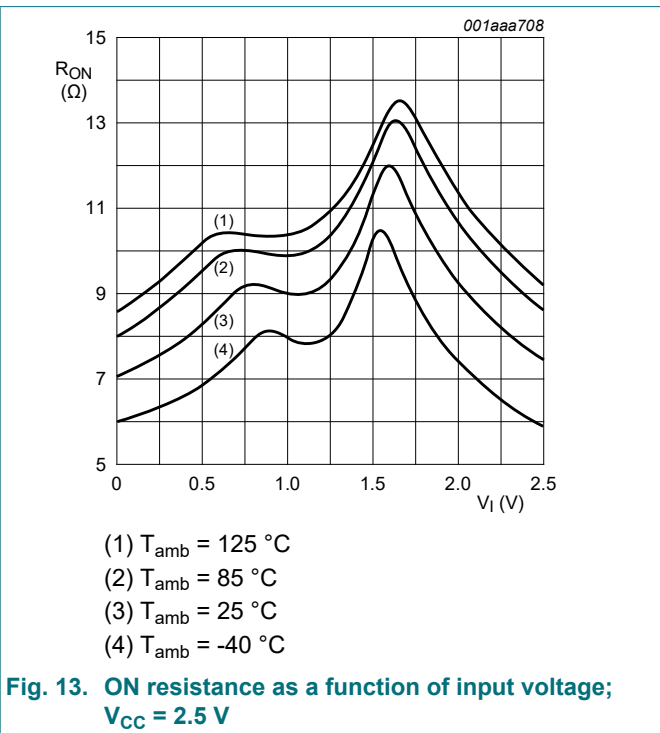
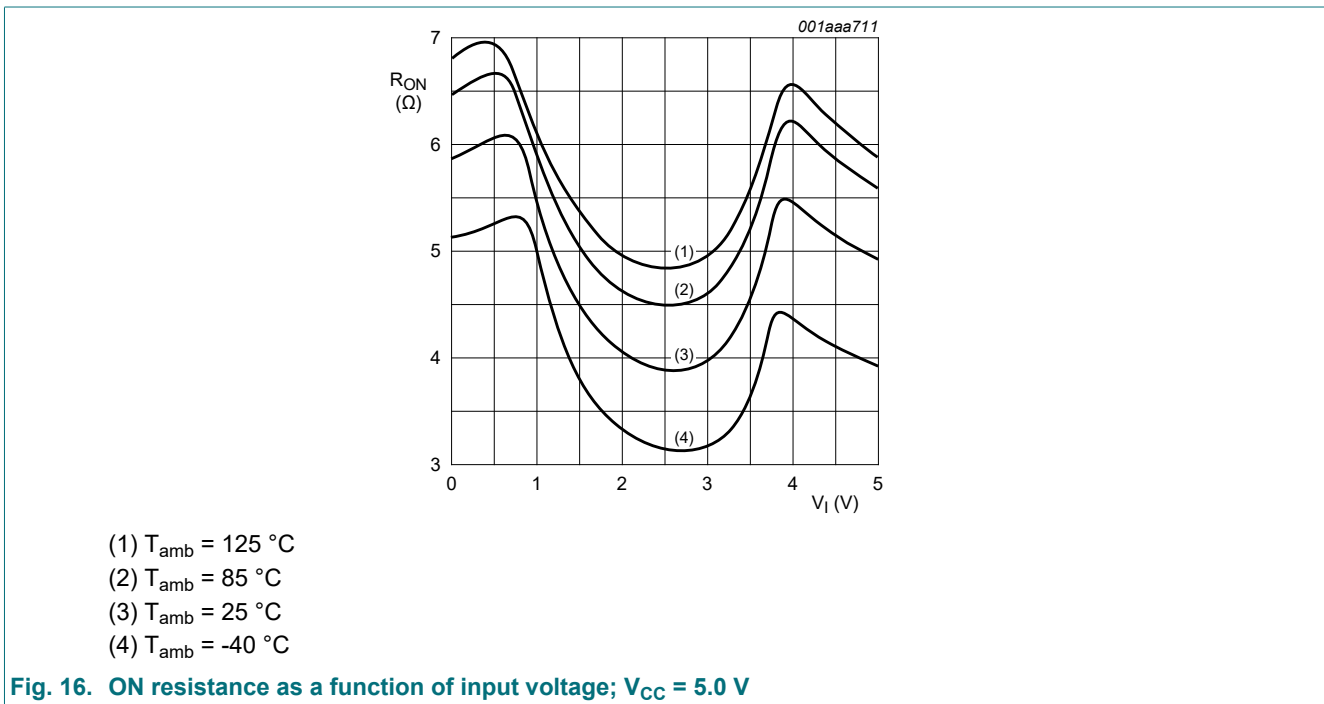
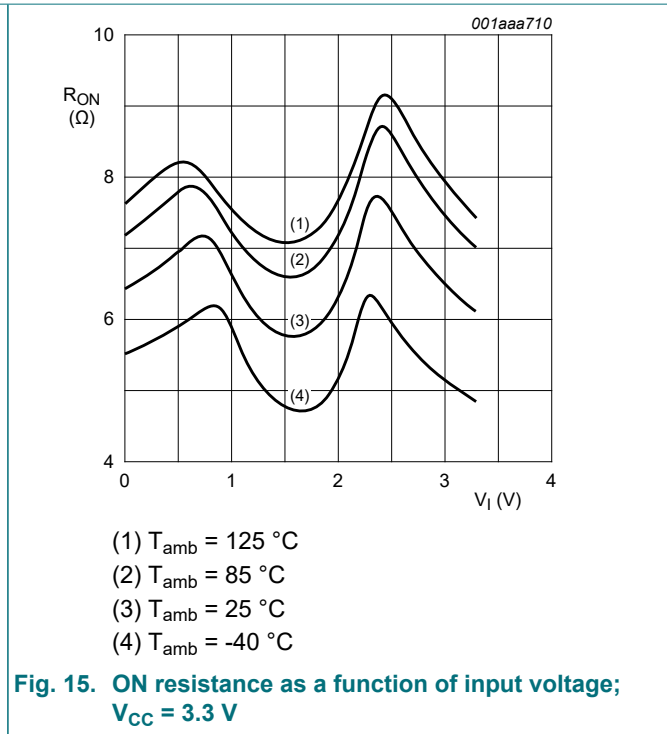
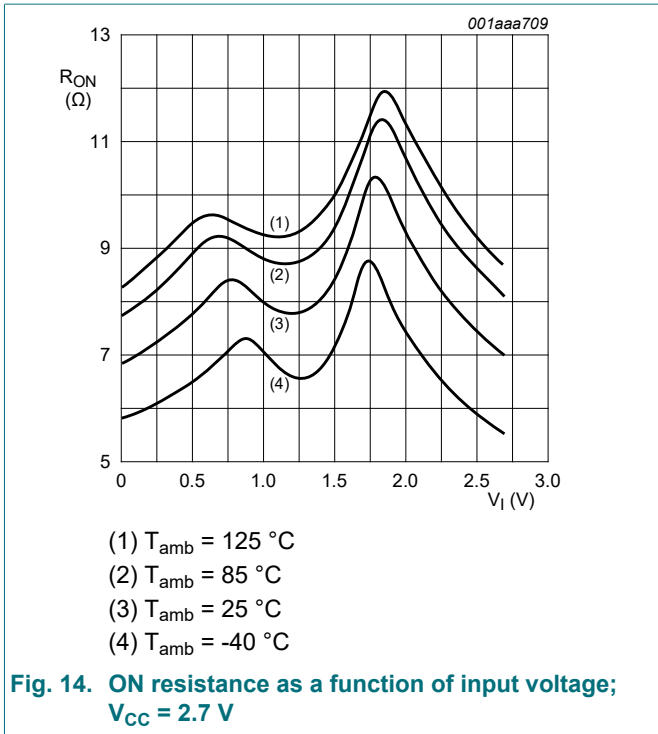

Fig. 13. ON resistance as a function of input voltage; $V_{CC} = 2.5\text{ V}$



11. Dynamic characteristics

Table 9. Dynamic characteristics

At recommended operating conditions; voltages are referenced to GND (ground = 0 V); for test circuit see Fig. 19.

Symbol	Parameter	Conditions	-40 °C to +85 °C			-40 °C to +125 °C		Unit
			Min	Typ[1]	Max	Min	Max	
t _{pd}	propagation delay	Y to Z or Z to Y; see Fig. 17 [2][3]						
		V _{CC} = 1.65 V to 1.95 V	-	0.8	2.0	-	3.0	ns
		V _{CC} = 2.3 V to 2.7 V	-	0.4	1.2	-	2.0	ns
		V _{CC} = 2.7 V	-	0.4	1.0	-	1.5	ns
		V _{CC} = 3.0 V to 3.6 V	-	0.3	0.8	-	1.5	ns
		V _{CC} = 4.5 V to 5.5 V	-	0.2	0.6	-	1.0	ns
t _{en}	enable time	\bar{E} to Y or Z; see Fig. 18 [4]						
		V _{CC} = 1.65 V to 1.95 V	1.0	10.0	12.0	1.0	15.5	ns
		V _{CC} = 2.3 V to 2.7 V	1.0	5.7	6.5	1.0	8.5	ns
		V _{CC} = 2.7 V	1.0	5.4	6.0	1.0	8.0	ns
		V _{CC} = 3.0 V to 3.6 V	1.0	4.8	5.0	1.0	6.5	ns
		V _{CC} = 4.5 V to 5.5 V	1.0	3.3	4.2	1.0	5.5	ns
t _{dis}	disable time	\bar{E} to Y or Z; see Fig. 18 [5]						
		V _{CC} = 1.65 V to 1.95 V	1.0	7.4	10.0	1.0	13.0	ns
		V _{CC} = 2.3 V to 2.7 V	1.0	4.1	6.9	1.0	9.0	ns
		V _{CC} = 2.7 V	1.0	4.9	7.5	1.0	9.5	ns
		V _{CC} = 3.0 V to 3.6 V	1.0	5.4	6.5	1.0	8.5	ns
		V _{CC} = 4.5 V to 5.5 V	1.0	3.6	5.0	1.0	6.5	ns
C _{PD}	power dissipation capacitance	C _L = 50 pF; f _i = 10 MHz; V _I = GND to V _{CC} [6]						
		V _{CC} = 2.5 V	-	13.7	-	-	-	pF
		V _{CC} = 3.3 V	-	15.2	-	-	-	pF
		V _{CC} = 5.0 V	-	18.3	-	-	-	pF

[1] Typical values are measured at T_{amb} = 25 °C and nominal V_{CC}.

[2] Propagation delay is the calculated RC time constant of the typical ON resistance of the switch and the specified capacitance when driven by an ideal voltage source (zero output impedance).

[3] t_{pd} is the same as t_{PLH} and t_{PHL}.

[4] t_{en} is the same as t_{PZH} and t_{PZL}.

[5] t_{dis} is the same as t_{PLZ} and t_{PHZ}.

[6] C_{PD} is used to determine the dynamic power dissipation (P_D in μW).

$$P_D = C_{PD} \times V_{CC}^2 \times f_i \times N + \Sigma\{(C_L + C_{S(ON)}) \times V_{CC}^2 \times f_o\} \text{ where:}$$

f_i = input frequency in MHz;

f_o = output frequency in MHz;

C_L = output load capacitance in pF;

C_{S(ON)} = maximum ON-state switch capacitance in pF;

V_{CC} = supply voltage in V;

N = number of inputs switching;

Σ{(C_L + C_{S(ON)}) × V_{CC}² × f_o} = sum of the outputs.

11.1. Waveforms and test circuit

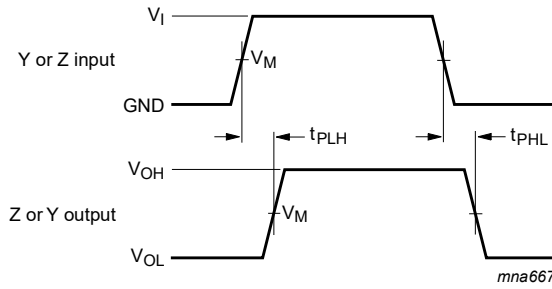

Measurement points are given in [Table 10](#).

Logic levels: V_{OL} and V_{OH} are typical output voltage levels that occur with the output load.

Fig. 17. Input (Y or Z) to output (Z or Y) propagation delays

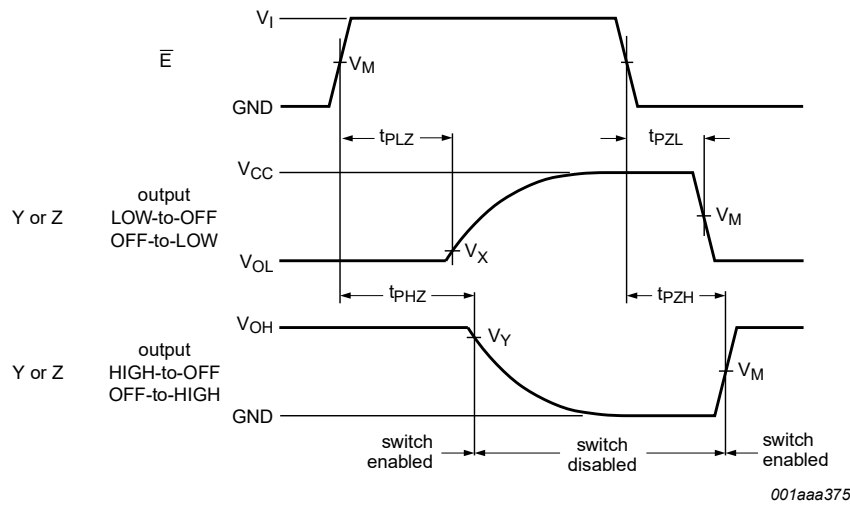

Measurement points are given in [Table 10](#).

Logic levels: V_{OL} and V_{OH} are typical output voltage levels that occur with the output load.

Fig. 18. Enable and disable times

Table 10. Measurement points

Supply voltage	Input	Output		
V_{CC}	V_M	V_M	V_X	V_Y
1.65 V to 1.95 V	$0.5 \times V_{CC}$	$0.5 \times V_{CC}$	$V_{OL} + 0.15 \text{ V}$	$V_{OH} - 0.15 \text{ V}$
2.3 V to 2.7 V	$0.5 \times V_{CC}$	$0.5 \times V_{CC}$	$V_{OL} + 0.15 \text{ V}$	$V_{OH} - 0.15 \text{ V}$
2.7 V	1.5 V	1.5 V	$V_{OL} + 0.3 \text{ V}$	$V_{OH} - 0.3 \text{ V}$
3.0 V to 3.6 V	1.5 V	1.5 V	$V_{OL} + 0.3 \text{ V}$	$V_{OH} - 0.3 \text{ V}$
4.5 V to 5.5 V	$0.5 \times V_{CC}$	$0.5 \times V_{CC}$	$V_{OL} + 0.3 \text{ V}$	$V_{OH} - 0.3 \text{ V}$

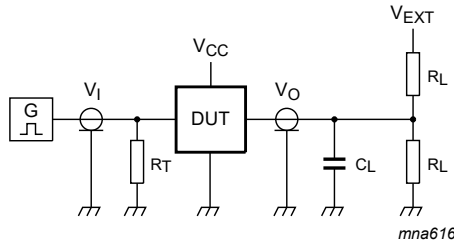

Test data is given in [Table 11](#).

Definitions for test circuit:

R_T = Termination resistance should be equal to output impedance Z_o of the pulse generator;

C_L = Load capacitance including jig and probe capacitance;

R_L = Load resistance;

V_{EXT} = External voltage for measuring switching times.

Fig. 19. Test circuit for measuring switching times

Table 11. Test data

Supply voltage	Input		Load		V_{EXT}		
V_{CC}	V_I	t_r, t_f	C_L	R_L	t_{PLH}, t_{PHL}	t_{PZH}, t_{PHZ}	t_{PZL}, t_{PLZ}
1.65 V to 1.95 V	V_{CC}	≤ 2.0 ns	30 pF	1 k Ω	open	GND	$2 \times V_{CC}$
2.3 V to 2.7 V	V_{CC}	≤ 2.0 ns	30 pF	500 Ω	open	GND	$2 \times V_{CC}$
2.7 V	2.7 V	≤ 2.5 ns	50 pF	500 Ω	open	GND	6 V
3.0 V to 3.6 V	2.7 V	≤ 2.5 ns	50 pF	500 Ω	open	GND	6 V
4.5 V to 5.5 V	V_{CC}	≤ 2.5 ns	50 pF	500 Ω	open	GND	$2 \times V_{CC}$

11.2. Additional dynamic characteristics

Table 12. Additional dynamic characteristics

At recommended operating conditions; typical values measured at $T_{amb} = 25$ °C.

Symbol	Parameter	Conditions	Min	Typ	Max	Unit	
THD	total harmonic distortion	$R_L = 10$ k Ω ; $C_L = 50$ pF; $f_i = 1$ kHz; see Fig. 20					
		$V_{CC} = 1.65$ V	-	0.032	-	%	
		$V_{CC} = 2.3$ V	-	0.008	-	%	
		$V_{CC} = 3.0$ V	-	0.006	-	%	
		$V_{CC} = 4.5$ V	-	0.001	-	%	
		$R_L = 10$ k Ω ; $C_L = 50$ pF; $f_i = 10$ kHz; see Fig. 20					
		$V_{CC} = 1.65$ V	-	0.068	-	%	
		$V_{CC} = 2.3$ V	-	0.009	-	%	
		$V_{CC} = 3.0$ V	-	0.008	-	%	
		$V_{CC} = 4.5$ V	-	0.006	-	%	

Symbol	Parameter	Conditions	Min	Typ	Max	Unit
$f_{(-3dB)}$	-3 dB frequency response	$R_L = 600 \Omega$; $C_L = 50 \text{ pF}$; see Fig. 21				
		$V_{CC} = 1.65 \text{ V}$	-	135	-	MHz
		$V_{CC} = 2.3 \text{ V}$	-	145	-	MHz
		$V_{CC} = 3.0 \text{ V}$	-	150	-	MHz
		$V_{CC} = 4.5 \text{ V}$	-	155	-	MHz
		$R_L = 50 \Omega$; $C_L = 5 \text{ pF}$; see Fig. 21				
		$V_{CC} = 1.65 \text{ V}$	-	> 500	-	MHz
		$V_{CC} = 2.3 \text{ V}$	-	> 500	-	MHz
		$V_{CC} = 3.0 \text{ V}$	-	> 500	-	MHz
		$V_{CC} = 4.5 \text{ V}$	-	> 500	-	MHz
		$R_L = 50 \Omega$; $C_L = 10 \text{ pF}$; see Fig. 21				
		$V_{CC} = 1.65 \text{ V}$	-	200	-	MHz
		$V_{CC} = 2.3 \text{ V}$	-	350	-	MHz
		$V_{CC} = 3.0 \text{ V}$	-	410	-	MHz
$V_{CC} = 4.5 \text{ V}$	-	440	-	MHz		
α_{iso}	isolation (OFF-state)	$R_L = 600 \Omega$; $C_L = 50 \text{ pF}$; $f_i = 1 \text{ MHz}$; see Fig. 22				
		$V_{CC} = 1.65 \text{ V}$	-	-46	-	dB
		$V_{CC} = 2.3 \text{ V}$	-	-46	-	dB
		$V_{CC} = 3.0 \text{ V}$	-	-46	-	dB
		$V_{CC} = 4.5 \text{ V}$	-	-46	-	dB
		$R_L = 50 \Omega$; $C_L = 5 \text{ pF}$; $f_i = 1 \text{ MHz}$; see Fig. 22				
		$V_{CC} = 1.65 \text{ V}$	-	-37	-	dB
		$V_{CC} = 2.3 \text{ V}$	-	-37	-	dB
		$V_{CC} = 3.0 \text{ V}$	-	-37	-	dB
		$V_{CC} = 4.5 \text{ V}$	-	-37	-	dB
V_{ct}	crosstalk voltage	between digital input and switch; $R_L = 600 \Omega$; $C_L = 50 \text{ pF}$; $f_i = 1 \text{ MHz}$; $t_r = t_f = 2 \text{ ns}$; see Fig. 23				
		$V_{CC} = 1.65 \text{ V}$	-	69	-	mV
		$V_{CC} = 2.3 \text{ V}$	-	87	-	mV
		$V_{CC} = 3.0 \text{ V}$	-	156	-	mV
		$V_{CC} = 4.5 \text{ V}$	-	302	-	mV
Q_{inj}	charge injection	$C_L = 0.1 \text{ nF}$; $V_{gen} = 0 \text{ V}$; $R_{gen} = 0 \Omega$; $f_i = 1 \text{ MHz}$; $R_L = 1 \text{ M}\Omega$; see Fig. 24				
		$V_{CC} = 1.8 \text{ V}$	-	3.3	-	pC
		$V_{CC} = 2.5 \text{ V}$	-	4.1	-	pC
		$V_{CC} = 3.3 \text{ V}$	-	5.0	-	pC
		$V_{CC} = 4.5 \text{ V}$	-	6.4	-	pC
		$V_{CC} = 5.5 \text{ V}$	-	7.5	-	pC

11.3. Test circuits

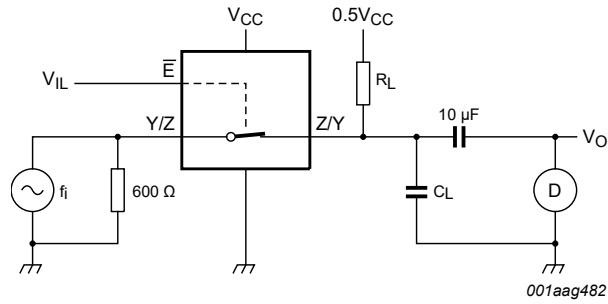

Test conditions:

- $V_{CC} = 1.65\text{ V}$: $V_I = 1.4\text{ V (p-p)}$
- $V_{CC} = 2.3\text{ V}$: $V_I = 2\text{ V (p-p)}$
- $V_{CC} = 3\text{ V}$: $V_I = 2.5\text{ V (p-p)}$
- $V_{CC} = 4.5\text{ V}$: $V_I = 4\text{ V (p-p)}$

Fig. 20. Test circuit for measuring total harmonic distortion

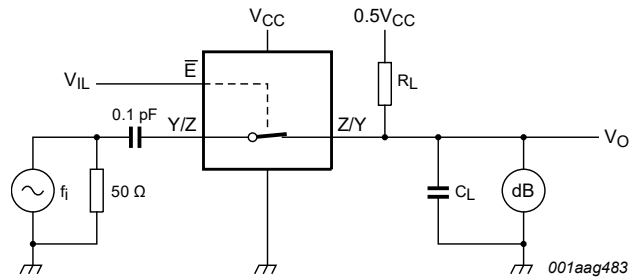

Adjust f_i voltage to obtain 0 dBm level at output. Increase f_i frequency until dB meter reads -3 dB.

Fig. 21. Test circuit for measuring the frequency response when switch is in ON-state

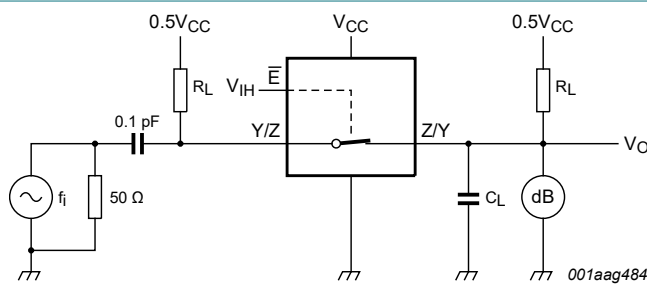

Adjust f_i voltage to obtain 0 dBm level at input.

Fig. 22. Test circuit for measuring isolation (OFF-state)

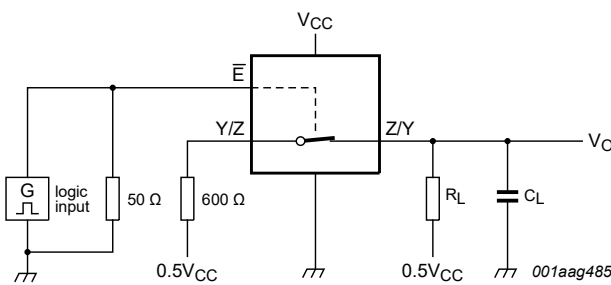

Fig. 23. Test circuit for measuring crosstalk between digital inputs and switch

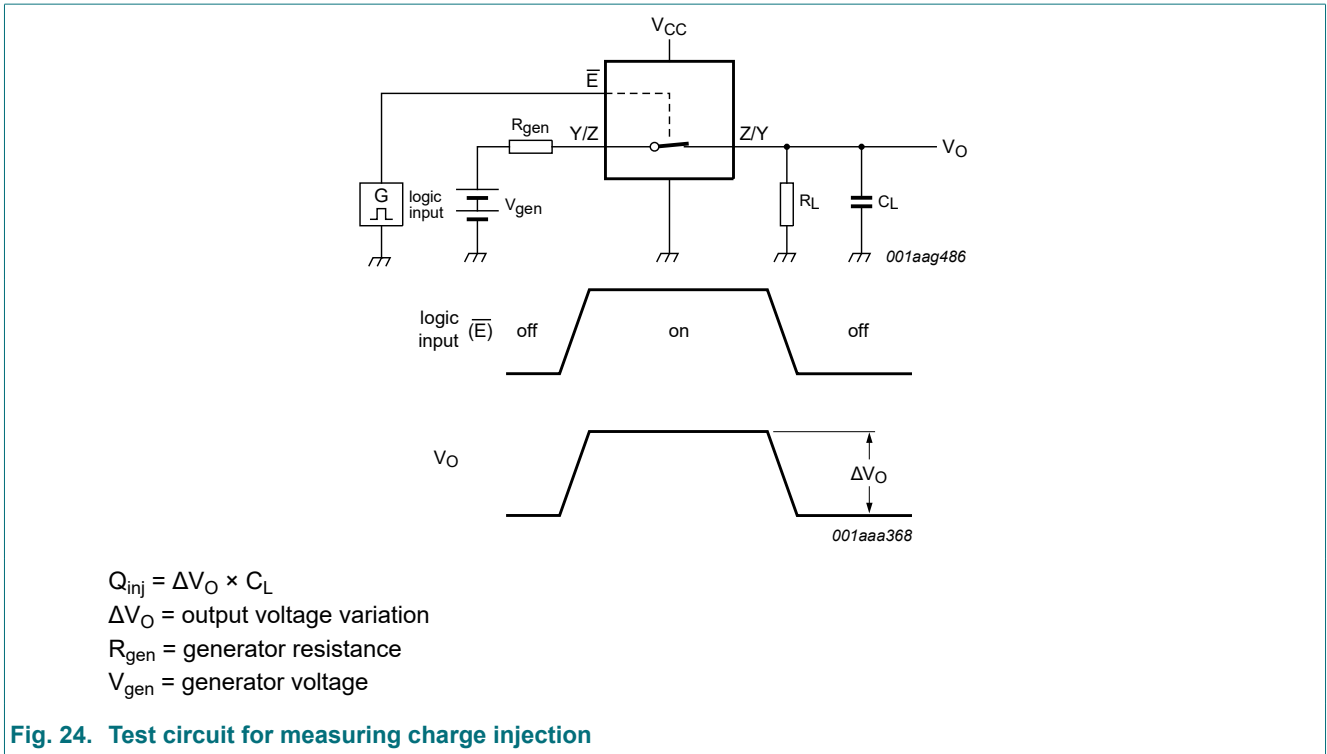

Fig. 24. Test circuit for measuring charge injection

12. Package outline

TSSOP5: plastic thin shrink small outline package; 5 leads; body width 1.25 mm

SOT353-1



Fig. 25. Package outline SOT353-1 (TSSOP5)

Plastic surface-mounted package; 5 leads

SOT753

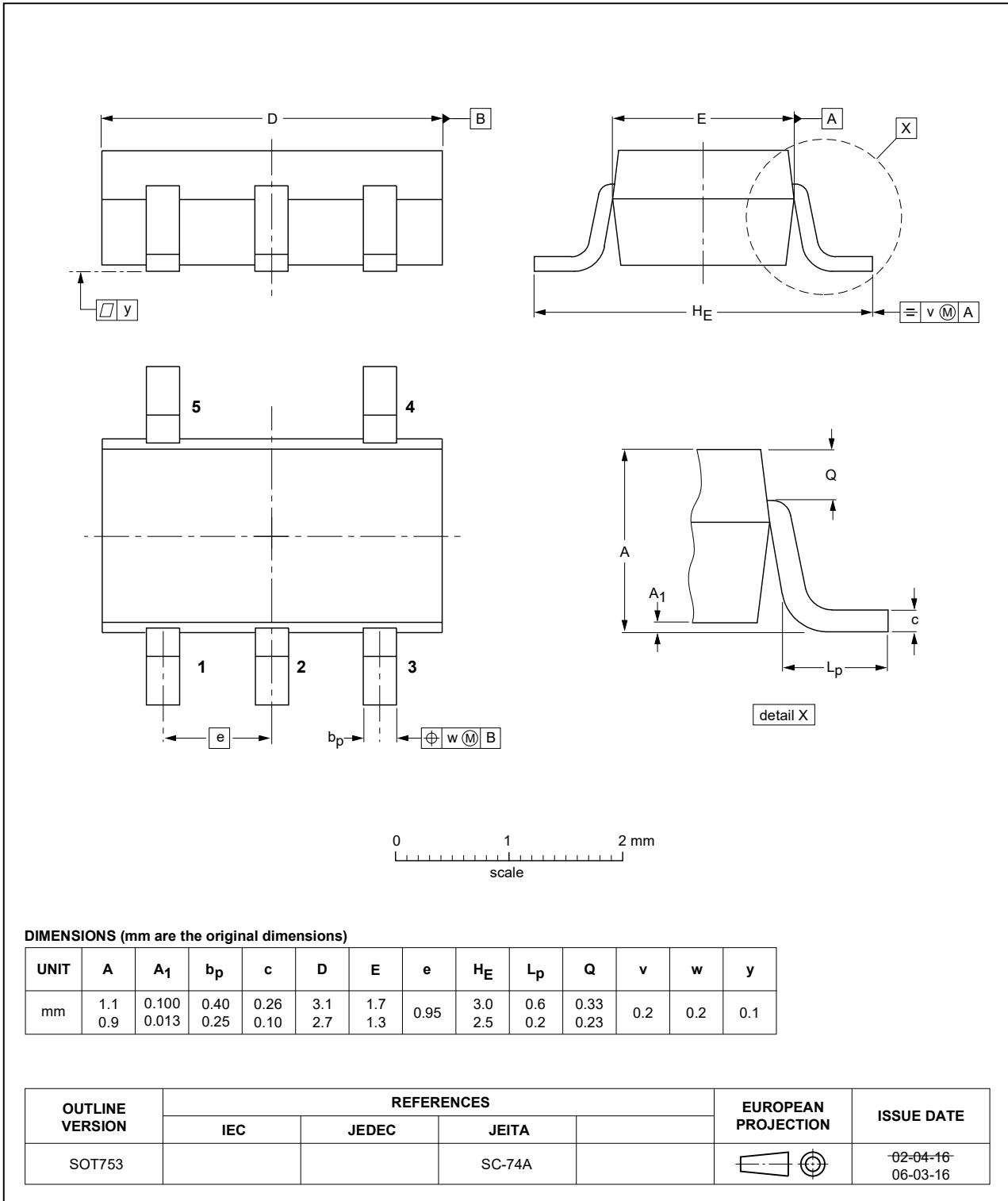

Fig. 26. Package outline SOT753 (SC-74A)

XSON6: plastic extremely thin small outline package; no leads; 6 terminals; body 1 x 1.45 x 0.5 mm

SOT886

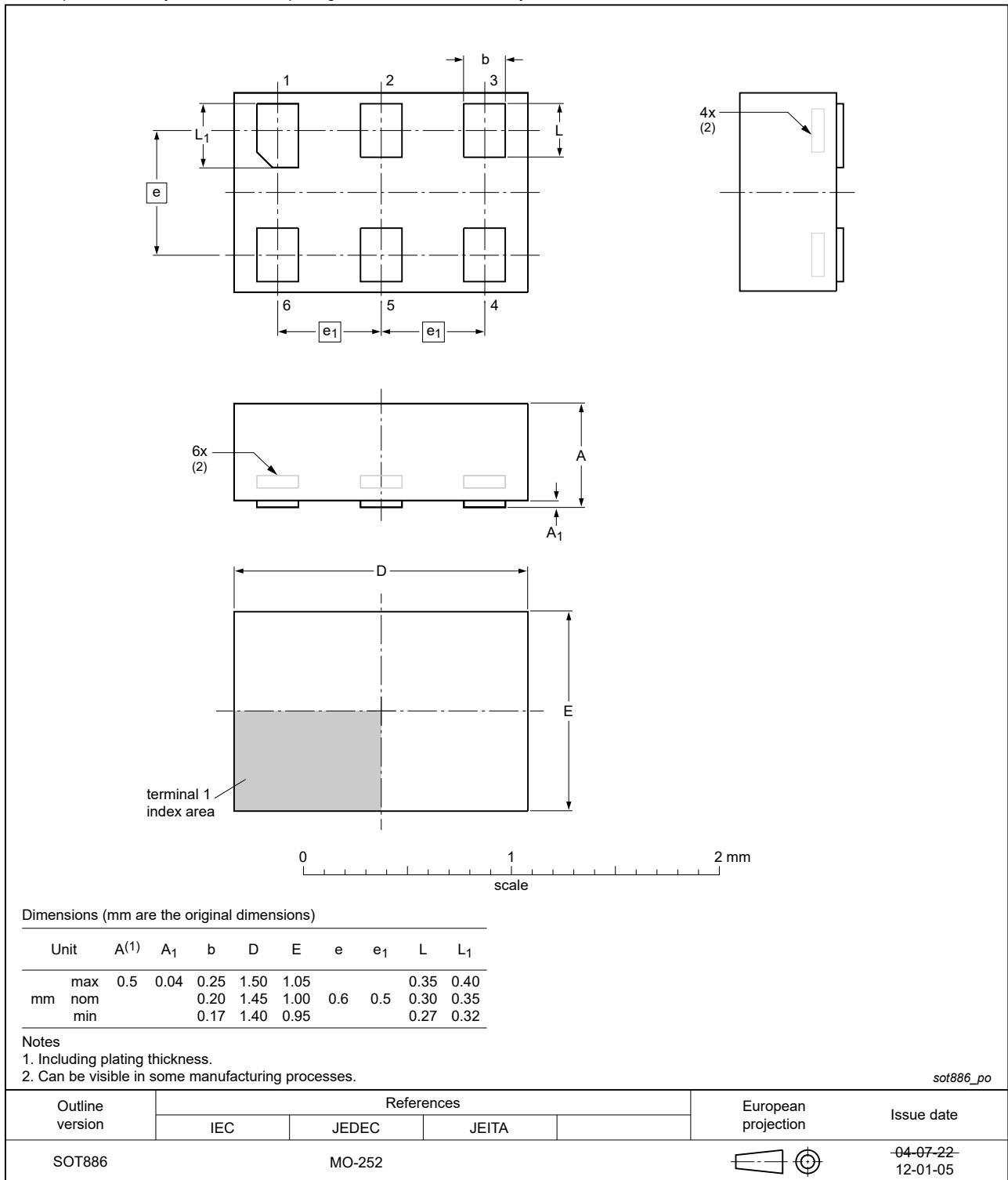

Fig. 27. Package outline SOT886 (XSON6)

XSON6: extremely thin small outline package; no leads;
6 terminals; body 0.9 x 1.0 x 0.35 mm

SOT1115

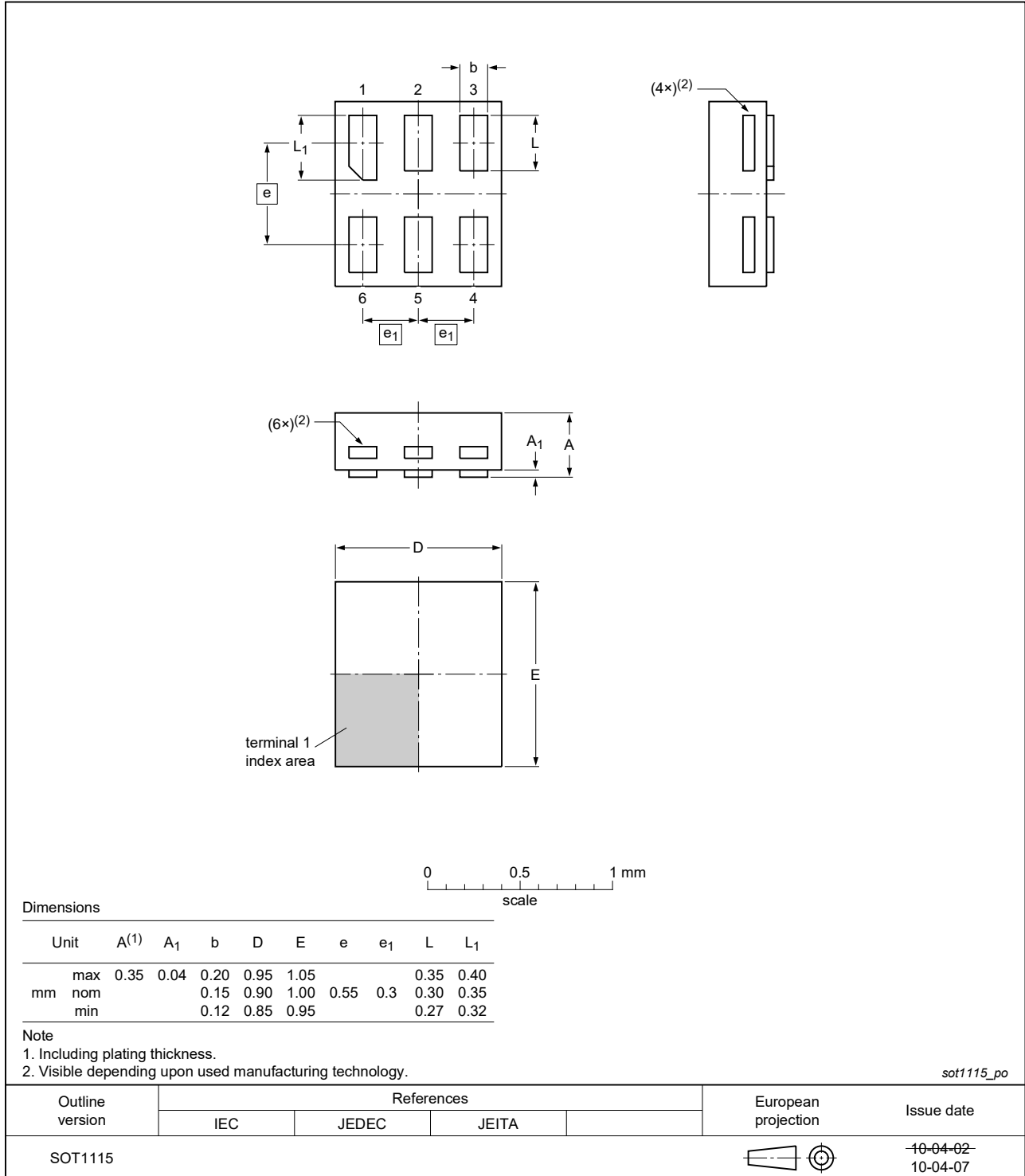

Fig. 28. Package outline SOT1115 (XSON6)

**XSON6: extremely thin small outline package; no leads;
6 terminals; body 1.0 x 1.0 x 0.35 mm**

SOT1202

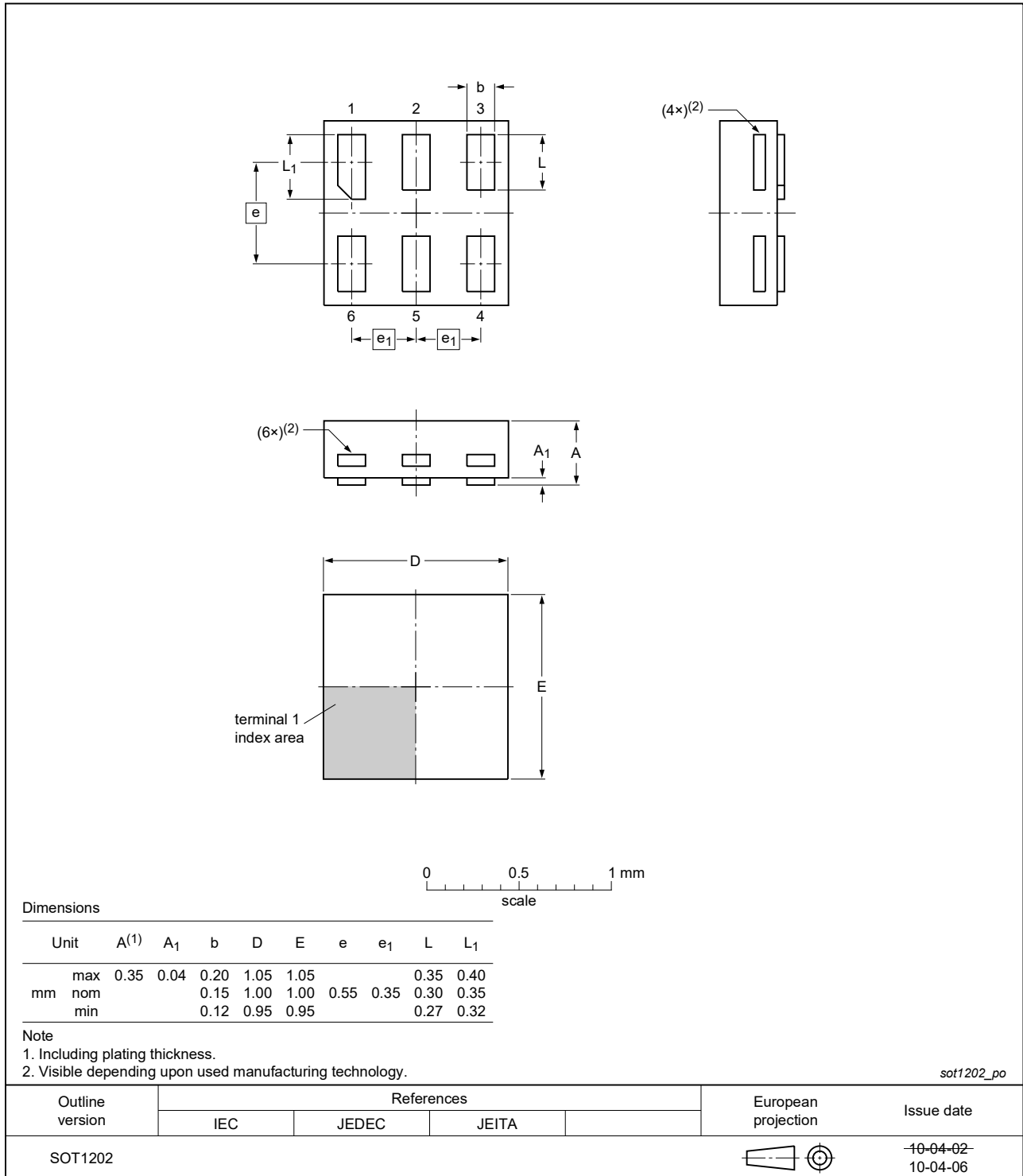

Fig. 29. Package outline SOT1202 (XSON6)

X2SON5: plastic thermal enhanced extremely thin small outline package; no leads; 5 terminals; body 0.8 x 0.8 x 0.32 mm

SOT1226-3

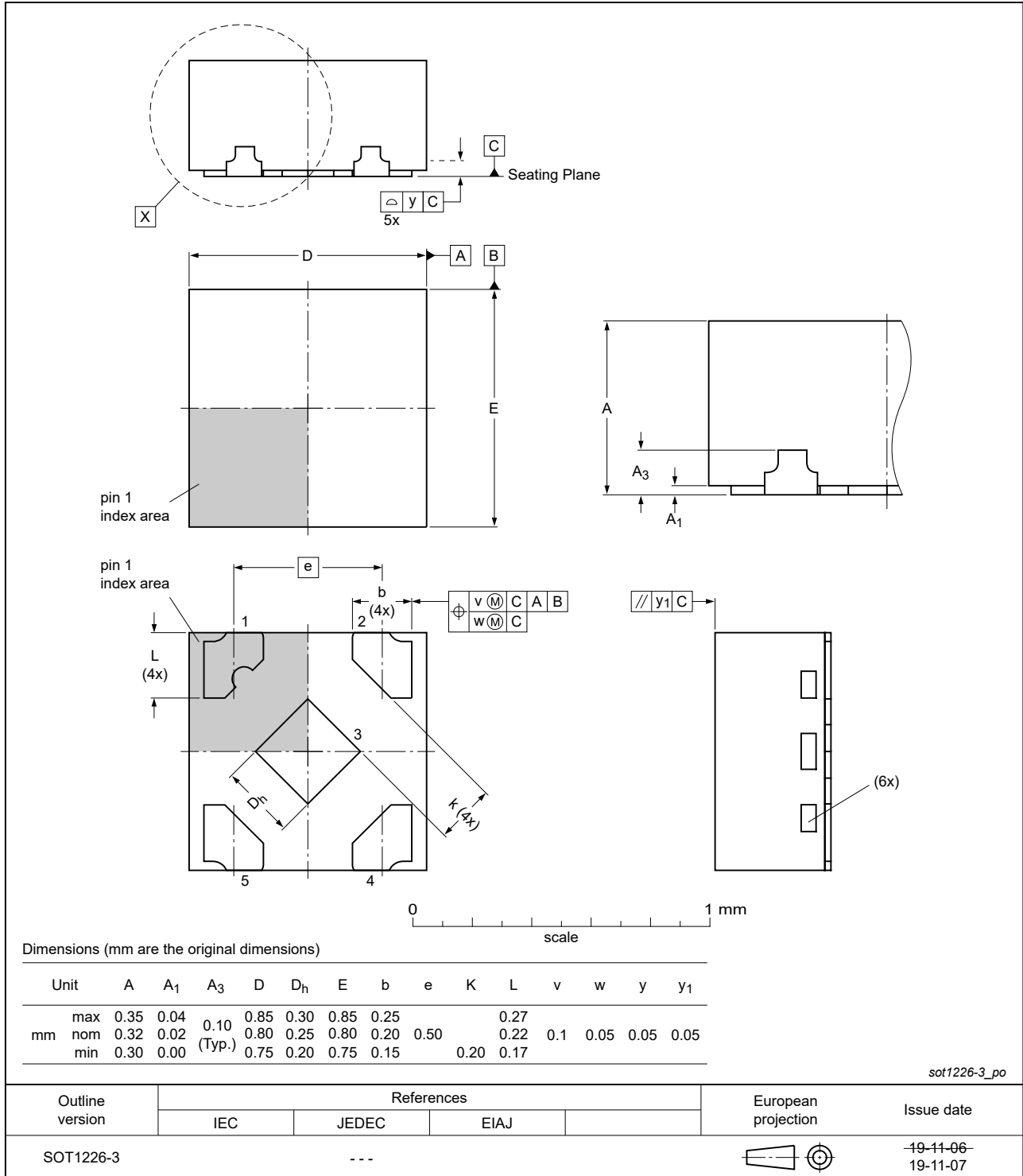

Fig. 30. Package outline SOT1226-3 (X2SON5)

13. Abbreviations

Table 13. Abbreviations

Acronym	Description
CMOS	Complementary Metal Oxide Semiconductor
DUT	Device Under Test
ESD	ElectroStatic Discharge
HBM	Human Body Model
MM	Machine Model
TTL	Transistor-Transistor Logic

14. Revision history

Table 14. Revision history

Document ID	Release date	Data sheet status	Change notice	Supersedes
74LVC1G384 v.9	20220816	Product data sheet	-	74LVC1G384 v.8
Modifications:	<ul style="list-style-type: none"> Package SOT1226 (X2SON5) has changed to SOT1226-3 (X2SON5). 			
74LVC1G384 v.8	20220208	Product data sheet	-	74LVC1G384 v.7
Modifications:	<ul style="list-style-type: none"> The format of this data sheet has been redesigned to comply with the identity guidelines of Nexperia. Legal texts have been adapted to the new company name where appropriate. Section 1 and Section 2 updated. Table 5: Derating values for P_{tot} total power dissipation updated. Fig. 25: Package outline drawing SOT353-1 (TSSOP5) has changed. Type number 74LVC1G384GF (SOT891/XSON6) removed. 			
74LVC1G384 v.7	20161207	Product data sheet	-	74LVC1G384 v.6
Modifications:	<ul style="list-style-type: none"> Table 7: The maximum limits for leakage current and supply current have changed. 			
74LVC1G384 v.6	20150903	Product data sheet	-	74LVC1G384 v.5
Modifications:	<ul style="list-style-type: none"> Added type number 74LVC1G384GX (SOT1226) 			
74LVC1G384 v.5	20150115	Product data sheet	-	74LVC1G384 v.4
Modifications:	<ul style="list-style-type: none"> SOT886 (XSON6) package outline drawing modified. 			
74LVC1G384 v.4	20111206	Product data sheet	-	74LVC1G384 v.3
Modifications:	<ul style="list-style-type: none"> Legal pages updated. 			
74LVC1G384 v.3	20101103	Product data sheet	-	74LVC1G384 v.2
74LVC1G384 v.2	20070829	Product data sheet	-	74LVC1G384 v.1
74LVC1G384 v.1	20040226	Product data sheet	-	-

15. Legal information

Data sheet status

Document status [1][2]	Product status [3]	Definition
Objective [short] data sheet	Development	This document contains data from the objective specification for product development.
Preliminary [short] data sheet	Qualification	This document contains data from the preliminary specification.
Product [short] data sheet	Production	This document contains the product specification.

- [1] Please consult the most recently issued document before initiating or completing a design.
- [2] The term 'short data sheet' is explained in section "Definitions".
- [3] The product status of device(s) described in this document may have changed since this document was published and may differ in case of multiple devices. The latest product status information is available on the internet at <https://www.nexperia.com>.

Definitions

Draft — The document is a draft version only. The content is still under internal review and subject to formal approval, which may result in modifications or additions. Nexperia does not give any representations or warranties as to the accuracy or completeness of information included herein and shall have no liability for the consequences of use of such information.

Short data sheet — A short data sheet is an extract from a full data sheet with the same product type number(s) and title. A short data sheet is intended for quick reference only and should not be relied upon to contain detailed and full information. For detailed and full information see the relevant full data sheet, which is available on request via the local Nexperia sales office. In case of any inconsistency or conflict with the short data sheet, the full data sheet shall prevail.

Product specification — The information and data provided in a Product data sheet shall define the specification of the product as agreed between Nexperia and its customer, unless Nexperia and customer have explicitly agreed otherwise in writing. In no event however, shall an agreement be valid in which the Nexperia product is deemed to offer functions and qualities beyond those described in the Product data sheet.

Disclaimers

Limited warranty and liability — Information in this document is believed to be accurate and reliable. However, Nexperia does not give any representations or warranties, expressed or implied, as to the accuracy or completeness of such information and shall have no liability for the consequences of use of such information. Nexperia takes no responsibility for the content in this document if provided by an information source outside of Nexperia.

In no event shall Nexperia be liable for any indirect, incidental, punitive, special or consequential damages (including - without limitation - lost profits, lost savings, business interruption, costs related to the removal or replacement of any products or rework charges) whether or not such damages are based on tort (including negligence), warranty, breach of contract or any other legal theory.

Notwithstanding any damages that customer might incur for any reason whatsoever, Nexperia's aggregate and cumulative liability towards customer for the products described herein shall be limited in accordance with the Terms and conditions of commercial sale of Nexperia.

Right to make changes — Nexperia reserves the right to make changes to information published in this document, including without limitation specifications and product descriptions, at any time and without notice. This document supersedes and replaces all information supplied prior to the publication hereof.

Suitability for use — Nexperia products are not designed, authorized or warranted to be suitable for use in life support, life-critical or safety-critical systems or equipment, nor in applications where failure or malfunction of an Nexperia product can reasonably be expected to result in personal

injury, death or severe property or environmental damage. Nexperia and its suppliers accept no liability for inclusion and/or use of Nexperia products in such equipment or applications and therefore such inclusion and/or use is at the customer's own risk.

Quick reference data — The Quick reference data is an extract of the product data given in the Limiting values and Characteristics sections of this document, and as such is not complete, exhaustive or legally binding.

Applications — Applications that are described herein for any of these products are for illustrative purposes only. Nexperia makes no representation or warranty that such applications will be suitable for the specified use without further testing or modification.

Customers are responsible for the design and operation of their applications and products using Nexperia products, and Nexperia accepts no liability for any assistance with applications or customer product design. It is customer's sole responsibility to determine whether the Nexperia product is suitable and fit for the customer's applications and products planned, as well as for the planned application and use of customer's third party customer(s). Customers should provide appropriate design and operating safeguards to minimize the risks associated with their applications and products.

Nexperia does not accept any liability related to any default, damage, costs or problem which is based on any weakness or default in the customer's applications or products, or the application or use by customer's third party customer(s). Customer is responsible for doing all necessary testing for the customer's applications and products using Nexperia products in order to avoid a default of the applications and the products or of the application or use by customer's third party customer(s). Nexperia does not accept any liability in this respect.

Limiting values — Stress above one or more limiting values (as defined in the Absolute Maximum Ratings System of IEC 60134) will cause permanent damage to the device. Limiting values are stress ratings only and (proper) operation of the device at these or any other conditions above those given in the Recommended operating conditions section (if present) or the Characteristics sections of this document is not warranted. Constant or repeated exposure to limiting values will permanently and irreversibly affect the quality and reliability of the device.

Terms and conditions of commercial sale — Nexperia products are sold subject to the general terms and conditions of commercial sale, as published at <http://www.nexperia.com/profile/terms>, unless otherwise agreed in a valid written individual agreement. In case an individual agreement is concluded only the terms and conditions of the respective agreement shall apply. Nexperia hereby expressly objects to applying the customer's general terms and conditions with regard to the purchase of Nexperia products by customer.

No offer to sell or license — Nothing in this document may be interpreted or construed as an offer to sell products that is open for acceptance or the grant, conveyance or implication of any license under any copyrights, patents or other industrial or intellectual property rights.

Export control — This document as well as the item(s) described herein may be subject to export control regulations. Export might require a prior authorization from competent authorities.

Non-automotive qualified products — Unless this data sheet expressly states that this specific Nexperia product is automotive qualified, the product is not suitable for automotive use. It is neither qualified nor tested in accordance with automotive testing or application requirements. Nexperia accepts no liability for inclusion and/or use of non-automotive qualified products in automotive equipment or applications.

In the event that customer uses the product for design-in and use in automotive applications to automotive specifications and standards, customer (a) shall use the product without Nexperia's warranty of the product for such automotive applications, use and specifications, and (b) whenever customer uses the product for automotive applications beyond Nexperia's specifications such use shall be solely at customer's own risk, and (c) customer fully indemnifies Nexperia for any liability, damages or failed product claims resulting from customer design and use of the product for automotive applications beyond Nexperia's standard warranty and Nexperia's product specifications.

Translations — A non-English (translated) version of a document is for reference only. The English version shall prevail in case of any discrepancy between the translated and English versions.

Trademarks

Notice: All referenced brands, product names, service names and trademarks are the property of their respective owners.

Contents

1. General description	1
2. Features and benefits	1
3. Ordering information	1
4. Marking	2
5. Functional diagram	2
6. Pinning information	2
6.1. Pinning.....	2
6.2. Pin description.....	3
7. Functional description	3
8. Limiting values	4
9. Recommended operating conditions	4
10. Static characteristics	5
10.1. Test circuits.....	5
10.2. ON resistance.....	6
10.3. ON resistance test circuit and graphs.....	7
11. Dynamic characteristics	9
11.1. Waveforms and test circuit.....	10
11.2. Additional dynamic characteristics.....	11
11.3. Test circuits.....	13
12. Package outline	15
13. Abbreviations	21
14. Revision history	21
15. Legal information	22

© Nexperia B.V. 2022. All rights reserved

For more information, please visit: <http://www.nexperia.com>

For sales office addresses, please send an email to: salesaddresses@nexperia.com

Date of release: 16 August 2022
