

Reference Only

Chip EMIFIL LC Combined Monolithic NFL15ST□□7X0J3□

Reference Specification

1. Scope

This reference specification applies to Chip EMIFIL LC Combined Monolithic Type NFL15ST Series.

2. Part Numbering

NF	L	15	ST	157	X	0J	3	D
Product ID	Structure	Dimension (L×W)	Features	Cut-off Frequency	Characteristics	Rated Voltage	Electrode	Packaging Code (D: Taping / B: Bulk)

3. Rating

Customer Part Number	MURATA Part Number	Cut-off Frequency [MHz]	Insertion Loss (I.L.)(dB)		DC Resistance [Ω]	Rated Current [mA(DC)]	Insulation Resistance [MΩ min.]	Rated Voltage [V(DC)]	Withstanding Voltage [V(DC)]
	NFL15ST157X0J3D NFL15ST157X0J3B	150	6 max. (0 to 150MHz)	25 min. (400 to 1000MHz)	20±30%	50	1000	6.3	18.9
	NFL15ST207X0J3D NFL15ST207X0J3B	200	6 max. (0 to 200MHz)	25 min. (600 to 1000MHz)	18±30%				
	NFL15ST307X0J3D NFL15ST307X0J3B	300	6 max. (0 to 300MHz)	25 min. (800 to 1000MHz)	17±30%				
	NFL15ST507X0J3D NFL15ST507X0J3B	500	6 max. (0 to 500MHz)	25 min. (1000MHz)	14±30%				

<Capacitance> NFL15ST157X0J3□: 22pF (typ.)
 NFL15ST207X0J3□: 17pF (typ.)
 NFL15ST307X0J3□: 12pF (typ.)
 NFL15ST507X0J3□: 7pF (typ.)

<Inductance> NFL15ST157X0J3□: 115nH (typ.)
 NFL15ST207X0J3□: 105nH (typ.)
 NFL15ST307X0J3□: 95nH (typ.)
 NFL15ST507X0J3□: 60nH (typ.)

- Operating Temperature: -40°C to +85°C
- Storage Temperature: -40°C to +85°C

4. Standard Testing Condition

< Unless otherwise specified >

Temperature: Ordinary Temp. / 15 °C to 35 °C
 Humidity: Ordinary Humidity / 25 %(RH) to 85 %(RH)

< In case of doubt >

Temperature: 20 °C ± 2 °C
 Humidity: 60 %(RH) to 70 %(RH)
 Atmospheric pressure: 86 kPa to 106 kPa

5. Style and Dimensions

(Top view)

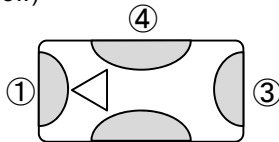

(Side View)

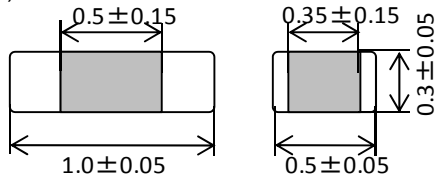

(Bottom View)

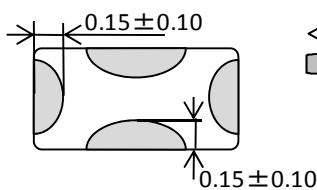

△ : Polarity Marking
 ■ : Electrode (in mm)

Equivalent Circuits

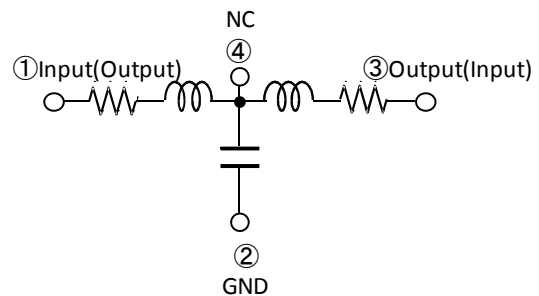

■ Unit Mass(Typical value)
 0.5mg

Reference Only

Spec. No. JENF243D-0009C-01

P 2 / 9

■ **NC (Non-Contact) Terminal**

Don't connect NC terminal with any signal lines/GND lines on the circuit board.

■ **Insertion Loss Characteristics (I.L.) (Typ.)** (50 Ω system)

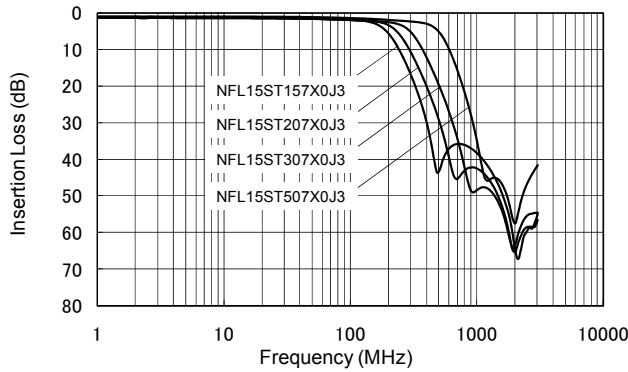

6. Marking

Polarity marking is on the upper surface of a product.

7. Electrical Performance

No.	Item	Specification	Test Method
7.1	Insertion Loss (I.L.)	Meet item 3.	<p>* Method of measurement based on MIL-STD-220 Insertion Loss = $20 \log (E_0 / E_1)$ E₀ : Level without FILTER (short) E₁ : Level with FILTER</p>
7.2	DC Resistance (Rdc)		Measured with 10mA max.
7.3	Insulation Resistance(I.R.)		Measured between terminal ①-③. (ref. Item5)
7.4	Withstanding Voltage	Products shall not be damaged.	<ul style="list-style-type: none"> • Voltage : Rated Voltage • Time : 1 minutes max. • Test Voltage : Rated Voltage × 300% • Time : 1 to 5s • Charge Current : 50 mA max.

8. Mechanical Performance

No.	Item	Specification	Test Method
8.1	Appearance and Dimensions	Meet item 5.	Visual Inspection and measured with Slide Calipers.
8.2	Solderability	Electrodes shall be at least 90% covered with new solder coating.	<ul style="list-style-type: none"> • Flux : Ethanol solution of rosin, 25(wt)% • Pre-heat : 150 ± 10°C, 60 to 90s • Solder : Sn-3.0Ag-0.5Cu • Solder Temperature : 240 ± 3°C • Immersion Time : 3±1 s • Immersion and emersion rates : 25mm / s

Reference Only

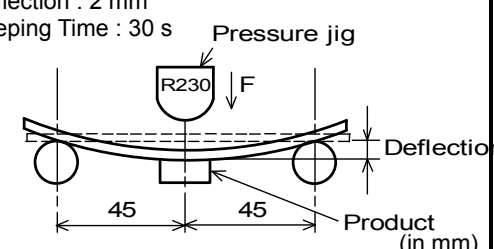
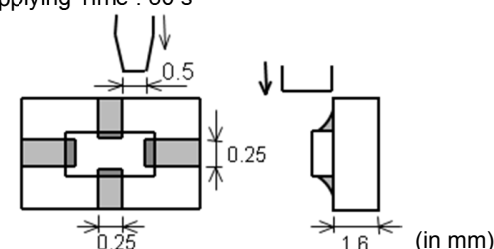
No.	Item	Specification	Test Method								
8.3	Resistance to soldering heat	Meet Table 1. <table border="1" style="margin-left: 20px; border-collapse: collapse;"> <caption>Table 1</caption> <tr> <td style="width: 50%;">Appearance</td> <td>No damaged</td> </tr> <tr> <td>Cap. Change</td> <td>Within $\pm 10\%$</td> </tr> <tr> <td>L Change</td> <td>Within $\pm 10\%$</td> </tr> <tr> <td>I.R.</td> <td>Meet item 3</td> </tr> </table>	Appearance	No damaged	Cap. Change	Within $\pm 10\%$	L Change	Within $\pm 10\%$	I.R.	Meet item 3	<ul style="list-style-type: none"> • Flux : Ethanol solution of rosin, 25(wt)% • Pre-heat : $150 \pm 10^\circ\text{C}$, 60 to 90s • Solder : Sn-3.0Ag-0.5Cu • Solder Temperature : $270 \pm 5^\circ\text{C}$ • Immersion Time : 10 ± 1 s • Immersion and emersion rates : 25mm / s • Then measured after exposure in the room condition for 24\pm2 hours.
Appearance	No damaged										
Cap. Change	Within $\pm 10\%$										
L Change	Within $\pm 10\%$										
I.R.	Meet item 3										
8.4	Bending Strength	Meet Table 1.	It shall be soldered on the glass-epoxy substrate (t = 1.0mm). <ul style="list-style-type: none"> • Deflection : 2 mm • Keeping Time : 30 s 								
8.5	Drop	Products shall be no failure after tested.	It shall be dropped on concrete or steel board. <ul style="list-style-type: none"> • Method : Free fall • Height : 1m • Attitude from which the product is dropped : 3 directions • The Number of Time : 3 times for each direction (Total 9 times) 								
8.6	Bonding Strength	The electrodes shall be no failure after tested.	It shall be soldered on the glass-epoxy substrate. <ul style="list-style-type: none"> • Applying Force (F) : 5 N • Applying Time : 30 s 								
8.7	Vibration	Meet Table 1.	It shall be soldered on the glass-epoxy substrate. <ul style="list-style-type: none"> • Oscillation Frequency : 10 to 2000 to 10Hz for 15 min • Total amplitude 3.0mm or Acceleration amplitude 196m/s² whichever is smaller. • Time: A period of 2 hours in each of 3 mutually perpendicular directions. (Total 6 hours) 								

9. Environment Performance

It shall be soldered on the glass-epoxy substrate.

No.	Item	Specification	Test Method
9.1	Temperature Cycling	Meet Table 1.	<ul style="list-style-type: none"> • 1 Cycle <ul style="list-style-type: none"> 1 step : $-40 \pm 0_3^\circ\text{C} / 30 \pm 3_0$ min 2 step : Room Temperature / within 3 min 3 step : $+85 \pm 3_0^\circ\text{C} / 30 \pm 3_0$ min 4 step : Room Temperature / within 3 min • Total of 100 cycles • Then measured after exposure in the room condition for 24\pm2 hours.
9.2	Humidity		<ul style="list-style-type: none"> • Temperature : $40 \pm 2^\circ\text{C}$ • Humidity : 90 to 95%(RH) • Time : 1000$\pm 24_0$ hours • Then measured after exposure in the room condition for 24\pm2 hours.

Reference Only

Spec. No. JENF243D-0009C-01

P 4 / 9

No.	Item	Specification	Test Method
9.3	Heat Life	Meet Table 1.	<ul style="list-style-type: none"> • Temperature : 85 ± 2 °C • Test Voltage : Rated Voltage \times 200% • Charge Current : 50 mA max. • Time : $1000 \pm 48_0$ hours • Then measured after exposure in the room condition for 24 ± 2 hours.

10. Specification of Packaging

10.1. Appearance and Dimensions (8mm-wide paper tape)

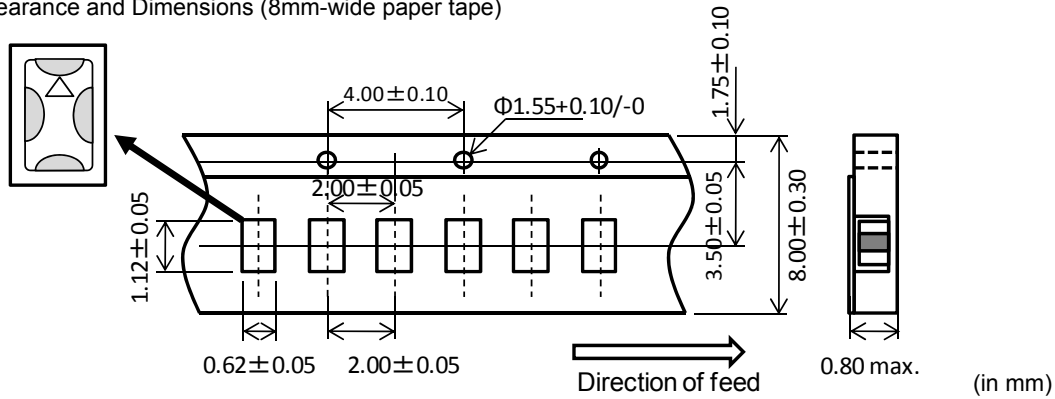

10.2. Specification of Taping

(1) Packing quantity (standard quantity)

10,000 pcs. / reel

(2) Packing Method

Products shall be packaged in the cavity of the base tape and sealed by cover tape.

(3) Sprocket Hole

The sprocket holes are to the right as the tape is pulled toward the user.

(4) Base tape and Cover tape

The base tape and cover tape have no spliced point.

(5) Cavity

There shall not be burr in the cavity.

(6) Missing components number

Missing components number within 0.1% of the number per reel or 1 pc., whichever is greater, and are not continuous. The specified quantity per reel is kept.

10.3. Pull Strength of Cover tape

Cover tape	5N min.
------------	---------

10.4. Peeling off force of Cover tape

0.1N to 0.6N (minimum value is typical)

Speed of Peeling off : 300 mm / min

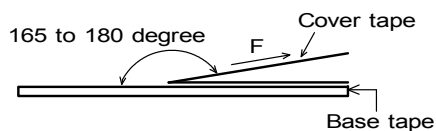

10.5. Dimensions of Leader-tape, Trailer and Reel

There shall be leader-tape (cover tape and empty tape) and trailer-tape (empty tape) as follows.

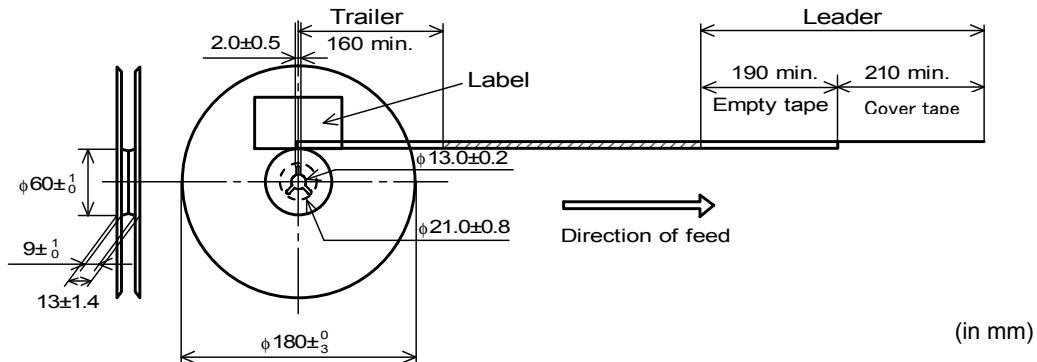

Reference Only

12.2. Connection to NC(Non-Contact) Terminal

Please don't connect NC terminal with any signal lines or GND lines on the circuit board.
When NC terminal is connected to GND, it causes fuming or partial dispersion because input or output signal terminals short-circuit to ground.

12.3. Limitation of Applications

Please contact us before using our products for the applications listed below which require especially high reliability for the prevention of defects which might directly cause damage to the third party's life, body or property.

- (1) Aircraft equipment (2) Aerospace equipment (3) Undersea equipment (4) Power plant control equipment
- (5) Medical equipment (6) Transportation equipment(automobiles, trains, ships, etc.) (7) Traffic signal equipment
- (8) Disaster prevention / crime prevention equipment (9) Data-processing equipment
- (10) Applications of similar complexity or with reliability requirements comparable to the applications listed in the above

13. Notice

Products can only be soldered with reflow.
This product is designed for solder mounting.
Please consult us in advance for applying other mounting method such as conductive adhesive.

13.1. Flux and Solder

Flux	Use rosin-based flux, Do not use highly acidic flux (with chlorine content exceeding 0.2(wt)%). Do not use water-soluble flux.
Solder	Use Sn-3.0Ag-0.5Cu solder

Other flux (except above) Please contact us for details, then use.

13.2. Note for Assembling

< Thermal Shock >

Pre-heating should be in such a way that the temperature difference between solder and products surface is limited to 100°C max. Also cooling into solvent after soldering should be in such a way that the temperature difference is limited to 100°C max.

<NC (Non-Contact) Terminal>

Please solder the NC terminal on floated pattern, in order to secure the fixing strength of the part and to prevent displacement of the part during reflow soldering.

13.3. Attention Regarding P.C.B. Bending

The following shall be considered when designing P.C.B.'s and laying out products.

- (1) P.C.B. shall be designed so that products are not subject to the mechanical stress for board warpage.

[Products direction]

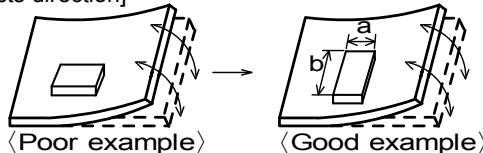

Products shall be located in the sideways direction (Length:a< b) to the mechanical stress.

- (2) Components location on P.C.B. separation.

It is effective to implement the following measures, to reduce stress in separating the board.

It is best to implement all of the following three measures; however, implement as many measures as possible to reduce stress.

Contents of Measures	Stress Level
(1) Turn the mounting direction of the component parallel to the board separation surface.	A > D *1
(2) Add slits in the board separation part.	A > B
(3) Keep the mounting position of the component away from the board separation surface.	A > C

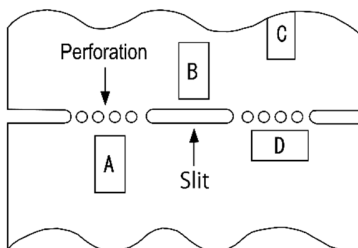

*1 A > D is valid when stress is added vertically to the perforation as with Hand Separation. If a Cutting Disc is used, stress will be diagonal to the PCB, therefore A > D is invalid.

Reference Only

(3) Mounting Components Near Screw Holes

When a component is mounted near a screw hole, it may be affected by the board deflection that occurs during the tightening of the screw. Mount the component in a position as far away from the screw holes as possible.

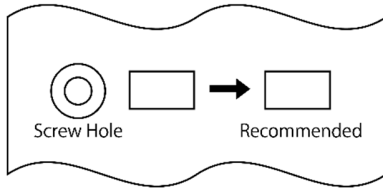

13.4. Pre-heating Temperature

Soldering shall be handled so that the difference between pre-heating temperature and solder temperature shall be limited to 100°C max. to avoid the heat stress for the products.

13.5. Reflow Soldering

1) Soldering paste printing for reflow

- Standard thickness of solder paste: 100µm to 150µm.
- Use the solder paste printing pattern of the right pattern.
- For the resist and copper foil pattern, use standard land dimensions.

- Standard printing pattern of solder paste.

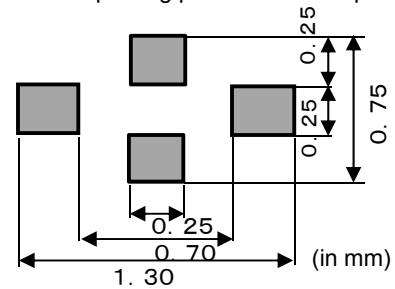

2) Soldering Conditions

Standard soldering profile and the limit soldering profile is as follows.

The excessive limit soldering conditions may cause leaching of the electrode and / or resulting in the deterioration of product quality.

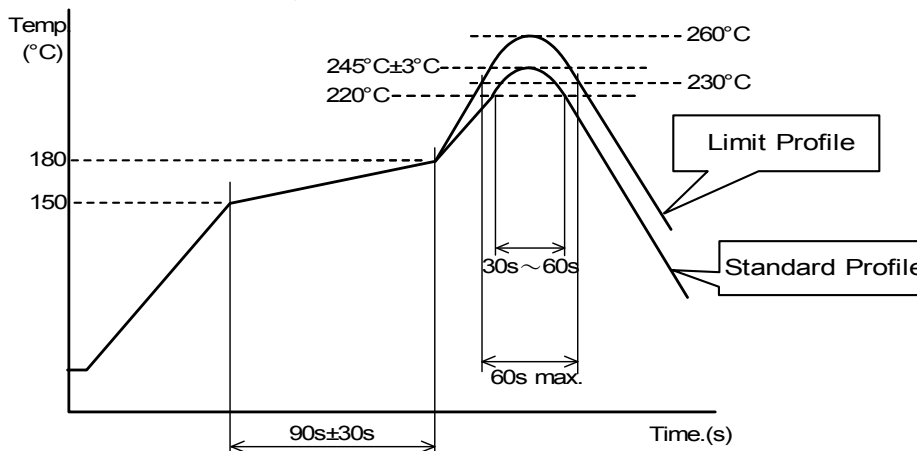

	Standard Profile	Limit Profile
Pre-heating	150°C ~ 180°C , 90s ± 30s	
Heating	above 220°C , 30s ~ 60s	above 230°C , 60s max.
Peak temperature	245°C ± 3°C	260°C , 10s
Cycle of reflow	2 times	2 times

13.6. Reworking with Soldering iron

The following conditions shall be strictly followed when using a soldering iron.

- Pre-heating : 150°C, 1 min
- Tip temperature : 350°C max.
- Soldering time : 3(+1,-0) s
- Soldering iron output : 30W max.
- Tip diameter : φ 3mm max.
- Times : 2times max.

Note: Do not directly touch the products with the tip of the soldering iron in order to prevent the crack on the ceramic material due to the thermal shock.

Reference Only

Spec. No. JENF243D-0009C-01

P 8/9

13.7. Solder Volume

Solder shall be used not to be exceeded as shown below.

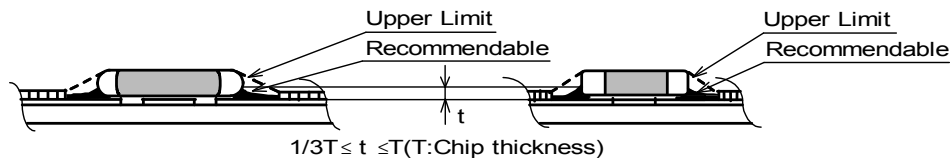

Accordingly increasing the solder volume, the mechanical stress to product is also increased. Excessive solder volume may cause the failure of mechanical or electrical performance.

13.8. Cleaning Conditions

Products shall be cleaned on the following conditions.

- (1) Cleaning temperature shall be limited to 60°C max. (40°C max. for Isopropyl alcohol (IPA))
- (2) Ultrasonic cleaning shall comply with the following conditions, with avoiding the resonance phenomenon at the mounted products and P.C.B.
 - Power: 20W / l max.
 - Frequency: 28kHz to 40kHz
 - Time: 5 minutes max.
- (3) Cleaner
 1. Cleaner
 - Isopropyl alcohol (IPA)
 2. Aqueous agent
 - PINE ALPHA ST-100S
- (4) There shall be no residual flux and residual cleaner after cleaning.

In the case of using aqueous agent, products shall be dried completely after rinse with de-ionized water in order to remove the cleaner.
- (5) Other cleaning
Please contact us.

13.9. Operating Environment

Do not use this product under the following environmental conditions, on deterioration of the performance, such as insulation resistance may result from the use.

- (1) in the corrodible atmosphere (acidic gases, alkaline gases, chlorine, sulfur gases, organic gases and etc.)
- (2) in the atmosphere where liquid such as organic solvent, may splash on the products.
- (3) in the atmosphere where the temperature / humidity changes rapidly and it is easy to dew.

13.10. Resin coating

The capacitance and inductance value may change and/or it may affect on the product's performance due to high cure-stress of resin to be used for coating / molding products. So please pay your careful attention when you select resin. In prior to use, please make the reliability evaluation with the product mounted in your application set.

13.11. Handling of a substrate

After mounting products on a substrate, do not apply any stress to the product caused by bending or twisting to the substrate when cropping the substrate, inserting and removing a connector from the substrate or tightening screw to the substrate.

Excessive mechanical stress may cause cracking in the product.

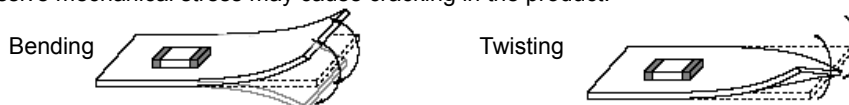

13.12. Storage condition

(1) Storage period

Use the products within 12 months after delivered.
Solderability should be checked if this period is exceeded.

(2) Storage environment condition

· Products should be stored in the warehouse on the following conditions.

Temperature : -10 to +40°C
Humidity : 15 to 85% relative humidity
No rapid change on temperature and humidity

- Don't keep products in corrosive gases such as sulfur, chlorine gas or acid, or it may cause oxidization of electrode, resulting in poor solderability.
- Products should be stored on the palette for the prevention of the influence from humidity, dust and so on.
- Products should be stored in the warehouse without heat shock, vibration, direct sunlight and so on.
- Products should be stored under the airtight packaged condition.

(3) Delivery

Care should be taken when transporting or handling product to avoid excessive vibration or mechanical shock.

Reference Only

Spec. No. JENF243D-0009C-01

P 9/ 9

14.  **Notes**

- (1) Please make sure that your product has been evaluated in view of your specifications with our product being mounted to your product.
- (2) You are requested not to use our product deviating from the reference specifications.
- (3) The contents of this reference specification are subject to change without advance notice. Please approve our product specifications or transact the approval sheet for product specifications before ordering.