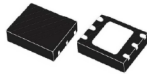


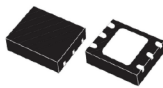
## High PSRR, low drop linear regulator IC



SO-8



DFN6 (2x2)



DFN6 (3x3)

### Features

- Input voltage from 2.5 V to 18 V
- 20 V AMR
- Any fixed output voltages, from 1.2 V to 12 V in 100 mV steps (from 1.2 V to 6.6 V in 50 mV steps) available on request
- Adjustable version from 1.18 V to  $V_{IN} - V_{DROP(MAX)}$
- Guaranteed output current 1.2 A
- Typical dropout 350 mV @ 1.2 A
- Undervoltage lockout
- Enable function
- Internal thermal, current and power limitation
- High PSRR: 87 dB @ 120 Hz, 75 dB @ 1 kHz
- Operating temperature range: -40 °C to 125 °C
- Packages SO-8 batwing plastic micropackage, DFN6 (3x3) and DFN6 (2x2)

### Applications

- Consumer
- Industrial
- SMPS
- Point-of-load
- DC-DC post-regulation

Maturity status link

LDL212

### Description

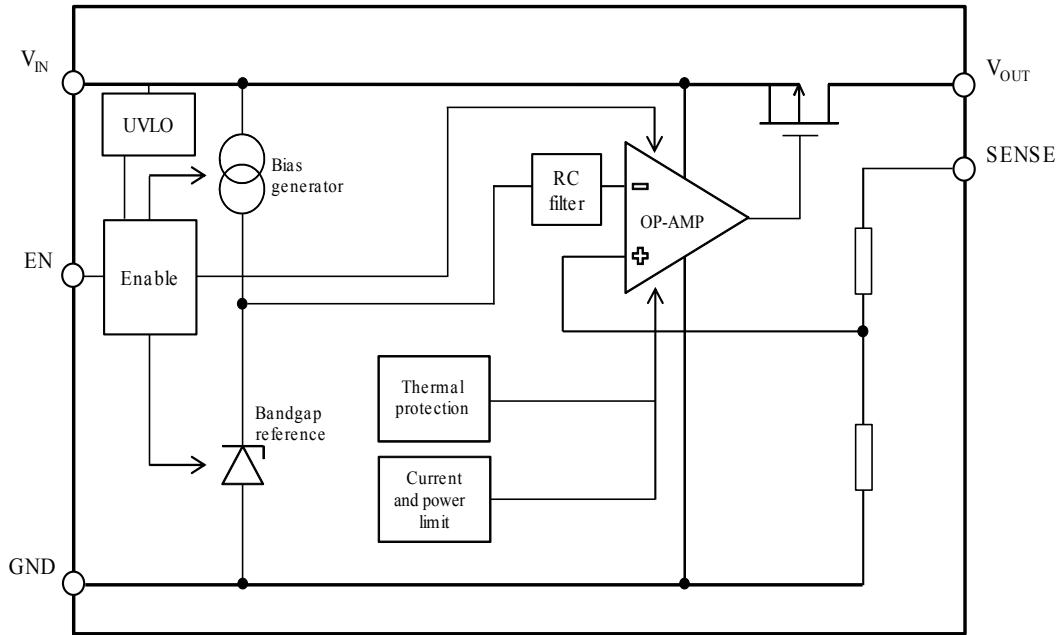
The [LDL212](#) provides 1.2 A of maximum current from an input voltage range from 2.5 V to 18 V, with a typical dropout voltage of 350 mV @ 1.2 A.

The high power supply rejection ratio of 87 dB at 120 Hz, and more than 40 dB at 100 kHz, makes the [LDL212](#) suitable for direct regulation in SMPS and secondary linear regulation in DC-DC converters. The [LDL212](#) goes to shutdown mode due to the enable logic control function, reducing the total current consumption.

The device also includes the current limit, SOA and thermal protections.

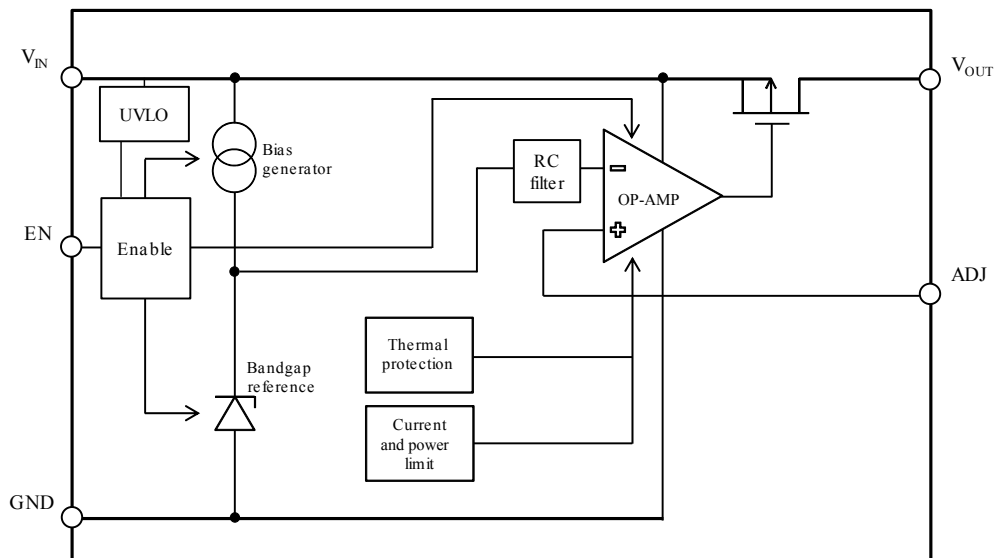
# 1 Block diagram

Figure 1. Block diagram (fixed)



GIPD251120151438MT

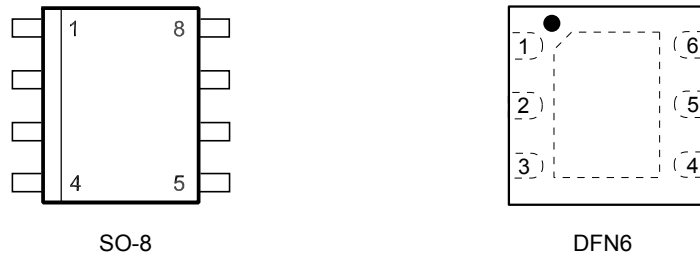
Figure 2. Block diagram (adjustable)



GIPD251120151438bMT

## 2 Pin configuration

Figure 3. Pin configuration (top view)



GIPD261120151015MT

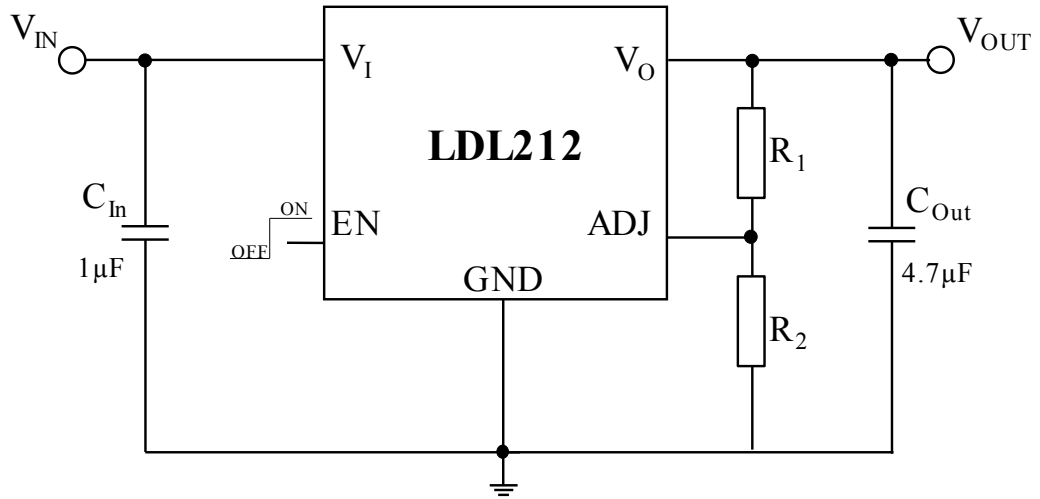
Table 1. Pin description

Pin name	Pin number (SO-8)	Pin number (DFN6)	Description
$V_{IN}$	4	4	Input voltage
$V_{OUT}$	1	3	Output voltage
GND	2, 3, 6, 7	1	Ground
ADJ/sense	8	2	Feedback pin for adjustable version / $V_{OUT}$ sense on fixed version
EN	5	6	Enable pin. The device is in off-state when this pin is pulled low
NC	-	5	Not connected
GND	-	exposed pad	Exposed pad must be connected to GND

1. The sense pin on the fixed version must be connected to  $V_{OUT}$  for proper operation.

### 3 Typical application

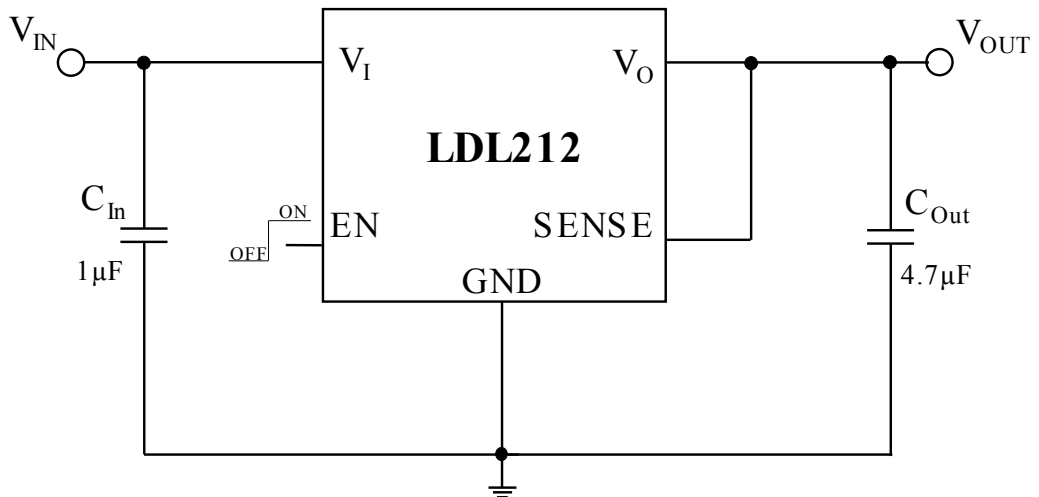
Figure 4. Typical application circuit (adjustable version)



Adjustable version

GIPD011220151346MT

Figure 5. Typical application circuit (fixed version)



Fixed version

GIPD011220151347MT

Note:  $R_1$  and  $R_2$  are calculated according to the following formula:  $R_1 = R_2 \times (V_{OUT}/V_{ADJ} - 1)$ . The output voltage of the adjustable version can be set from 1.18 V to  $V_{IN} - V_{DROPMAX}$ , where  $V_{DROPMAX}$  is the maximum dropout voltage, as defined in Table 4. Electrical characteristics.

## 4 Maximum ratings

**Table 2. Absolute maximum ratings**

Symbol	Parameter	Value	Unit
$V_{IN}$	DC input voltage	- 0.3 to 20	V
$V_{OUT}$	DC output voltage	- 0.3 to $V_{IN} + 0.3$	V
$V_{EN}$	Enable input voltage	- 0.3 to $V_{IN} + 0.3$	V
$V_{SENSE}$	Output sense pin voltage	- 0.3 to $V_{IN} + 0.3$	V
$V_{ADJ}$	ADJ pin voltage	- 0.3 to 2	V
$I_{OUT}$	Output current	Internally limited	mA
$P_D$	Power dissipation	Internally limited	mW
$T_{STG}$	Storage temperature range	- 55 to 150	°C
$T_{OP}$	Operating junction temperature range	- 40 to 125	°C

*Note:* Absolute maximum ratings are those values beyond which damage to the device may occur. Functional operation under these conditions is not implied.

**Table 3. Thermal data**

Symbol	Parameter	Value	Unit
SO-8 batwing plastic micropackage	Thermal resistance junction-to-case	20	°C/W
	Thermal resistance junction-to-ambient	55	
DFN6 (2x2)	Thermal resistance junction-to-case	15	
	Thermal resistance junction-to-ambient	65	
DFN6 (3x3)	Thermal resistance junction-to-case	10	
	Thermal resistance junction-to-ambient	55	

## 5 Electrical characteristics

$T_J = 25\text{ }^\circ\text{C}$ ,  $V_{IN} = V_{OUT(NOM)} + 1\text{ V}$ ,  $C_{IN} = 1\text{ }\mu\text{F}$ ,  $C_{OUT} = 4.7\text{ }\mu\text{F}$ ,  $I_{OUT} = 10\text{ mA}$ ,  $V_{EN} = V_{IN}$ , unless otherwise specified. ( For  $V_{OUT(NOM)} \leq 1.5\text{ V}$ ,  $V_{IN} = 2.7\text{ V}$ .)

**Table 4. Electrical characteristics**

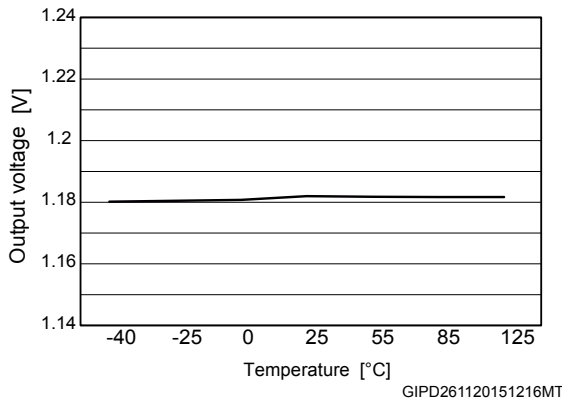
Symbol	Parameter	Test conditions	Min.	Typ.	Max.	Unit
$V_{IN}$	Operating input voltage		2.5		18	V
$V_{UVLO}$	Turn-on threshold			2.3	2.4	V
	Hysteresis			200		mV
$V_{OUT}$	$V_{OUT}$ accuracy	$I_{OUT} = 10\text{ mA}$	-2		2	%
		$T_J = 25\text{ }^\circ\text{C}$				
		$I_{OUT} = 10\text{ mA}$	-3		3	%
		$-40\text{ }^\circ\text{C} < T_J < 125\text{ }^\circ\text{C}$				
$V_{ADJ}$	Adjustable pin voltage	$V_{IN} = 2.5\text{ V}$ , $I_{OUT} = 10\text{ mA}$		1.18		V
		$T_J = 25\text{ }^\circ\text{C}$	-2		+2	%
		$V_{IN} = 2.5\text{ V}$ , $I_{OUT} = 10\text{ mA}$	-3		+3	%
		$-40\text{ }^\circ\text{C} < T_J < 125\text{ }^\circ\text{C}$				
$I_{ADJ}$	Adjustable pin current	$V_{IN} = 2.5\text{ V}$ , $I_{OUT} = 10\text{ mA}$		20		nA
$\Delta V_{OUT}$	Line regulation	$V_{OUT} + 1\text{ V} \leq V_{IN} \leq 18\text{ V}$ , $I_{OUT} = 10\text{ mA}$		0.002	0.01	%/V
$\Delta V_{OUT}$	Load regulation	$I_{OUT} = 10\text{ mA}$ to 1.2 A		0.0001	0.0005	%/mA
$V_{DROPO}$	Dropout voltage <sup>(1)</sup>	$I_{OUT} = 1.2\text{ A}$ , $V_{OUT} > 3\text{ V}$		350	600	mV
	Dropout voltage for SO-8 <sup>(1)</sup>	$-40\text{ }^\circ\text{C} < T_J < 125\text{ }^\circ\text{C}$			700	
eN	Output noise voltage	10 Hz to 100 kHz, $I_{OUT} = 100\text{ mA}$		60		$\mu\text{V}_{RMS}/V_{OUT}$
SVR	Supply voltage rejection	$V_{IN} = V_{OUT(NOM)} + 1\text{ V} \pm V_{RIPPLE}$		87		dB
		$V_{RIPPLE} = 0.5\text{ V}$ , $f = 120\text{ Hz}$				
		$V_{IN} = V_{OUT(NOM)} + 1\text{ V} \pm V_{RIPPLE}$		75		
		$V_{RIPPLE} = 0.5\text{ V}$ , $f = 1\text{ kHz}$				
		$V_{IN} = V_{OUT(NOM)} + 1\text{ V} \pm V_{RIPPLE}$		50		
$V_{RIPPLE} = 0.5\text{ V}$ , $f = 100\text{ kHz}$						
$I_Q$	Quiescent current	$I_{OUT} = 0\text{ mA}$ to 1.2 A		250	380	$\mu\text{A}$
		$-40\text{ }^\circ\text{C} < T_J < 125\text{ }^\circ\text{C}$				
		$V_{IN}$ input current in OFF mode		0.3	1.5	
		$V_{EN} = \text{GND}$ , $V_{IN} = 18\text{ V}$				
$I_{SC}$	Short-circuit current	$R_L = 0$	1.5	2		A
$V_{EN}$	Enable input logic low	$V_{IN} = 2.5\text{ V}$ to 18 V			0.4	V
	Enable input logic high	$-40\text{ }^\circ\text{C} < T_J < 85\text{ }^\circ\text{C}$				
		$V_{IN} = 2.5\text{ V}$ to 18 V	1.2			

Symbol	Parameter	Test conditions	Min.	Typ.	Max.	Unit
$V_{EN}$		$-40\text{ °C} < T_J < 85\text{ °C}$				V
$I_{EN}$	Enable input current			1.5		$\mu\text{A}$
		$V_{EN} = V_{IN}, V_{IN} = 18\text{ V}$		16	20	
$T_{ON}$	Turn-on time <sup>(2)</sup>			120		$\mu\text{s}$
$T_{SHDN}$	Thermal shutdown			175		$^{\circ}\text{C}$
	Hysteresis			25		

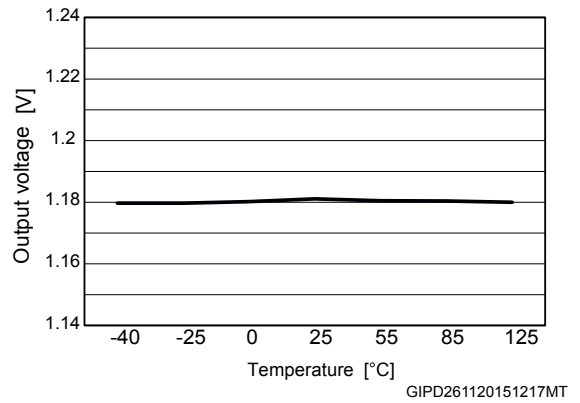
1. Dropout voltage is the input-to-output voltage difference at which the output voltage is 100 mV below its nominal value. This specification is not valid for output voltages below 2.2 V.
2. Turn-on time is the time measured between the enable input just exceeding  $V_{EN}$  high value and the output voltage just reaching 95% of its nominal value.

## 6 Typical performance characteristics

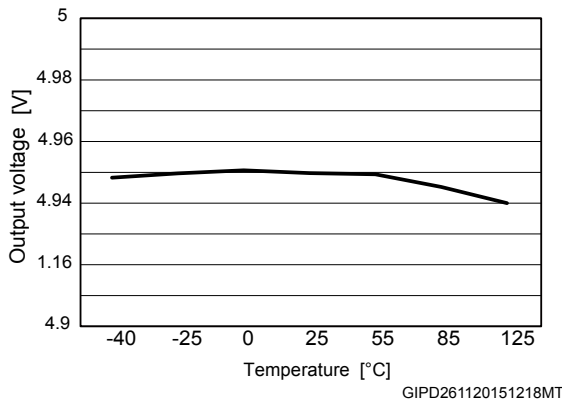
**Figure 6. Output voltage vs. temperature**  
 ( $V_{IN} = 2.5\text{ V}$ ,  $V_{OUT} = V_{ADJ}$ ,  $I_{OUT} = 0\text{ mA}$ )



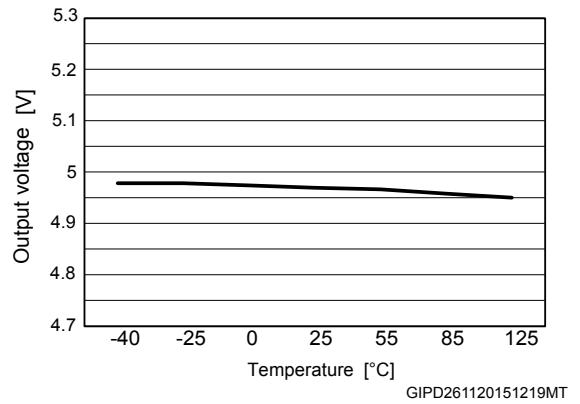
**Figure 7. Output voltage vs. temperature**  
 ( $V_{IN} = 2.5\text{ V}$ ,  $V_{OUT} = V_{ADJ}$ ,  $I_{OUT} = 1200\text{ mA}$ )



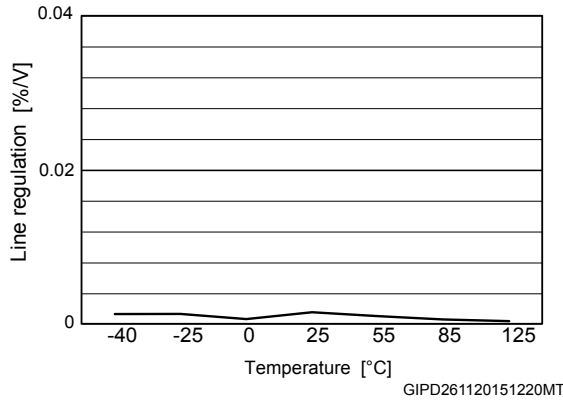
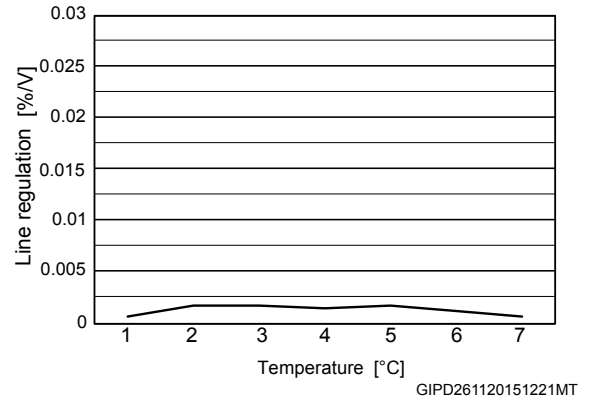
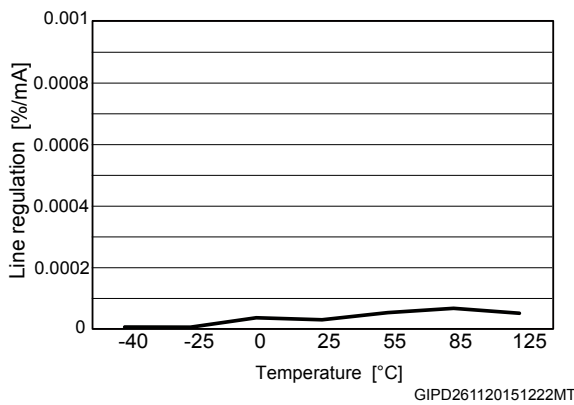
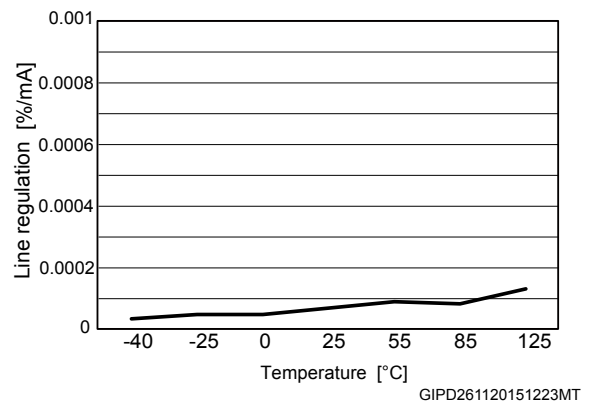
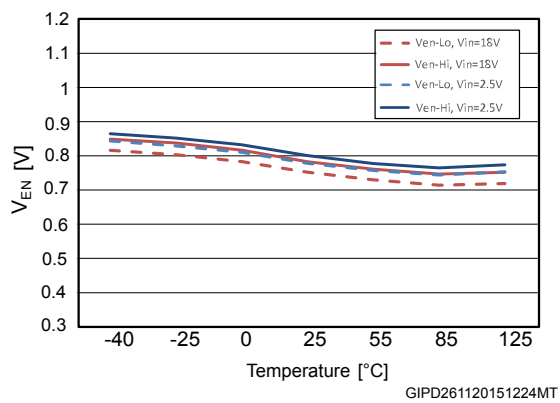
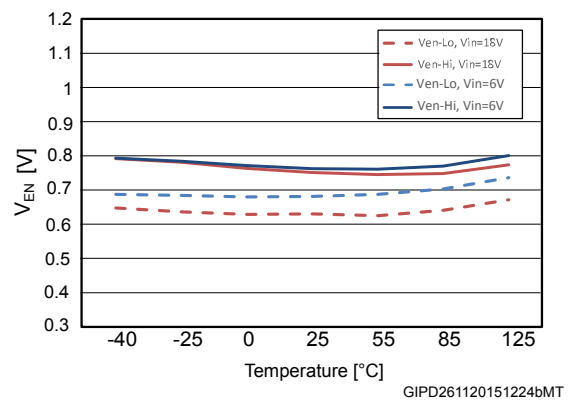
**Figure 8. Output voltage vs. temperature** ( $V_{IN} = 6\text{ V}$ ,  
 $V_{OUT} = 5\text{ V}$ ,  $I_{OUT} = 10\text{ mA}$ )

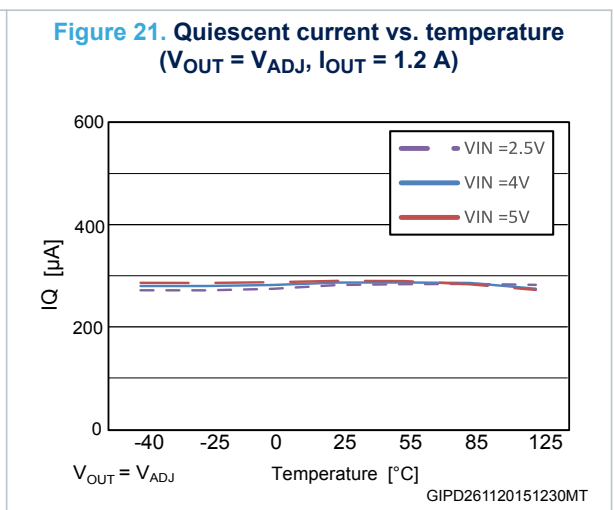
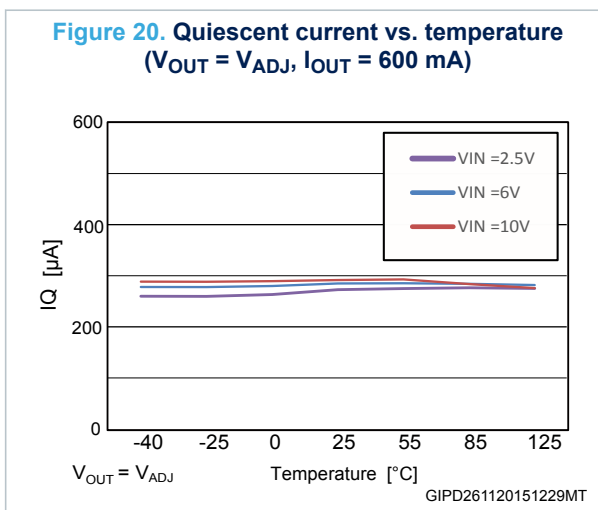
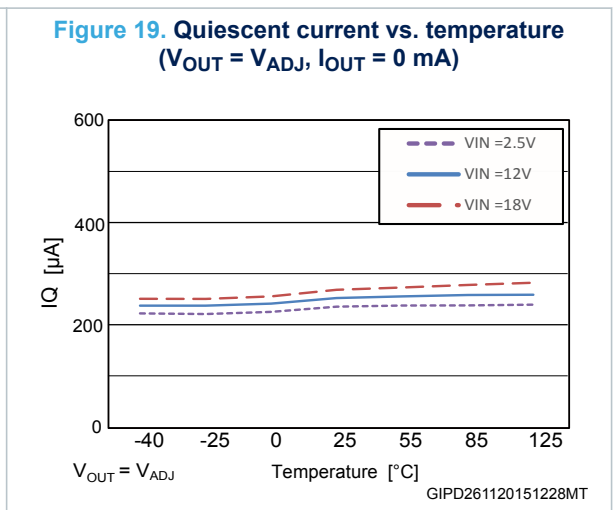
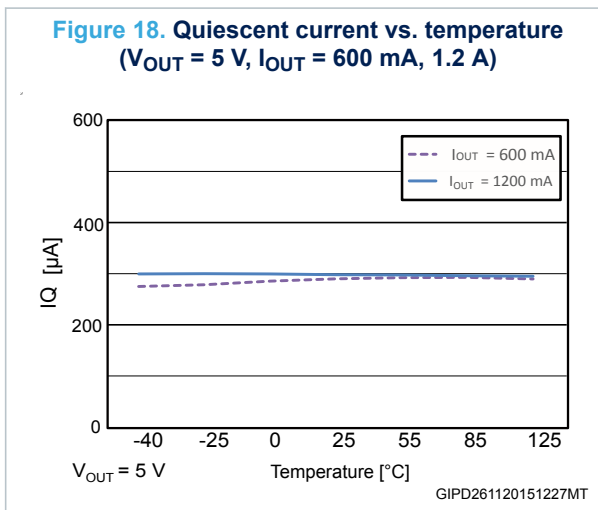
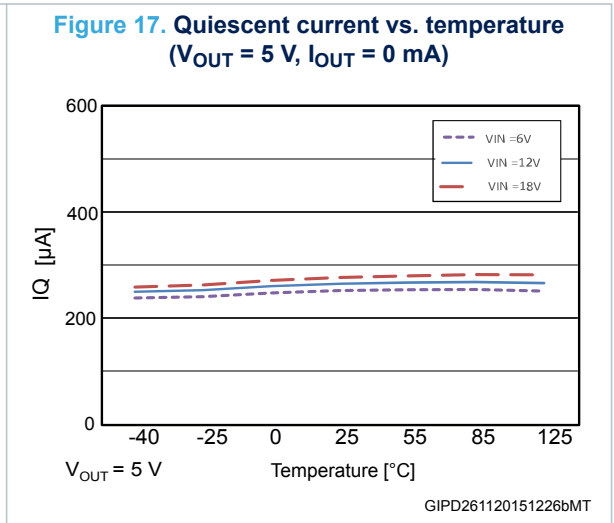
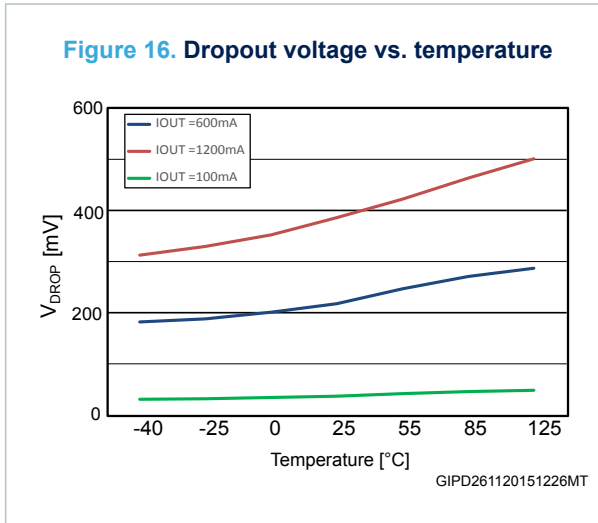


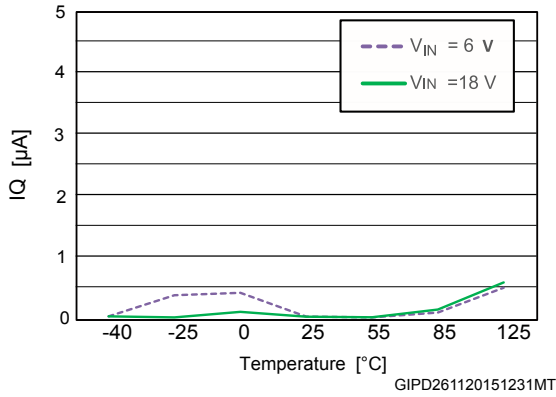
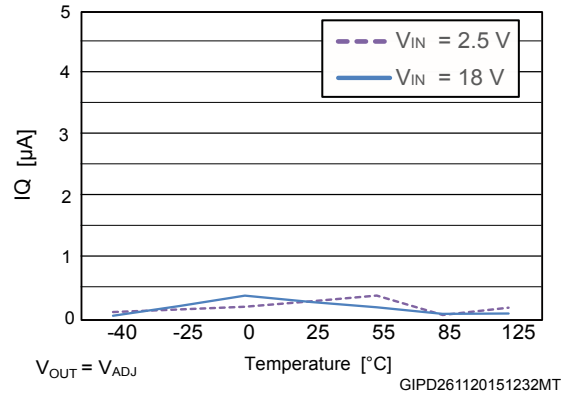
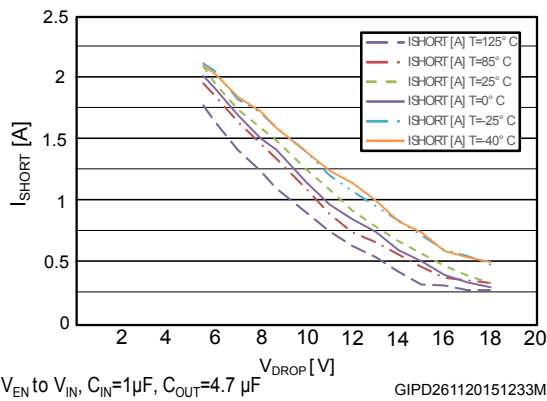
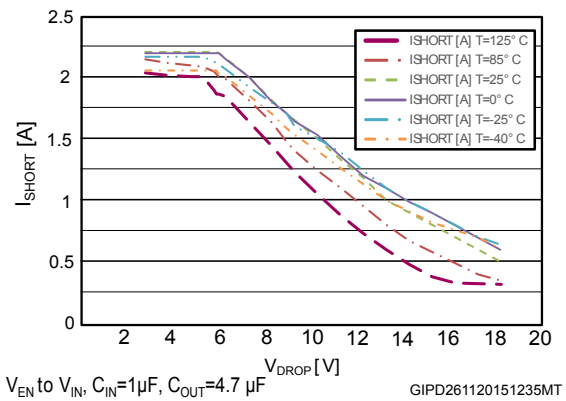
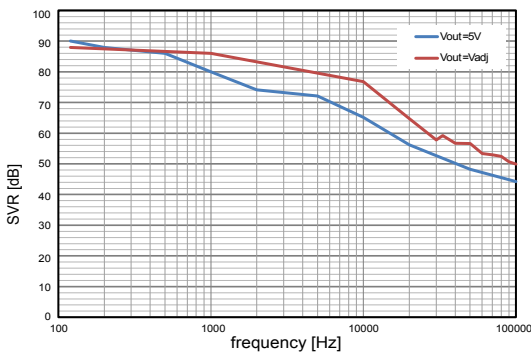
**Figure 9. Output voltage vs. temperature** ( $V_{IN} = 6\text{ V}$ ,  
 $V_{OUT} = 5\text{ V}$ ,  $I_{OUT} = 1200\text{ mA}$ )





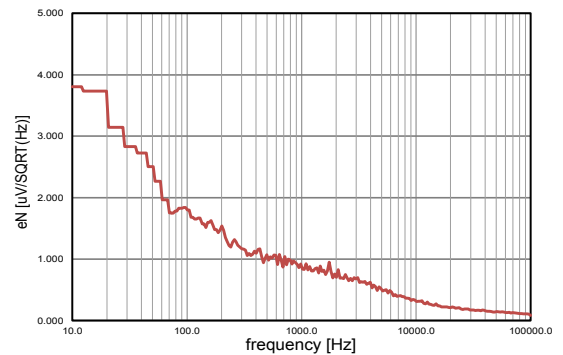
**Figure 10. Line regulation vs. temperature ( $V_{IN} = 6$  to 18 V,  $V_{OUT} = 5$  V,  $I_{OUT} = 10$  mA)**

**Figure 11. Line regulation vs. temperature ( $V_{IN} = 2.5$  to 18 V,  $V_{OUT} = V_{ADJ}$ ,  $I_{OUT} = 10$  mA)**

**Figure 12. Load regulation vs. temperature ( $V_{IN} = 6$  V,  $V_{OUT} = 5$  V,  $I_{OUT} = 10$  to 1200 mA)**

**Figure 13. Load regulation vs. temperature ( $V_{IN} = 2.5$  V,  $V_{OUT} = V_{ADJ}$ ,  $I_{OUT} = 0$  to 1200 mA)**

**Figure 14. Enable thresholds vs. temperature ( $V_{OUT} = V_{ADJ}$ )**

**Figure 15. Enable thresholds vs. temperature ( $V_{OUT} = 5$  V)**




**Figure 22. Off-state current vs. temperature**  
 ( $V_{OUT} = 5\text{ V}$ )

**Figure 23. Off-state current vs. temperature**  
 ( $V_{OUT} = V_{ADJ}$ )

**Figure 24. Short-circuit current vs. dropout voltage**  
 ( $V_{OUT} = 5\text{ V}$ )

**Figure 25. Short-circuit current vs. dropout voltage**  
 ( $V_{OUT} = V_{ADJ}$ )

**Figure 26. SVR vs. frequency**


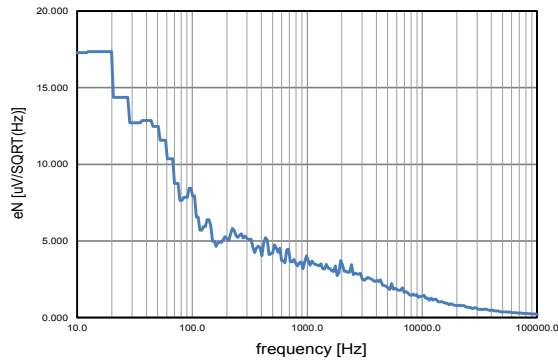
For  $V_{OUT} = 5\text{ V}$ ,  $V_{IN} = V_{EN}$  from 5.5 to 6.5V,  $I_{OUT} = 10\text{ mA}$ ,  $C_{IN} = 1\mu\text{F}$ ,  $C_{OUT} = 4.7\mu\text{F}$   
 For  $V_{OUT} = V_{ADJ}$ ,  $V_{IN} = V_{EN}$  from 2.5 to 3.5V,  $I_{OUT} = 10\text{ mA}$ , No  $C_{IN}$ ,  $C_{OUT} = 4.7\mu\text{F}$

GIPD261120151236MT

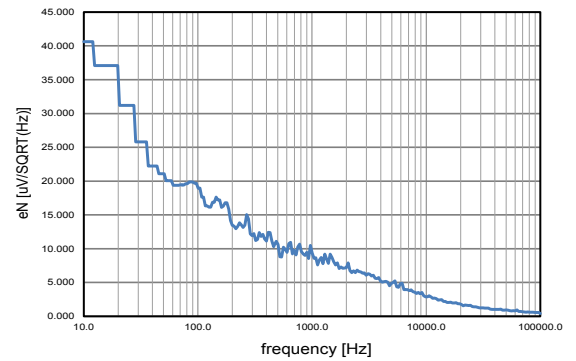
**Figure 27. Output noise spectral density**  
 ( $V_O = V_{ADJ}$ )


$V_{IN} = V_{EN} = 2.5\text{ V}$ ,  $V_{OUT} = V_{ADJ}$ ,  $I_{OUT} = 100\text{ mA}$ ,  $C_{IN} = 1\mu\text{F}$ ,  $C_{OUT} = 4.7\mu\text{F}$

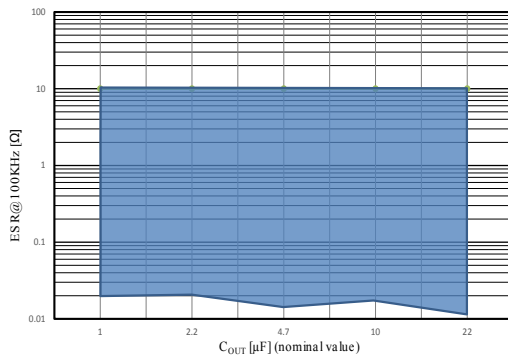
GIPD261120151237MT

**Figure 28. Output noise spectral density ( $V_O = 5\text{ V}$ )**


$V_{IN} = V_{EN} = 6\text{ V}$ ,  $V_{OUT} = 5\text{ V}$ ,  $I_{OUT} = 100\text{ mA}$ ,  $C_{IN} = 1\text{ }\mu\text{F}$ ,  $C_{OUT} = 4.7\text{ }\mu\text{F}$   
GIPD261120151238MT

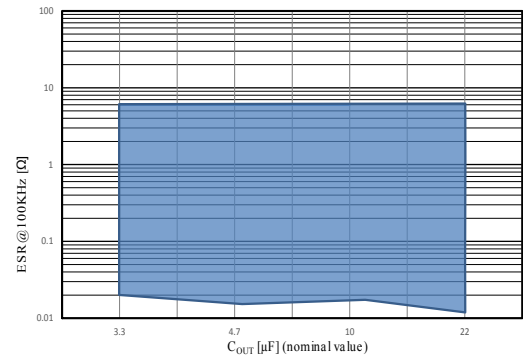
**Figure 29. Output noise spectral density ( $V_O = 12\text{ V}$ )**


$V_{IN} = V_{EN} = 6\text{ V}$ ,  $V_{OUT} = 5\text{ V}$ ,  $I_{OUT} = 100\text{ mA}$ ,  $C_{IN} = 1\text{ }\mu\text{F}$ ,  $C_{OUT} = 4.7\text{ }\mu\text{F}$   
GIPD261120151239MT

**Figure 30. Stability plan ( $V_{OUT} = 5\text{ V}$ )**


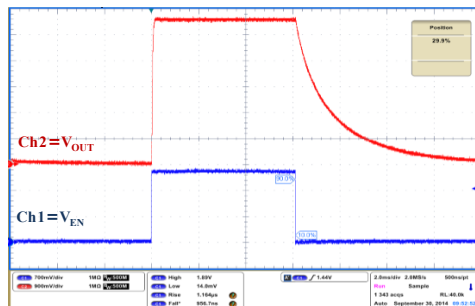
$V_{EN} = V_{IN} =$  from 6 V to 18 V,  $I_{OUT} =$  from 10 mA to 1.2 A  
(according to Max  $I_{OUT}$  vs  $V_{drop}$  characteristics),  $C_{IN} = 1\text{ }\mu\text{F}$

GIPD301120151004MT

**Figure 31. Stability plan ( $V_{OUT} = V_{ADJ}$ )**


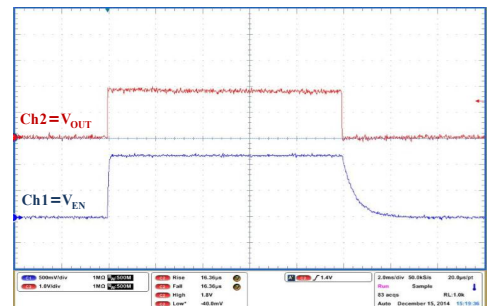
$V_{EN} = V_{IN} =$  from 2.5 V to 18 V,  $I_{OUT} =$  from 10 mA to 1.2 A  
(according to Max  $I_{OUT}$  vs  $V_{drop}$  characteristics),  $C_{IN} = 1\text{ }\mu\text{F}$

GIPD301120151005MT

**Figure 32. Startup with enable ( $V_{OUT} = 5\text{ V}$ )**


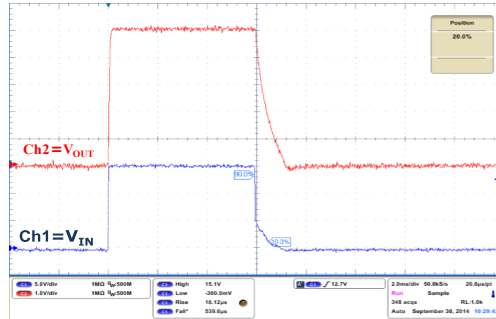
$V_{IN} = 15\text{ V}$ ,  $V_{EN}$  from 0 to 2 V,  $I_{OUT} = 10\text{ mA}$ ,  $C_{IN} = C_{OUT} = 1\text{ }\mu\text{F}$ ,  $T_{rise} = 1\text{ }\mu\text{s}$

GIPD301120151405MT

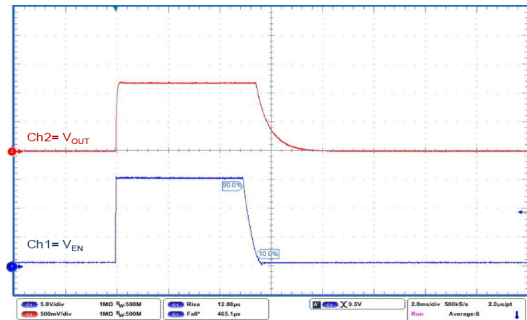
**Figure 33. Startup with enable ( $V_{OUT} = V_{ADJ}$ )**


$V_{IN} = 15\text{ V}$ ,  $V_{EN}$  from 0 to 2 V,  $I_{OUT} = 10\text{ mA}$ ,  $C_{IN} = C_{OUT} = 1\text{ }\mu\text{F}$ ,  $T_{rise} = 1\text{ }\mu\text{s}$

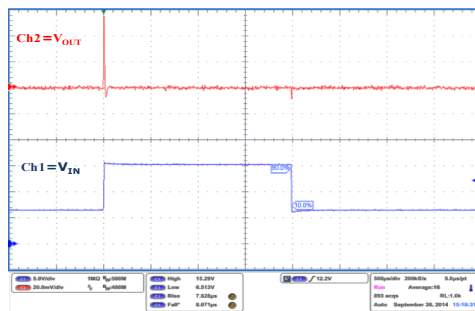
GIPD301120151406MT

**Figure 34. Turn-on time ( $V_{OUT} = 5\text{ V}$ )**

 $V_{EN} = V_{IN} =$  from 0 to 15 V,  $I_{OUT} = 10\text{ mA}$ ,  $C_{OUT} = 1\text{ }\mu\text{F}$ ,  $T_{rise} = 10\text{ }\mu\text{s}$ 

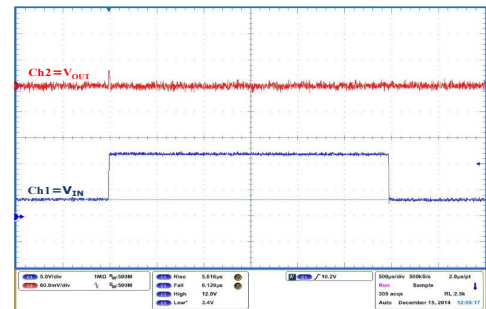
GIPD301120151407MT

**Figure 35. Turn-on time ( $V_{OUT} = V_{ADJ}$ )**

 $V_{EN} = V_{IN} =$  from 0 to 15 V,  $I_{OUT} = 10\text{ mA}$ ,  $C_{IN} = 1\text{ }\mu\text{F}$ ,  $C_{OUT} = 4.7\text{ }\mu\text{F}$ ,  $t_{rise} = 10\text{ }\mu\text{s}$ 

GIPD301120151408MT

**Figure 36. Line transient ( $V_{OUT} = 5\text{ V}$ )**

 $V_{IN} =$  from 6 to 15 V,  $I_{OUT} = 10\text{ mA}$ ,  $C_{OUT} = 4.7\text{ }\mu\text{F}$ ,  $t_r = 5\text{ }\mu\text{s}$ 

GIPD301120151409MT

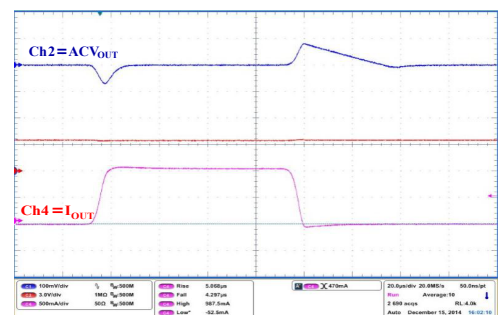
**Figure 37. Line transient ( $V_{OUT} = V_{ADJ}$ )**

 $V_{IN} =$  from 3.5 to 15 V,  $I_{OUT} = 10\text{ mA}$ , NO  $C_{IN}$ ,  $C_{OUT} = 4.7\text{ }\mu\text{F}$ ,  $t_r = 5\text{ }\mu\text{s}$ 

GIPD301120151410MT

**Figure 38. Load transient ( $V_{OUT} = 5\text{ V}$ )**

 $V_{EN}$  to  $V_{CC}$ ,  $V_{IN} = 6\text{ V}$ ,  $I_{OUT} =$  from 10 mA to 1.2 A,  $C_{IN} = 1\text{ }\mu\text{F}$ ,  $C_{OUT} = 4.7\text{ }\mu\text{F}$ ,  $T_{rise} = 5\text{ }\mu\text{s}$ 

GIPD301120151411MT

**Figure 39. Load transient ( $V_{OUT} = V_{ADJ}$ )**

 $V_{EN}$  to  $V_{CC}$ ,  $V_{IN} = 3.5\text{ V}$ ,  $I_{OUT} =$  from 10 mA to 1.2 A,  $C_{IN} = 1\text{ }\mu\text{F}$ ,  $C_{OUT} = 4.7\text{ }\mu\text{F}$ ,  $T_{rise} = 5\text{ }\mu\text{s}$ 

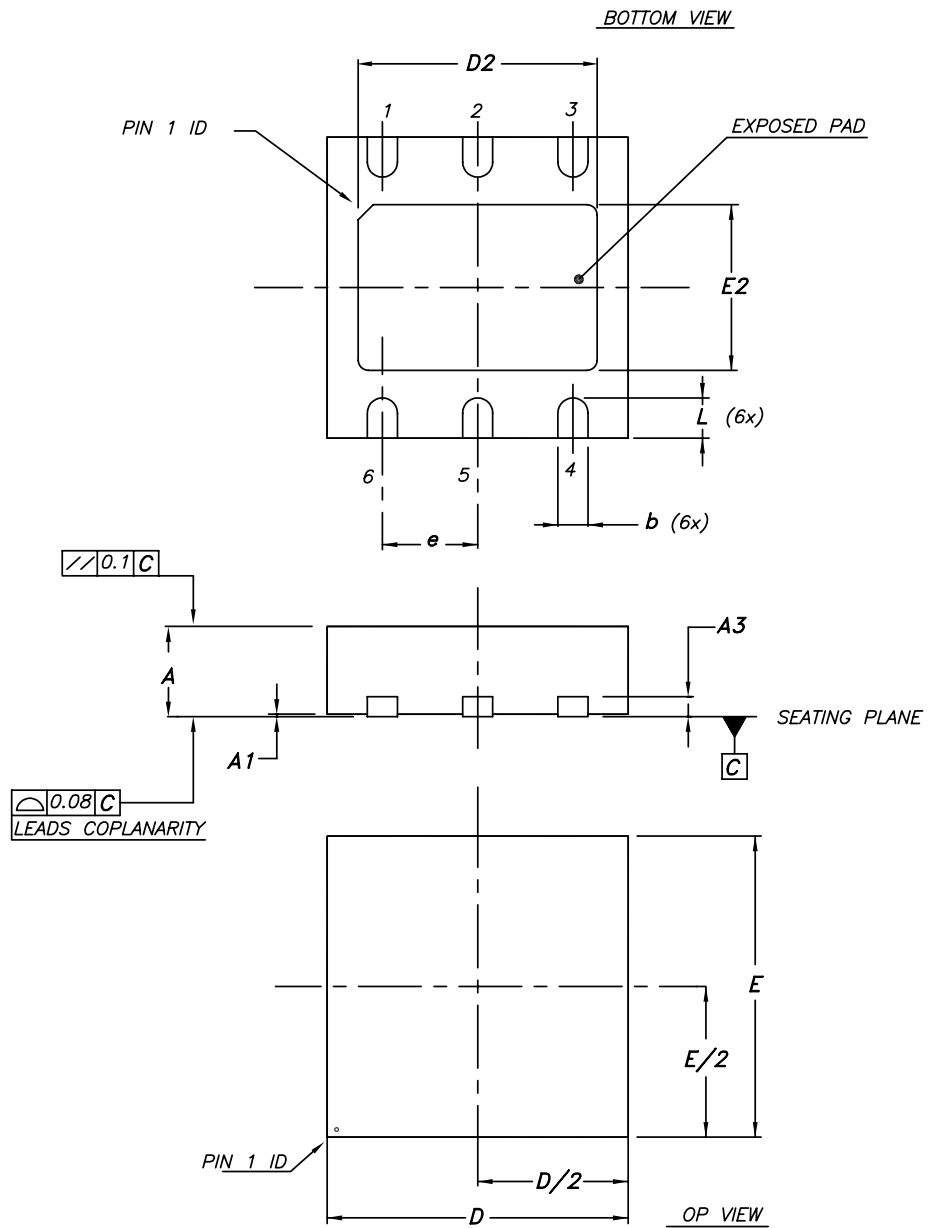
GIPD301120151412MT

## 7 Package information

In order to meet environmental requirements, ST offers these devices in different grades of **ECOPACK** packages, depending on their level of environmental compliance. ECOPACK specifications, grade definitions and product status are available at: [www.st.com](http://www.st.com). ECOPACK is an ST trademark.

### 7.1 DFN6 (3x3) package information

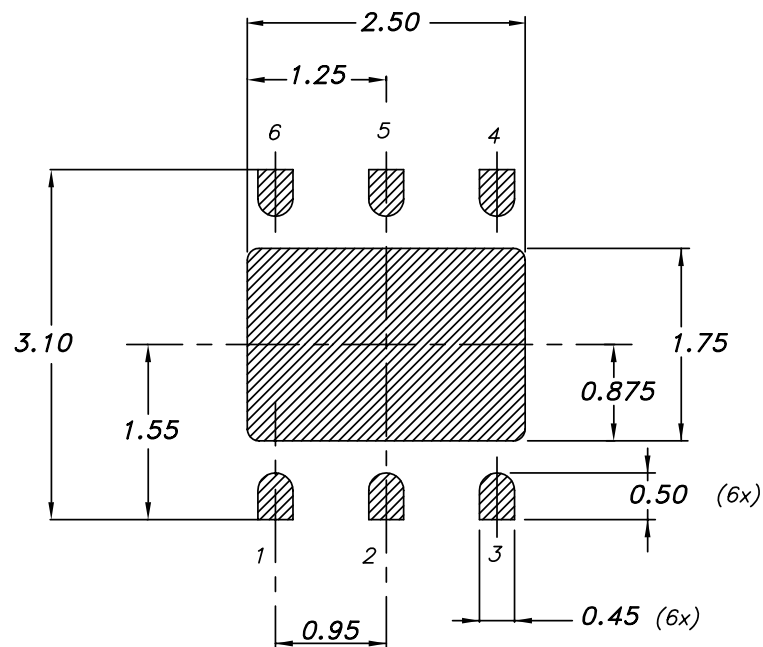
Figure 40. DFN6 (3x3) package outline



7946637\_C

**Table 5. DFN6 (3x3) mechanical data**

Dim.	mm		
	Min.	Typ.	Max.
A	0.80		1
A1	0	0.02	0.05
A3		0.20	
b	0.23		0.45
D	2.90	3	3.10
D2	2.23		2.50
E	2.90	3	3.10
E2	1.50		1.75
e		0.95	
L	0.30	0.40	0.50

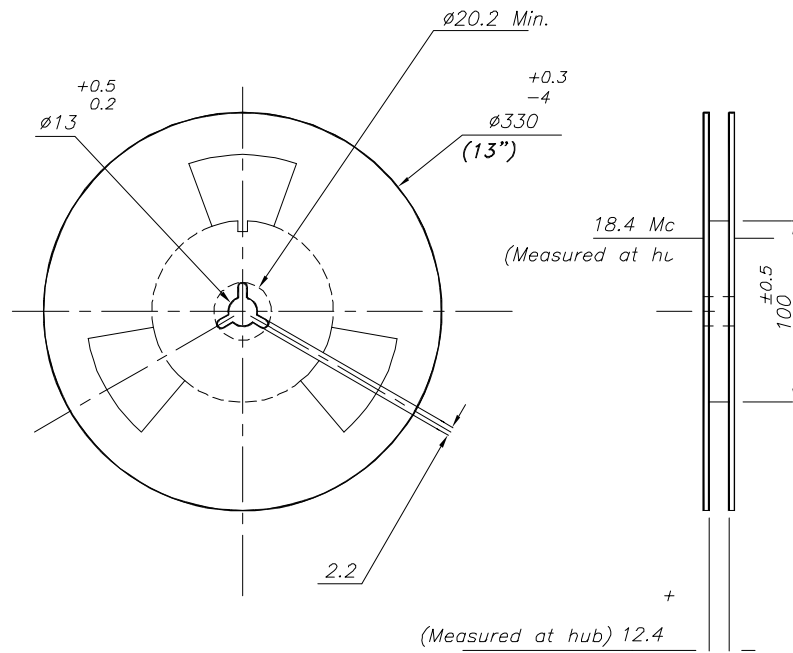
**Figure 41. DFN6 (3x3) recommended footprint**
**FOOTPRINT RECOMMENDED**


7946637\_C





Figure 43. DFN6 (3x3) reel outline



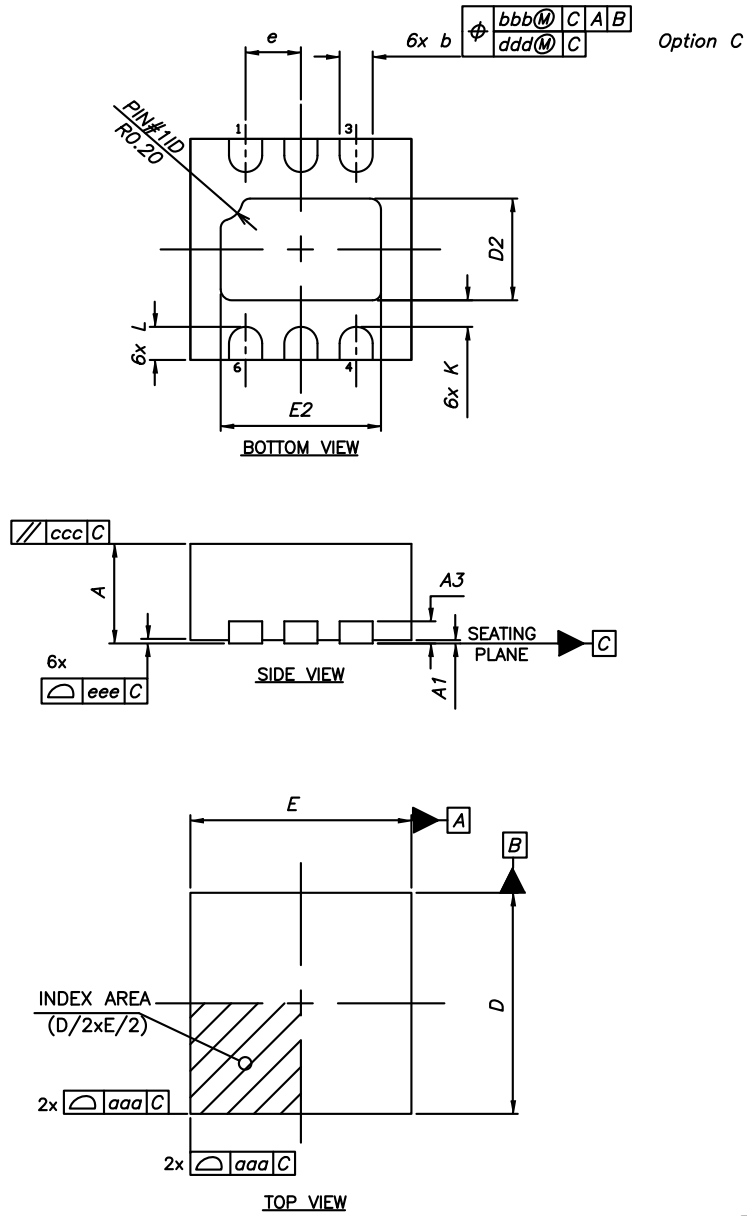
7875978\_N

Table 6. DFN6 (3x3) tape and reel mechanical data

Dim.	mm		
	Min.	Typ.	Max.
A0	3.20	3.30	3.40
B0	3.20	3.30	3.40
K0	1	1.10	1.20

### 7.3 DFN6 (2x2) package information

Figure 44. DFN6 (2x2) package outline

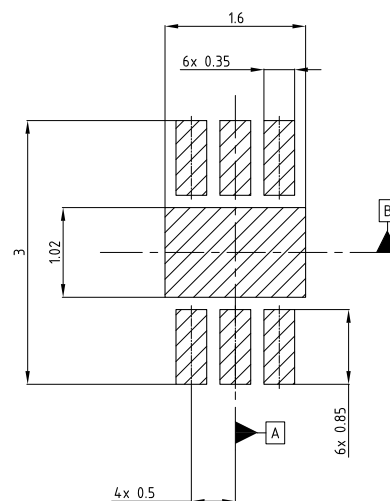


7733060

Table 7. DFN6 (2x2) mechanical data

Dim.	mm		
	Min.	Typ.	Max.
A	0.70	0.75	0.80
A1	0.00	0.02	0.05
A3	-	0.203 ref	-
b	0.25	0.30	0.35
D	-	2.00	-
E	-	2.00	-
e	-	0.50	-
D2	0.77	0.92	1.02
E2	1.30	1.45	1.55
K	0.15	-	-
L	0.20	0.30	0.40
aaa	-	0.05	-
bbb	-	0.10	-
ccc	-	0.10	-
ddd	-	0.05	-
eee	-	0.08	-

Figure 45. DFN6 (2x2) recommended footprint



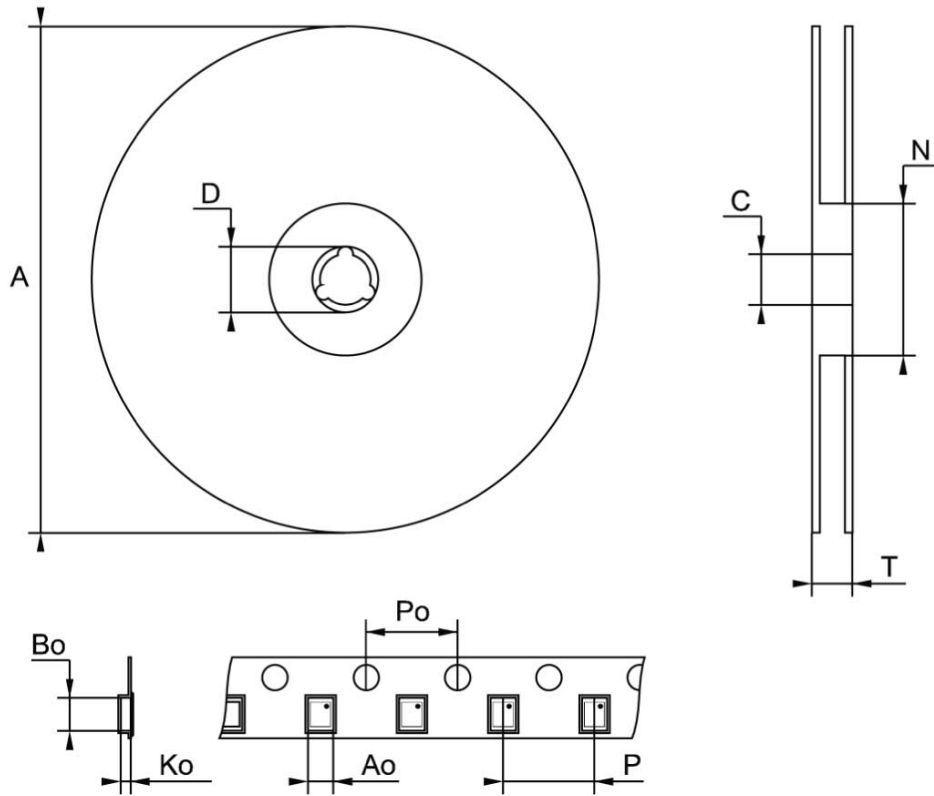
Notes:

- 1) This footprint is able to ensure insulation up to 32 Vrms (according to CEI IEC 664-1)
- 2) The device must be positioned within  $\oplus 0.02$  A B

7733060 revE

## 7.4 DFN6 (2x2) packing information

Figure 46. DFN6 (2 x 2 mm) reel outline



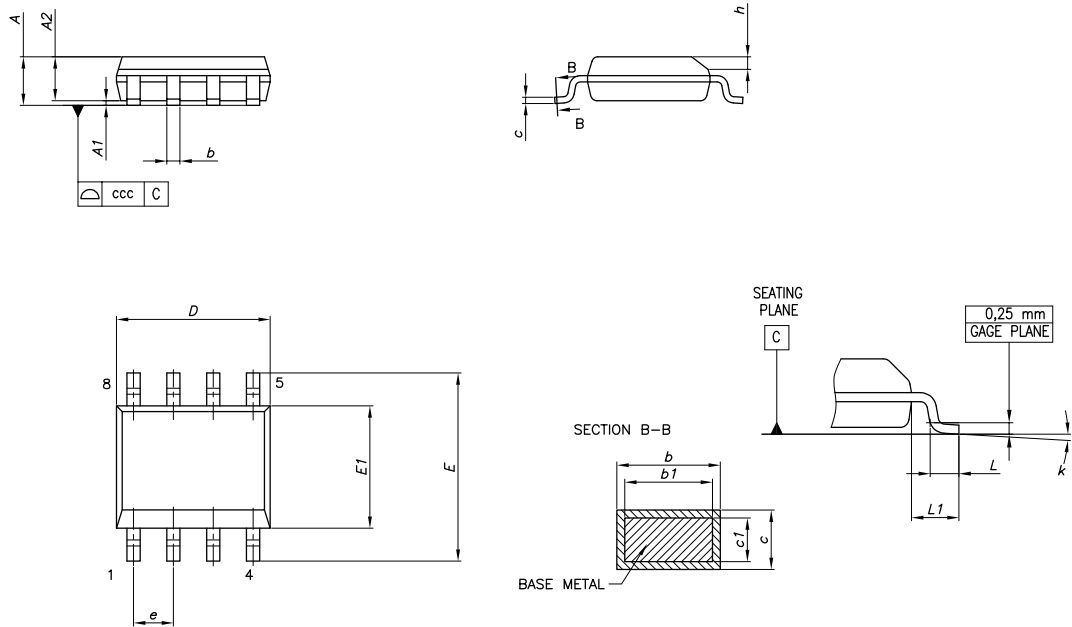
Note: Drawing not in scale

Table 8. DFN6 (2 x 2 mm) tape and reel mechanical data

Dim.	mm		
	Min.	Typ.	Max.
A			180
C	12.8		13.2
D	20.2		
N	60		
T			14.4
A0		2.4	
B0		2.4	
K0		1.3	
P0		4	
P		4	

## 7.5 SO8 package information

Figure 47. SO-8 batwing package outline

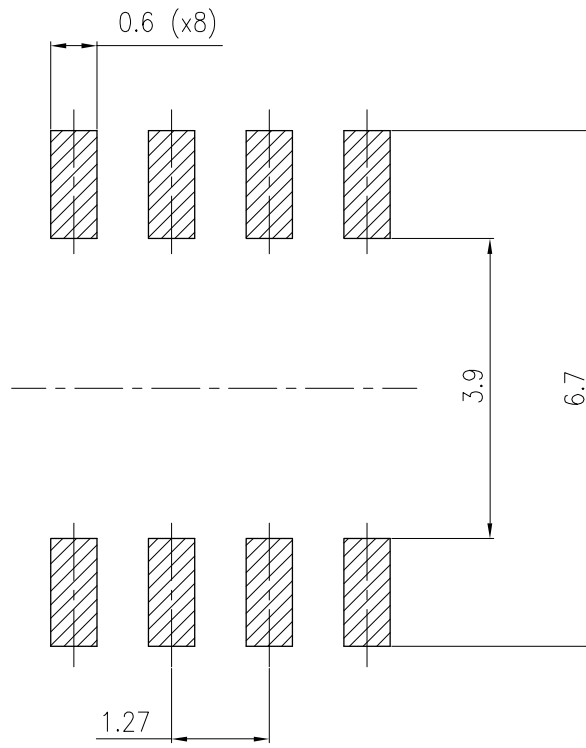


0016023\_G

Table 9. SO-8 batwing mechanical data

Dim.	mm		
	Min.	Typ.	Max.
A			1.75
A1	0.10		0.25
A2	1.25		
b	0.31		0.51
b1	0.28		0.48
c	0.10		0.25
c1	0.10		0.23
D	4.80	4.90	5.00
E	5.80	6.00	6.20
E1	3.80	3.90	4.00
e		1.27	
h	0.25		0.50
L	0.40		1.27
L1		1.04	
L2		0.25	
k	0°		8°
ccc			0.10

Figure 48. SO-8 batwing recommended footprint



0016023\_GU

## 8 Ordering information

**Table 10. Order code**

DFN6 (3x3)	DFN6 (2x2)	SO-8 batwing plastic micropackage	Output voltage (V)
LDL212PU12R <sup>(1)</sup>			1.2
LDL212PU15R			1.5
LDL212PU18R <sup>(1)</sup>			1.8
LDL212PU25R <sup>(1)</sup>			2.5
LDL212PU30R <sup>(1)</sup>			3
	LDL212PV33R	LDL212D33R	3.3
LDL212PU50R			5
LDL212PUR	LDL212PVR	LDL212DR	Adjustable

1. Available on request.

## Revision history

**Table 11. Document revision history**

Date	Revision	Changes
02-Mar-2016	1	Initial release.
19-Sep-2016	2	Updated Table 3: "Thermal data" and Section 5: "Electrical characteristics". Minor text changes.
17-Sep-2018	3	Added: GND pin name in Table 1. Pin description and new order code LDL212D33R in Table 10. Order code.
16-Apr-2019	4	In Table 10. Order code, in LDL2012D33R the note has been removed. Updated GND description in Table 1. Pin description.
21-Feb-2020	5	Added dropout voltage for SO-8 in Table 4. <a href="#">Electrical characteristics</a> .



## Contents

<b>1</b>	<b>Block diagram</b> .....	<b>2</b>
<b>2</b>	<b>Pin configuration</b> .....	<b>3</b>
<b>3</b>	<b>Typical application</b> .....	<b>4</b>
<b>4</b>	<b>Maximum ratings</b> .....	<b>5</b>
<b>5</b>	<b>Electrical characteristics</b> .....	<b>6</b>
<b>6</b>	<b>Typical performance characteristics</b> .....	<b>8</b>
<b>7</b>	<b>Package information</b> .....	<b>14</b>
7.1	DFN6 (3x3) package information .....	14
7.2	DFN6 (3x3) packing information .....	16
7.3	DFN6 (2x2) package information .....	18
7.4	DFN6 (2x2) packing information .....	20
7.5	SO8-batwing package information .....	21
7.6	SO8-batwing packing information .....	0
<b>8</b>	<b>Ordering information</b> .....	<b>23</b>
	<b>Revision history</b> .....	<b>24</b>
	<b>Contents</b> .....	<b>25</b>
	<b>List of tables</b> .....	<b>26</b>
	<b>List of figures</b> .....	<b>27</b>

## List of tables

<b>Table 1.</b>	Pin description . . . . .	3
<b>Table 2.</b>	Absolute maximum ratings . . . . .	5
<b>Table 3.</b>	Thermal data . . . . .	5
<b>Table 4.</b>	Electrical characteristics . . . . .	6
<b>Table 5.</b>	DFN6 (3x3) mechanical data . . . . .	15
<b>Table 6.</b>	DFN6 (3x3) tape and reel mechanical data . . . . .	17
<b>Table 7.</b>	DFN6 (2x2) mechanical data . . . . .	19
<b>Table 8.</b>	DFN6 (2 x 2 mm) tape and reel mechanical data . . . . .	20
<b>Table 9.</b>	SO-8 batwing mechanical data . . . . .	21
<b>Table 10.</b>	Order code . . . . .	23
<b>Table 11.</b>	Document revision history . . . . .	24

## List of figures

<b>Figure 1.</b>	Block diagram (fixed) . . . . .	2
<b>Figure 2.</b>	Block diagram (adjustable) . . . . .	2
<b>Figure 3.</b>	Pin configuration (top view) . . . . .	3
<b>Figure 4.</b>	Typical application circuit (adjustable version) . . . . .	4
<b>Figure 5.</b>	Typical application circuit (fixed version) . . . . .	4
<b>Figure 6.</b>	Output voltage vs. temperature ( $V_{IN} = 2.5\text{ V}$ , $V_{OUT} = V_{ADJ}$ , $I_{OUT} = 0\text{ mA}$ ) . . . . .	8
<b>Figure 7.</b>	Output voltage vs. temperature ( $V_{IN} = 2.5\text{ V}$ , $V_{OUT} = V_{ADJ}$ , $I_{OUT} = 1200\text{ mA}$ ) . . . . .	8
<b>Figure 8.</b>	Output voltage vs. temperature ( $V_{IN} = 6\text{ V}$ , $V_{OUT} = 5\text{ V}$ , $I_{OUT} = 10\text{ mA}$ ) . . . . .	8
<b>Figure 9.</b>	Output voltage vs. temperature ( $V_{IN} = 6\text{ V}$ , $V_{OUT} = 5\text{ V}$ , $I_{OUT} = 1200\text{ mA}$ ) . . . . .	8
<b>Figure 10.</b>	Line regulation vs. temperature ( $V_{IN} = 6\text{ to }18\text{ V}$ , $V_{OUT} = 5\text{ V}$ , $I_{OUT} = 10\text{ mA}$ ) . . . . .	9
<b>Figure 11.</b>	Line regulation vs. temperature ( $V_{IN} = 2.5\text{ to }18\text{ V}$ , $V_{OUT} = V_{ADJ}$ , $I_{OUT} = 10\text{ mA}$ ) . . . . .	9
<b>Figure 12.</b>	Load regulation vs. temperature ( $V_{IN} = 6\text{ V}$ , $V_{OUT} = 5\text{ V}$ , $I_{OUT} = 10\text{ to }1200\text{ mA}$ ) . . . . .	9
<b>Figure 13.</b>	Load regulation vs. temperature ( $V_{IN} = 2.5\text{ V}$ , $V_{OUT} = V_{ADJ}$ , $I_{OUT} = 0\text{ to }1200\text{ mA}$ ) . . . . .	9
<b>Figure 14.</b>	Enable thresholds vs. temperature ( $V_{OUT} = V_{ADJ}$ ) . . . . .	9
<b>Figure 15.</b>	Enable thresholds vs. temperature ( $V_{OUT} = 5\text{ V}$ ) . . . . .	9
<b>Figure 16.</b>	Dropout voltage vs. temperature . . . . .	10
<b>Figure 17.</b>	Quiescent current vs. temperature ( $V_{OUT} = 5\text{ V}$ , $I_{OUT} = 0\text{ mA}$ ) . . . . .	10
<b>Figure 18.</b>	Quiescent current vs. temperature ( $V_{OUT} = 5\text{ V}$ , $I_{OUT} = 600\text{ mA}$ , $1.2\text{ A}$ ) . . . . .	10
<b>Figure 19.</b>	Quiescent current vs. temperature ( $V_{OUT} = V_{ADJ}$ , $I_{OUT} = 0\text{ mA}$ ) . . . . .	10
<b>Figure 20.</b>	Quiescent current vs. temperature ( $V_{OUT} = V_{ADJ}$ , $I_{OUT} = 600\text{ mA}$ ) . . . . .	10
<b>Figure 21.</b>	Quiescent current vs. temperature ( $V_{OUT} = V_{ADJ}$ , $I_{OUT} = 1.2\text{ A}$ ) . . . . .	10
<b>Figure 22.</b>	Off-state current vs. temperature ( $V_{OUT} = 5\text{ V}$ ) . . . . .	11
<b>Figure 23.</b>	Off-state current vs. temperature ( $V_{OUT} = V_{ADJ}$ ) . . . . .	11
<b>Figure 24.</b>	Short-circuit current vs. dropout voltage ( $V_{OUT} = 5\text{ V}$ ) . . . . .	11
<b>Figure 25.</b>	Short-circuit current vs. dropout voltage ( $V_{OUT} = V_{ADJ}$ ) . . . . .	11
<b>Figure 26.</b>	SVR vs. frequency . . . . .	11
<b>Figure 27.</b>	Output noise spectral density ( $V_O = V_{ADJ}$ ) . . . . .	11
<b>Figure 28.</b>	Output noise spectral density ( $V_O = 5\text{ V}$ ) . . . . .	12
<b>Figure 29.</b>	Output noise spectral density ( $V_O = 12\text{ V}$ ) . . . . .	12
<b>Figure 30.</b>	Stability plan ( $V_{OUT} = 5\text{ V}$ ) . . . . .	12
<b>Figure 31.</b>	Stability plan ( $V_{OUT} = V_{ADJ}$ ) . . . . .	12
<b>Figure 32.</b>	Startup with enable ( $V_{OUT} = 5\text{ V}$ ) . . . . .	12
<b>Figure 33.</b>	Startup with enable ( $V_{OUT} = V_{ADJ}$ ) . . . . .	12
<b>Figure 34.</b>	Turn-on time ( $V_{OUT} = 5\text{ V}$ ) . . . . .	13
<b>Figure 35.</b>	Turn-on time ( $V_{OUT} = V_{ADJ}$ ) . . . . .	13
<b>Figure 36.</b>	Line transient ( $V_{OUT} = 5\text{ V}$ ) . . . . .	13
<b>Figure 37.</b>	Line transient ( $V_{OUT} = V_{ADJ}$ ) . . . . .	13
<b>Figure 38.</b>	Load transient ( $V_{OUT} = 5\text{ V}$ ) . . . . .	13
<b>Figure 39.</b>	Load transient ( $V_{OUT} = V_{ADJ}$ ) . . . . .	13
<b>Figure 40.</b>	DFN6 (3x3) package outline . . . . .	14
<b>Figure 41.</b>	DFN6 (3x3) recommended footprint . . . . .	15
<b>Figure 42.</b>	DFN6 (3x3) tape outline . . . . .	16
<b>Figure 43.</b>	DFN6 (3x3) reel outline . . . . .	17
<b>Figure 44.</b>	DFN6 (2x2) package outline . . . . .	18
<b>Figure 45.</b>	DFN6 (2x2) recommended footprint . . . . .	19
<b>Figure 46.</b>	DFN6 (2 x 2 mm) reel outline . . . . .	20
<b>Figure 47.</b>	SO-8 batwing package outline . . . . .	21
<b>Figure 48.</b>	SO-8 batwing recommended footprint . . . . .	22

**IMPORTANT NOTICE – PLEASE READ CAREFULLY**

STMicroelectronics NV and its subsidiaries (“ST”) reserve the right to make changes, corrections, enhancements, modifications, and improvements to ST products and/or to this document at any time without notice. Purchasers should obtain the latest relevant information on ST products before placing orders. ST products are sold pursuant to ST’s terms and conditions of sale in place at the time of order acknowledgement.

Purchasers are solely responsible for the choice, selection, and use of ST products and ST assumes no liability for application assistance or the design of Purchasers’ products.

No license, express or implied, to any intellectual property right is granted by ST herein.

Resale of ST products with provisions different from the information set forth herein shall void any warranty granted by ST for such product.

ST and the ST logo are trademarks of ST. For additional information about ST trademarks, please refer to [www.st.com/trademarks](http://www.st.com/trademarks). All other product or service names are the property of their respective owners.

Information in this document supersedes and replaces information previously supplied in any prior versions of this document.

© 2020 STMicroelectronics – All rights reserved