



SPECIFICATIONS

Model	Stroke mm	Max Absorption Energy J(kgf·m)	Max Equivalent Mass kg (kgf)
FK-3035L-S	35	196(20)	1,560(1,560)

Max Drag N (kgf)	Max. Absorption Energy per min. J/min(kgf·m/min)	Extension Force N(kgf)	Mass g
1,176 (120)	14,700(1,500)	47.1(4.8) or lower	628

COMMON SPECIFICATIONS

Range of Impact Rate	m/s	0.3~1
Maximum Cycle Rate	cycle/min	30
Operating Temperature	C°	-5~70

CHARACTERISTICS

- With a fixed, specially-designed orifice structure, an optimal impact absorption can be achieved even under variable operating conditions.
- The main unit can also be used as a stopper. (No external stopper required, except for FK-3625A)
- Three different types are available to accommodate various speeds. For low-speed: L, for medium-speed: M, for highspeed: H.
- Urethane cap specification is also available.
- Two or more of each product can be used in parallel.
- This product can also be custom-designed for optimal impact absorption.

PRECAUTIONS FOR USE

- Do not use this product without carefully reading the attached owner's manual.
- Do not turn the oil inlet screw located at the bottom of the main unit.
- Ensure that sufficient mounting strength is secured for this product. (As a guideline, it should be 2 to 3 times the maximum drag listed in the catalogue.)
- Do not use this product in a vacuum or a location where it may come in contact with oil.
- Ensure that an eccentric load is not applied to the soft absorber. (Allowable eccentric angle: $\pm 2.5^\circ$)
- We recommend that you use it with an external stopper(OP-020**).
- Urethane caps are consumable goods that need to be replaced with new ones if necessary.

OPTIONAL PARTS

Eccentric angle adaptor OP-010TB

- When attaching the eccentric angle adaptor, screw it into the main unit until the cap for eccentric angle and the piston rod form a tight connection. While maintaining this position, fasten the main unit's nut until secured.
 - * If the eccentric angle adaptor is secured without establishing a tight fit, a sufficient stroke cannot be obtained. Furthermore, if the eccentric angle adaptor is further screwed in, after it has formed a tight connection, and then secured in place, the cap for eccentric angle cannot be pushed all the way to the stroke end.
- The inclined adapter is not available for models with soft absorber cap (-C) and urethane cap (-R)

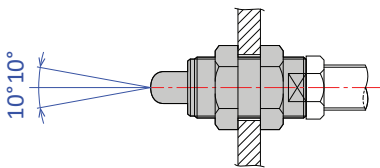
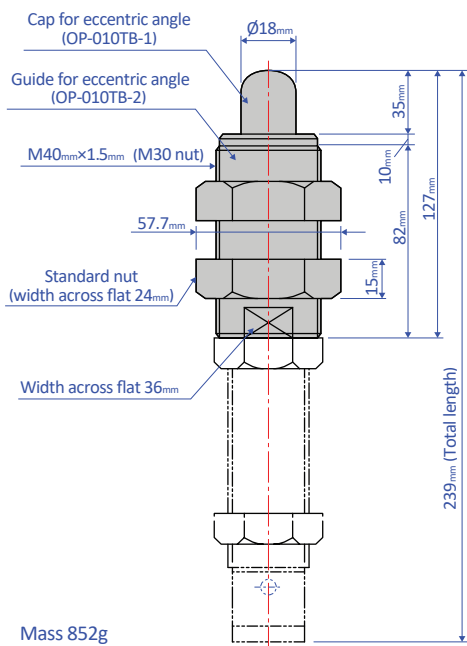

Stopper nut OP-020TB

- Adjust so that it stops 1 mm before the stroke end, and fasten with the main unit's nut until secured.

OP-020TB-S (without cap)

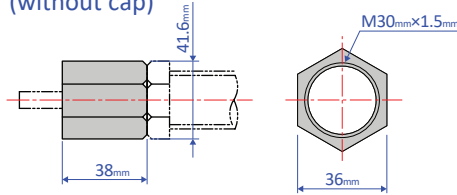

Mass 139g

OP-020TB-C (with cap)

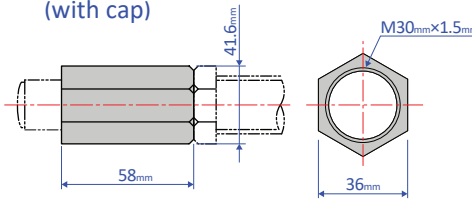

Mass 197g

Note: When attaching, make sure that the side without a bearing chamfer is the impact surface.

Standard nuts are sold separately as well - M30 Nut

Liquid-proof cap FK-3035L-C-060

- The main unit is supplied in assembly
- Ideal for use in environments where oil splatter poses a problem.
- Ensure that the cap is facing upward. If the cap is facing sideways or downward, it cannot provide an effective means for liquid proofing.

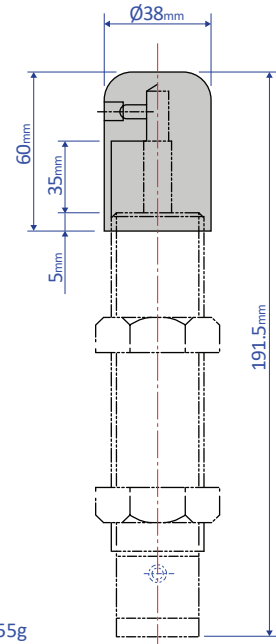

Mass 255g

Note: Liquid-proof caps are not sold separately

Flange OP-040TB

- This is a mounting fixture for soft absorbers

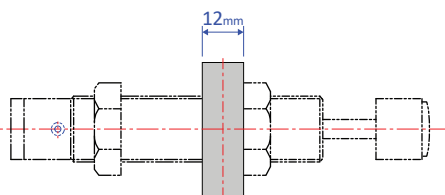
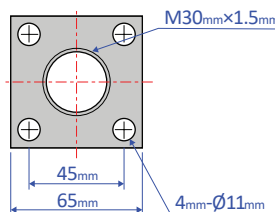

Mass 344g

Urethane cap OP-090M30A

