



Positronic®
an Amphenol company

Front Runner

Circular Connectors



FEATURING HIGH PERFORMANCE,
LIGHTWEIGHT,
COMPOSITE CONSTRUCTION

Catalog C-015 Rev. E2

www.connectpositronic.com

Connector Excellence®

Positronic Provides Complete Capability

Mission Statement

"To utilize product flexibility and application assistance to present quality interconnect solutions which represent value to customers worldwide."

Experience

- Founded in **1966**
- **Involvement** in the development of international connector specifications through EIA®, IEC and ISO as well as PICMG®.
- Introduction of new and **unique connector products** to the electronics industry.
- Patent holder for many **unique connector features and manufacturing techniques**.
- **Vertically integrated** manufacturing – raw materials to finished connectors.

Technology

- **Expertise** with solid machined contacts provides a variety of high reliability connectors including high current density power connectors.
- Quality Assurance lab is **capable of testing** to IEC, EIA, UL, CUL, military and customer-specified requirements.
- **In-house design and development** of connectors based on market need or individual customer requirements.
- **Internal manufacturing capabilities** include automatic precision contact machining, injection molding, stamping, plating operations and connector assembly.
- **Manufacturing locations** in southwest Missouri, U.S.A. (headquarters); Puerto Rico, France, China, Singapore, and India. Total square footage: 407,441.

Support

- **Quality Systems:** Select locations qualified to ISO 9001, ISO 14001, AS9100, MIL-STD-790 and customer "dock to stock" programs. Applicable products qualified to MIL-DTL-24308, SAE AS39029, DSCC 85039, MIL-DTL-28748, Space D32, GSFC S-311-P-4 and GSFC S-311-P-10.
- Compliance to a variety of international and customer specific **environmental requirements**.
- Large **in-house inventory** of finished connectors. Customer specific **stocking programs**.
- Factory direct **technical sales support** in major cities worldwide.
- **One-on-one customer support** from worldwide factory locations.
- World class **web site**.
- **Value-added solutions** and willingness to **develop custom products** with reasonable price and delivery.



Regional Headquarters

Springfield, MO



Auch, France



Singapore



Products described within this catalog may be protected by one or more of the following US patents:

#4,900,261* #5,255,580 #5,329,697
#6,260,268 #6,835,079 #7,115,002

*Patented in Canada, 1992 Other Patents Pending

Positronic Industries' **FEDERAL SUPPLY CODE** (Cage Code)
FOR MANUFACTURERS is **28198**

Unless otherwise specified, **dimensional tolerances are:**

- 1) ± 0.001 inches [0.03 mm] for male contact mating diameters.
- 2) ± 0.003 inches [0.08 mm] for contact termination diameters.
- 3) ± 0.005 inches [0.13 mm] for all other diameters.
- 4) ± 0.015 inches [0.38 mm] for all other dimensions.

POSITRONIC® IS AN ITAR REGISTERED COMPANY

Information in this catalog is proprietary to Positronic and its subsidiaries. Positronic believes the data contained herein to be reliable. Since the technical information is given free of charge, the user employs such information at his own discretion and risk. Positronic Industries assumes no responsibility for results obtained or damages incurred from use of such information in whole or in part.

The following trademarks are registered to Positronic Industries, Inc. in the United States and many other countries: Positronic Industries, Inc.®, Positronic®, Connector Excellence®, P+ logo®, PosiBand®, PosiShop®, Positronic Global Connector Solutions®, Global Connector Solutions®. The color blue as it appears on various connectors is a trademark of Positronic Industries, Inc., Registered in U.S. Patent and Trademark Office.

HIGH PERFORMANCE, LIGHTWEIGHT, COMPOSITE CONSTRUCTION



- **SIZES 11 AND 19** connector diameters.
- **16 CONTACT ARRANGEMENTS** from 3 to 29 contacts.
- **EASY CONTACT SERVICING:** Rear insertion/front release of removable contacts.
- **TWO LEVEL SEQUENTIAL MATING OF CONTACTS.**
- **NON-CORRODIBLE/LIGHTWEIGHT COMPOSITE MATERIALS.**
- **ENVIRONMENTAL VERSION** features dust and water ingress protection to IEC IP67 (1 meter immersion for 30 minutes) in mated condition.
- **EMI/RFI SHIELDED VERSION**, electroless nickel plated plastic.
- **THERMOCOUPLE CONTACTS.**



Positronic
connectpositronic.com

TABLE OF CONTENTS

Front
Runner

GENERAL INFORMATION

General Product Information	1
Typical Connector Assemblies	2
Contact Arrangements	3

TECHNICAL INFORMATION

Technical Information	4
“Large Surface Area” Contact Mating System	5
Temperature Rise Curves	5

DIMENSIONS

Housing Dimensions	6-7
Straight and 90° Printed Board Mount Connectors	8-9
Straight Printed Board Contact Hole Patterns	10
90° Printed Board Contact Hole Patterns	11

ORDERING INFORMATION

Ordering Information	12
Special Options	13

ACCESSORIES

Non-Environmental Version Accessories	14-15
Accessories and Panel Cutouts	15
Environmental Version Data	16
EMI/RFI Shielded Version Data	17

CONTACTS

Removable Contacts	18-19
Thermocouple Contacts	20
Crimp Shielded Contacts	21-22

APPLICATION TOOLS

Introduction	23
Contact Application Tools Cross Reference List	24

GENERAL INFO

TECH INFO

DIMENSIONS

ORDERING INFO

ACCESSORIES

CONTACTS

APPL TOOLING



The **Front Runner Series** offers a multiplicity of connector features which makes it a first choice to meet the high performance and high reliability requirements of Medical, Transportation, Industrial Control, and Avionics applications. **Front Runner** features include:



1. Composite components: Lightweight and non-corrodible. Contacts machined from solid copper alloy.
2. Sixteen (16) contact arrangements from 3 to 29 contacts.
3. Hot pluggable capabilities to 25 amperes.
4. Two level sequential mating of contacts.
5. A mix of power and signal contacts in Sizes 12, 16, 20, and 22. Crimp removable contacts and printed board straight and right angle terminations.
6. Mounting options include flange and jam nut or printed circuit board mount.
7. Environmental version provides dust and water ingress protection to I.E.C. IP67 (1 meter immersion for 30 minutes in mated condition).
8. EMI/RFI shielded version, electroless nickel plated plastic.
9. Easy contact servicing - rear insertion/front release contact retention system.
10. Threaded coupling nut system.

Contact Technical Sales for additional information.



Positronic
connectpositronic.com

TYPICAL CONNECTOR ASSEMBLIES

Front
Runner

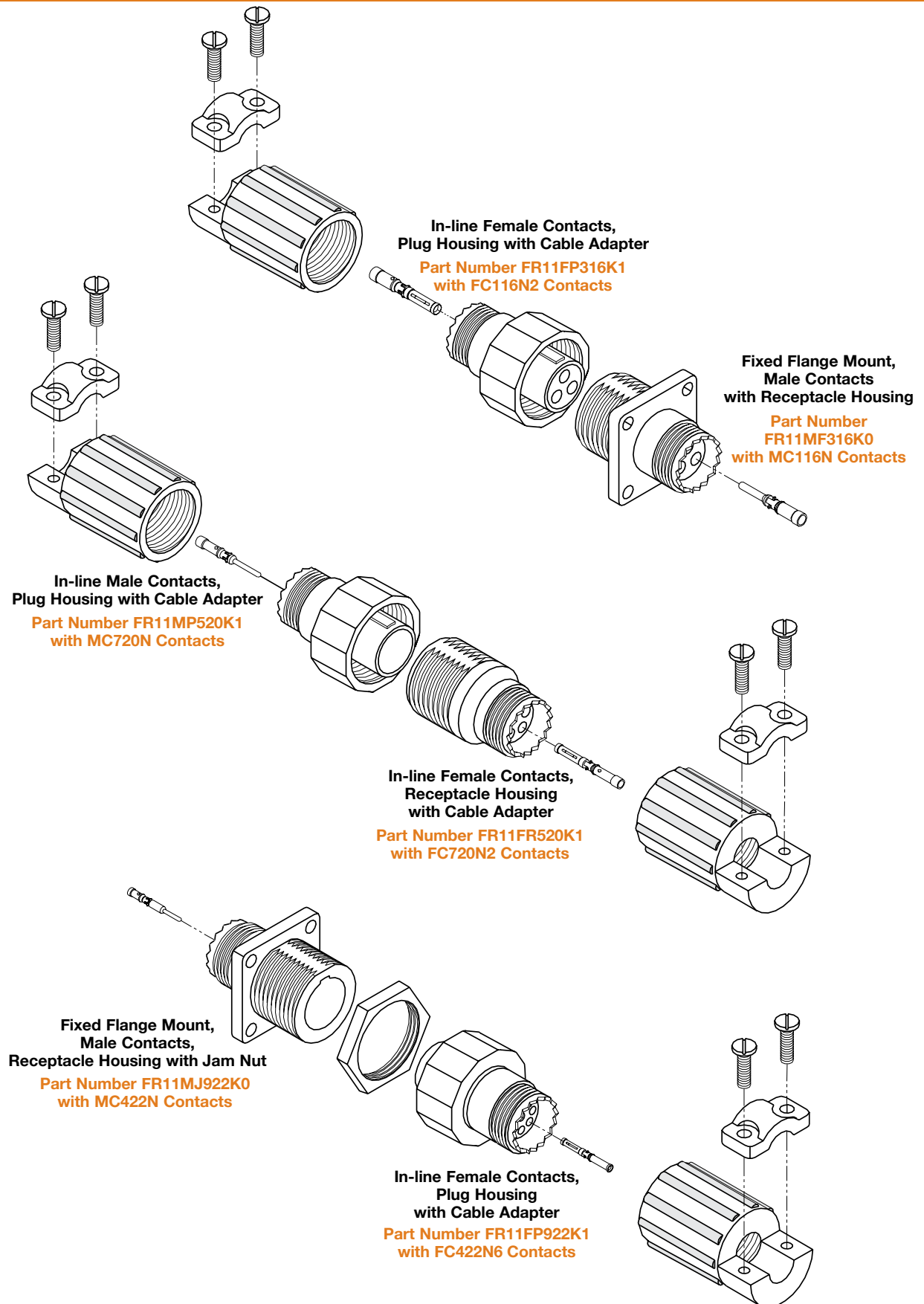



CONTACT ARRANGEMENTS FOR SIZE 11 HOUSING

VOLTAGE RATINGS PER EN60950 * INSULATION RESISTANCE OF 5 G OHMS

CONTACT ARRANGEMENTS ARE SHOWN APPROXIMATELY ACTUAL SIZE
MATING FACE OF MALE OR REAR VIEW OF FEMALE CONNECTOR SHOWN



316

Three (3) Size 16 Contacts
0.063 inch [1.6 mm] minimum creepage
for operation at 300V RMS



520

Five (5) Size 20 Contacts
0.039 inch [1.0 mm] minimum creepage
for operation at 200V RMS



822

Eight (8) Size 22 Contacts
0.028 inch [0.7 mm] minimum creepage
for operation at 100V RMS



420

Four (4) Size 20 Contacts
0.059 inch [1.5 mm] minimum creepage
for operation at 250V RMS



722

Seven (7) Size 22 Contacts
0.063 inch [1.6 mm] minimum creepage
for operation at 300V RMS



922

Nine (9) Size 22 Contacts
0.028 inch [0.7 mm] minimum creepage
for operation at 100V RMS

CONTACT ARRANGEMENTS FOR SIZE 19 HOUSING

VOLTAGE RATINGS PER EN60950 * INSULATION RESISTANCE OF 5 G OHMS

CONTACT ARRANGEMENTS ARE SHOWN APPROXIMATELY ACTUAL SIZE
MATING FACE OF MALE OR REAR VIEW OF FEMALE CONNECTOR SHOWN

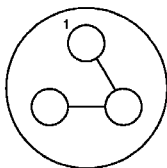

312

Three (3) Size 12 Contacts
0.197 inch [5.0 mm]
minimum creepage for
operation at 600V RMS

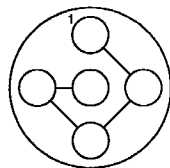

512

Five (5) Size 12 Contacts
0.091 inch [2.3 mm]
minimum creepage for
operation at 400V RMS

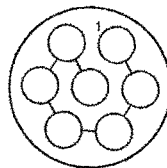

712

Seven (7) Size 12 Contacts
0.071 inch [1.8 mm]
minimum creepage for
operation at 300V RMS

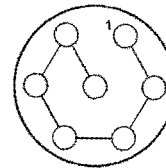

716

Seven (7) Size 16 Contacts
0.189 inch [4.8 mm]
minimum creepage for
operation at 600V RMS

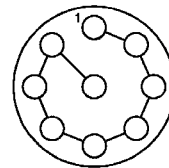

916

Nine (9) Size 16 Contacts
0.118 inch [3.0 mm]
minimum creepage for
operation at 400V RMS

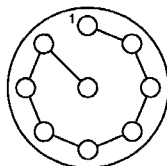

920

Nine (9) Size 20 Contacts
0.154 inch [3.9 mm]
Minimum Creepage for
Operation at 600V RMS

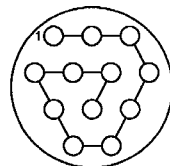

1220

Twelve (12) Size 20 Contacts
0.102 inch [2.6 mm]
minimum creepage for
operation at 400V RMS

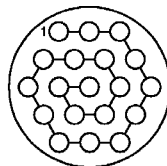

1920

Nineteen (19) Size 20 Contacts
0.059 inch [1.5 mm]
minimum creepage for
operation at 250V RMS

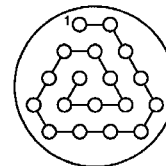

1822

Eighteen (18) Size 22 Contacts
0.086 inch [2.2 mm]
minimum creepage for
operation at 400V RMS

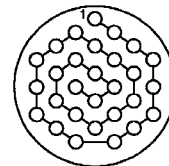

2922

Twenty-nine (29)
Size 22 Contacts
0.051 inch [1.3 mm]
minimum creepage for
operation at 250V RMS

• NOTE: Contact Technical Sales for availability of other contact arrangements.



TECHNICAL CHARACTERISTICS

MATERIALS AND FINISHES:

Insulator Inserts: Glass-filled DAP, Type SDG-F, black color, UL 94V-0.

Non-Environmental Connectors:

Housings: Glass-filled polyester, black color, UL 94V-0.

Coupling Nut: Glass-filled polyester, black color, UL 94V-0.

Cable Adapters: Glass-filled polyester, black color, UL 94V-0.

Environmental Connectors:

Interfacial O-Rings: T.P.E.

Cable Adapters: Glass-filled polyester with T.P.E. boot.

Dust Cover: Glass-filled polyester, black color, or low density polyethylene, black color, UL 94V-0.

EMI/RFI Shielded Connectors:

Housings: Thermoplastic, electroless nickel over copper plated.

Cable Adapters: Thermoplastic, electroless nickel over copper plated.

Contacts: Copper alloy with gold flash over nickel or 0.000030 inch [0.76 microns] gold plate over nickel plate.

Jam Nuts: Aluminum, black anodized.

MECHANICAL CHARACTERISTICS:

Polarization: Plug and receptacle housings are molded with integral polarization system.

Removable Contacts: Rear insertion/Front release removal. Female contact features "Closed Entry Design" for highest reliability.

Contact Retention in Insulator:

Size 22: 6 lbs. [27 N] per IEC 60512-8, Test 15a.
Size 20: 10 lbs. [44 N] per IEC 60512-8, Test 15a.
Size 16: 20 lbs. [89 N] per IEC 60512-8, Test 15a.
Size 12: 20 lbs. [89 N] per IEC 60512-8, Test 15a.

Sequential Contact

Mating Systems: One and two level systems. Contact Technical Sales for ordering information.

Coupling System:

Size 11 Housing: M19 coupling nut.
Size 19 Housing: M32 coupling nut.

Printed Board

Contact Terminations: Straight and 90° solder terminations.

Mechanical Operations: 500 operations.

ELECTRICAL CHARACTERISTICS:

Nominal Contact Current Rating:

Size 12: 25 amperes.
Size 16: 13 amperes.
Size 20: 7.5 amperes.
Size 22: 5 amperes.

Initial Contact Resistance, Maximum:

Size 12: 0.001 ohms per IEC 60512-2, Test 2b.
Size 16: 0.0016 ohms per IEC 60512-2, Test 2b.
Size 20: 0.007 ohms per IEC 60512-2, Test 2b.
Size 22: 0.012 ohms per IEC 60512-2, Test 2b.

Size 16 Micro-Coaxial Contacts:

See page 22 for technical information.

Insulation Resistance:

5 G ohms per IEC 60512-2, Test 3a, Method A.

Creepage and Clearance Distance:

See values given with the specific contact arrangements on page 3.

Working Voltage:

See values given with the specific contact arrangements on page 3.

Hot Pluggable

(50 couplings per UL 1977, paragraph 15):

Size 12 Contacts: 250 VAC at 25 amperes.
Size 16 Contacts: 120 VAC at 4.5 amperes.

CLIMATIC CHARACTERISTICS:

Working Temperature: -55°C to +125°C.

Dust and Water Ingress:

Per IEC IP67 (1 meter immersion for 30 minutes) in mated condition.

EMI/RFI SHIELDING CHARACTERISTICS:

Surface Conductivity: < 0.5 ohm per square.

Attenuation: 70-80 dB at most frequencies.

THERMOCOUPLE CONTACTS:

Size 20 and 22 crimp contacts are available. See page 20 for details.

PCB mount contacts are available please contact Technical Sales for details.



FRONT RUNNER HIGH PERFORMANCE CONTACTS "LARGE SURFACE AREA CONTACT MATING SYSTEM" HIGH RELIABILITY "CLOSED ENTRY" DESIGN PRECISION MACHINED SOLID COPPER ALLOY

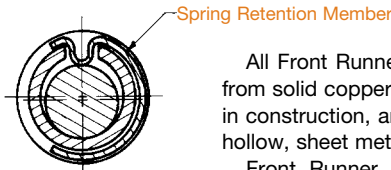
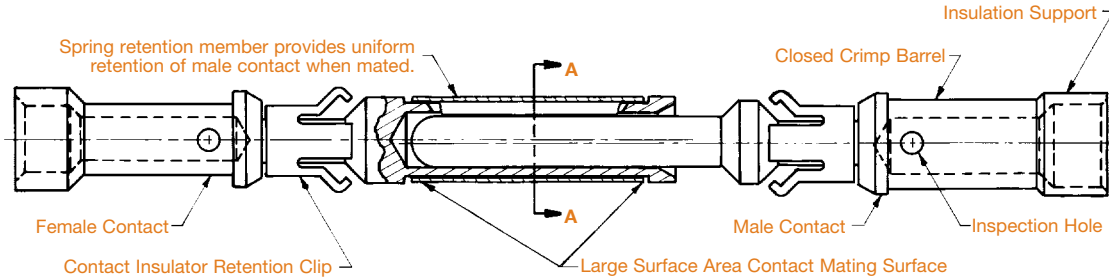

**SECTION A-A
ENLARGED**

All contacts of Positronic's Front Runner Series utilize the "Large Surface Area (L.S.A.) Contact Mating System." The "L.S.A. Contact Mating System" insures the lowest level of contact resistance during mechanical endurance tests of 1000 coupling cycles or more. Contact insertion/withdrawal forces remain substantially the same during the life of the connector.

Front Runner Series use only "Closed Entry" design female contacts. The "Closed Entry" design prevents probe damage to the female contacts, and will not allow the female contact to accept misaligned or bent male contacts.

All Front Runner Series contacts are precision machined from solid copper alloy barstock. They are durable, smooth in construction, and have greater amperage capacities than hollow, sheet metal-style contacts.

Front Runner Series contacts, having a large contact surface area, produce less heat at the contact surface, thereby permitting the connector to operate at high amperage levels continuously and still maintain lower connector temperatures.

CONNECTOR TEMPERATURE RISE CURVES

Tested per IEC Publication 60512-5-2, Test 5a

Size 16 Contact / Size 20 Contacts / Size 11 Housing

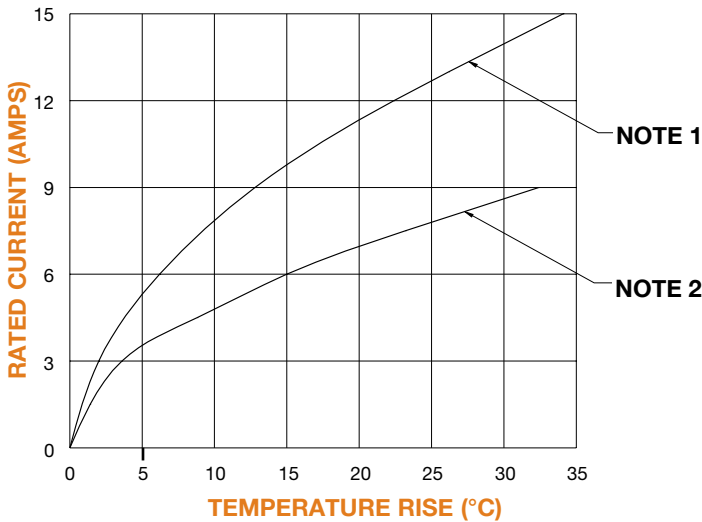

NOTE 1:

Curve developed using FR11MP316K0 and FR11FF316K0 connectors, MC116N and FC116N2 crimp contacts and 16 AWG [1.5 mm²] size wire. All contacts under load.

NOTE 2:

Curve developed using FR11MP520K0 and FR11FF520K0 connectors, MC720N and FC720N2 crimp contacts and 20 AWG [0.5 mm²] size wire. All contacts under load.

Size 12 Contact / Size 16 Contacts / Size 19 Housing

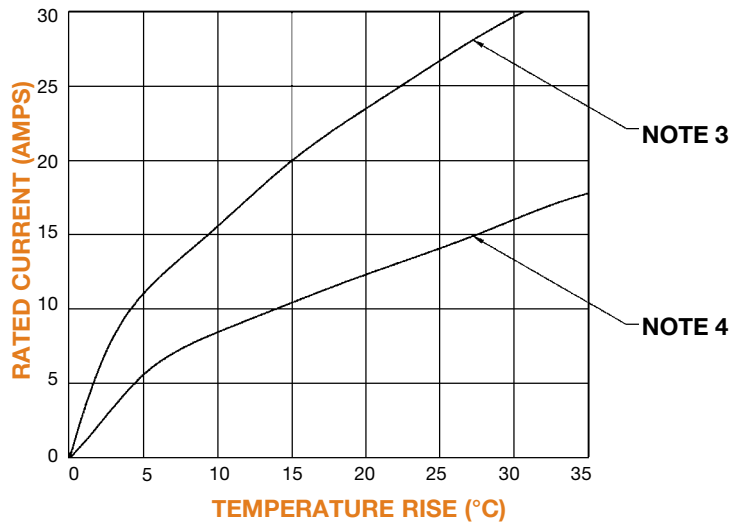

NOTE 3:

Curve developed using FR19MF312K0 and FR19FP312K0 connectors, MC612N and FC612N2 crimp contacts and 12 AWG [4.0 mm²] size wire. All contacts under load.

NOTE 4:

Curve developed using FR19MF716K0 and FR19FP716K0 connectors, MC116N and FC116N2 crimp contacts and 16 AWG [1.5 mm²] size wire. All contacts under load.

**DIMENSIONS ARE IN INCHES [MILLIMETERS].
ALL DIMENSIONS ARE SUBJECT TO CHANGE.**



FIXED FLANGE-MOUNT HOUSING RECEPTACLE HOUSING, MALE OR FEMALE CONTACTS

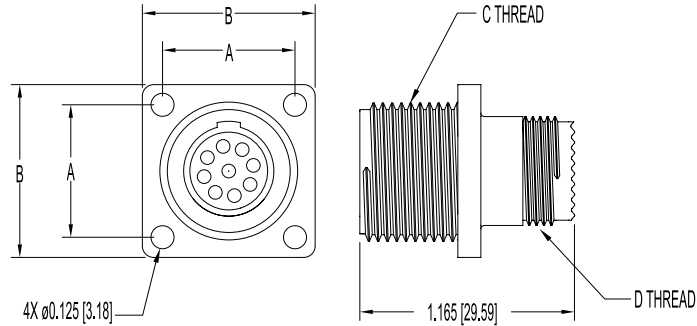

DIMENSION	SIZE 11 HOUSING	SIZE 19 HOUSING
A	0.719 [18.26]	1.062 [26.97]
B	0.938 [23.83]	1.438 [36.53]
C Thread	M19	M32
D Thread	M15	M28

MATERIALS:

Insert: Glass-filled DAP.

Housing: Glass-filled polyester.

FREE IN-LINE HOUSINGS

PLUG HOUSING, MALE OR FEMALE CONTACTS

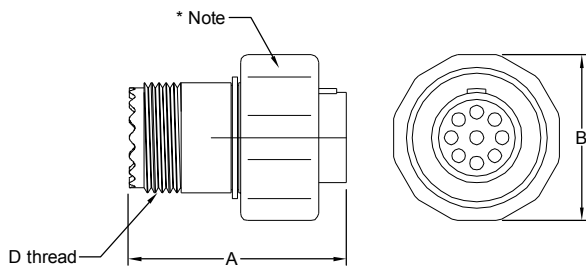

DIMENSION	SIZE 11 HOUSING	SIZE 19 HOUSING
A	1.165 [29.59]	1.165 [29.59]
B	0.890 [22.61]	1.435 [36.45]
D Thread	M15	M28

NOTE:
This connector may be ordered without the coupling nut.

RECEPTACLE HOUSING, MALE OR FEMALE CONTACTS

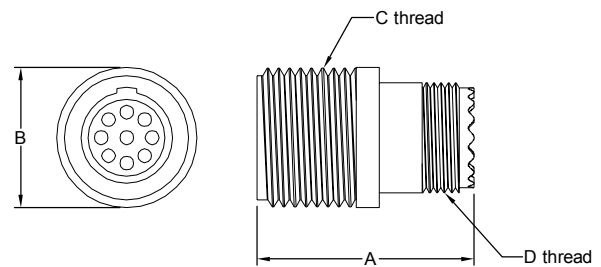

DIMENSION	SIZE 11 HOUSING	SIZE 19 HOUSING
A	1.165 [29.59]	1.165 [29.59]
B	ø 0.750 [19.05]	ø 1.181 [30.00]
C Thread	M19	M32
D Thread	M15	M28

MATERIALS:

Insert: Glass-filled DAP.

Housing & Coupling Nut: Glass-filled polyester.

FIXED JAM NUT MOUNTING RECEPTACLE HOUSING, MALE OR FEMALE CONTACTS

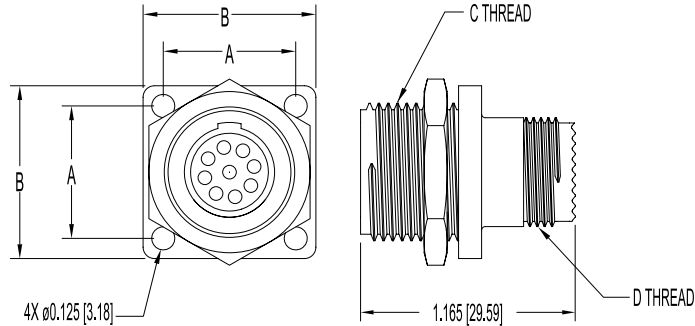

DIMENSION	SIZE 11 HOUSING	SIZE 19 HOUSING
A	0.719 [18.26]	1.062 [26.97]
B	0.938 [23.83]	1.438 [36.53]
C Thread	M19	M32
D Thread	M15	M28

MATERIALS AND FINISHES:

Insert: Glass-filled DAP.
Housing: Glass-filled polyester.
Jam Nut: Aluminum, black anodize.

DIMENSIONS

IN-LINE TO IN-LINE MOUNTING LENGTH OF MATED PAIR

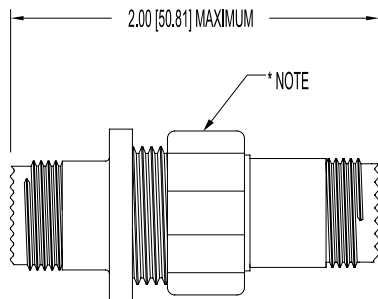

MATERIALS:

Insert: Glass-filled DAP.
Housing & Coupling Nut: Glass-filled polyester.

NOTE:
 This connector may be ordered without the coupling nut.

CONTACT HOLE DIAMETER TERMINATION SIDE OF INSULATOR

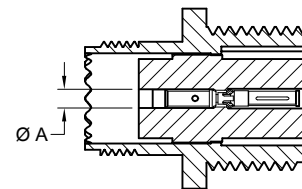

CONTACT SIZE	Ø D
12	0.195 [4.95]
16	0.125 [3.18]
20	0.097 [2.46]
22	0.079 [2.01]



Positronic
connectpositronic.com

STRAIGHT AND 90° PRINTED BOARD CONNECTORS

Front
Runner

STRAIGHT PRINTED BOARD MOUNT CONNECTOR RECEPTACLE HOUSING, MALE OR FEMALE CONTACTS

CONTACT SIZE	Ø D
12	0.094 [2.39]
16	0.035 [0.89]
20	0.028 [0.71]
22	0.025 [0.64]

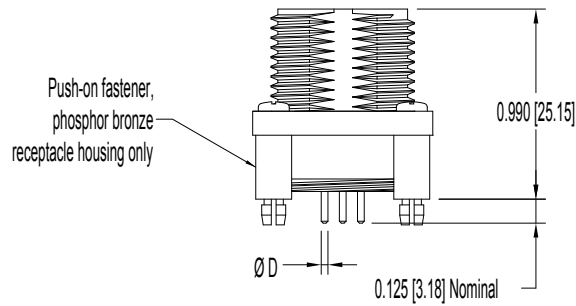

Typical Part Number:
FR11FF316K0-1554.0

DIMENSIONS

90° PRINTED BOARD MOUNT CONNECTOR

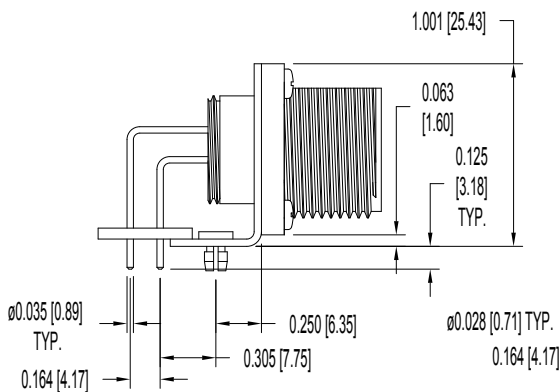

Typical Part Number:
FR11FF316K0-1553.0

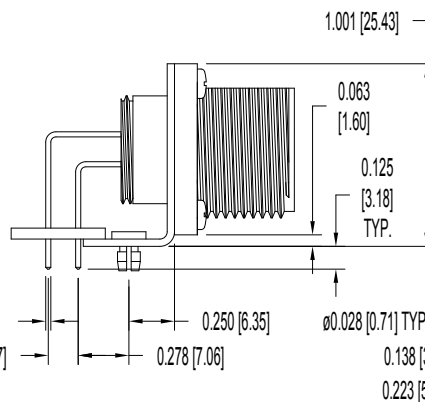

Typical Part Number:
FR11FF420K0-1553.0

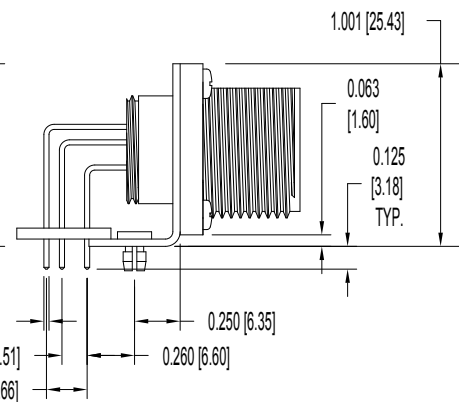

Typical Part Number:
FR11FF520K0-1553.0

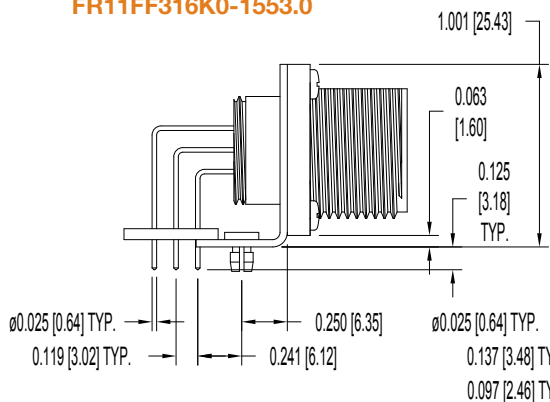

Typical Part Number:
FR11FF722K0-1553.0

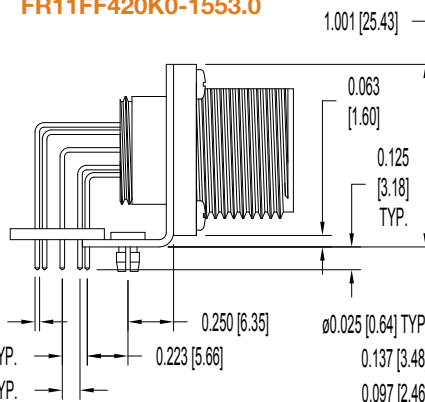

Typical Part Number:
FR11FF822K0-1553.0

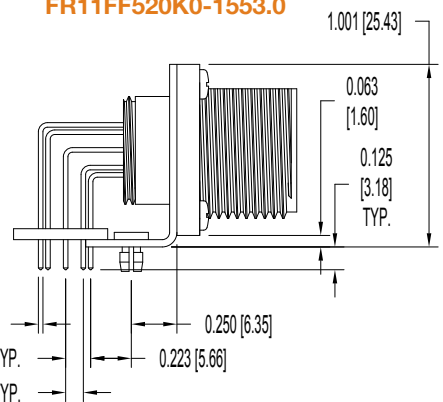

Typical Part Number:
FR11FF922K0-1553.0

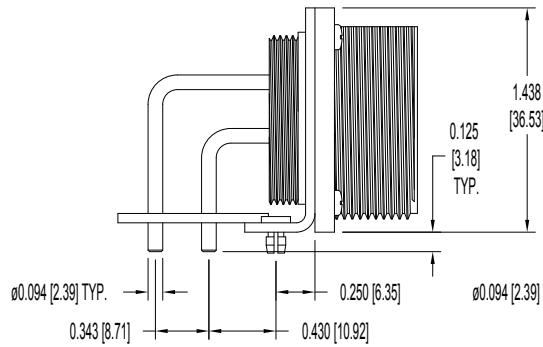

Typical Part Number:
FR19FF312K0-1553.0

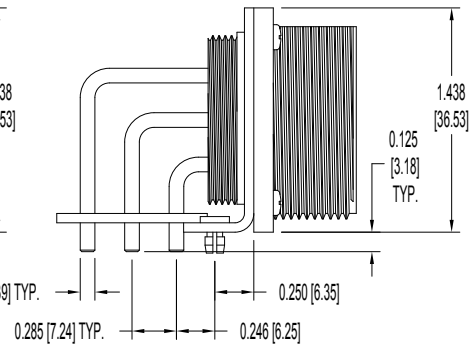

Typical Part Number:
FR19FF512K0-1553.0

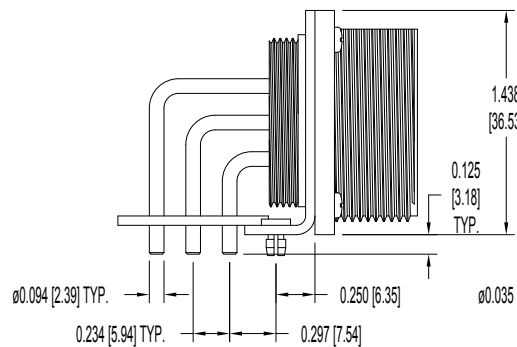

Typical Part Number:
FR19FF712K0-1553.0

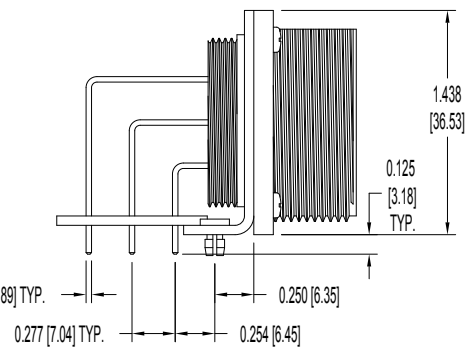

Typical Part Number:
FR19FF716K0-1553.0

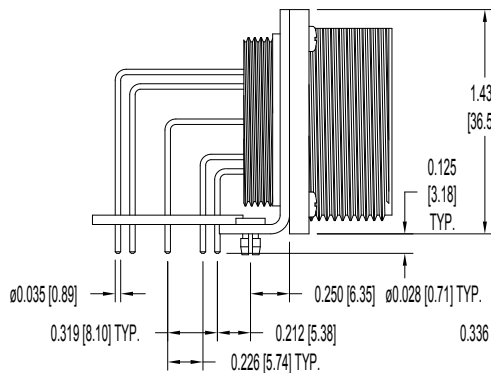

Typical Part Number:
FR19FF916K0-1553.0

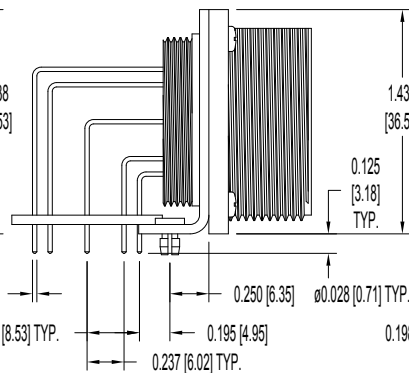

Typical Part Number:
FR19FF920K0-1553.0

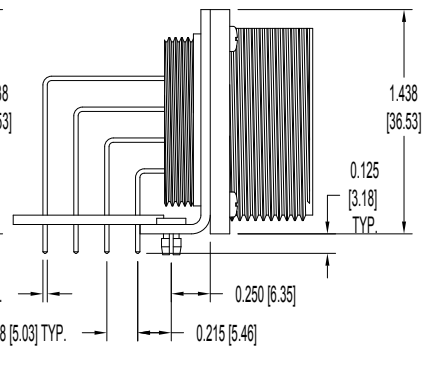

Typical Part Number:
FR19FF1220K0-1553.0

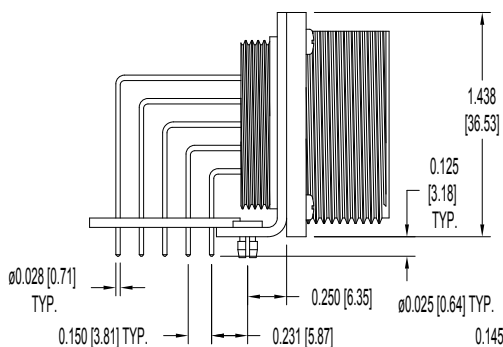

Typical Part Number:
FR19FF1920K0-1553.0

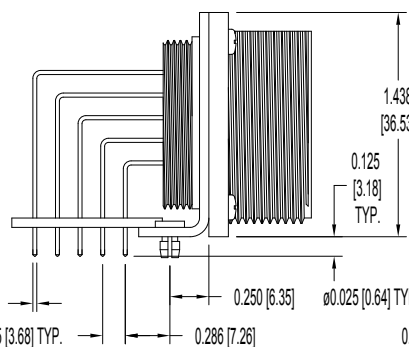

Typical Part Number:
FR19FF1822K0-1553.0

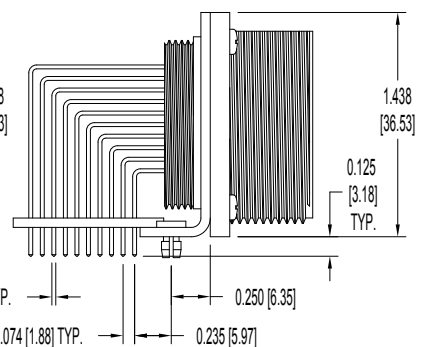

Typical Part Number:
FR19FF2922K0-1553.0



Positronic
connectpositronic.com

STRAIGHT PRINTED BOARD CONTACT HOLE PATTERN

Front
Runner

SUGGESTED PRINTED BOARD HOLE SIZES:

Suggest $\varnothing 0.114$ [2.90] plated through hole for size 12 contact termination positions.

Suggest $\varnothing 0.052$ [1.32] plated through hole for size 16 contact termination positions.

Suggest $\varnothing 0.045$ [1.14] plated through hole for size 20 contact termination positions.

Suggest $\varnothing 0.040$ [1.02] plated through hole for size 22 contact termination positions.

Suggest $\varnothing 0.123 \pm 0.003$ [3.12 \pm 0.08] hole for mounting connector with push-on fasteners.

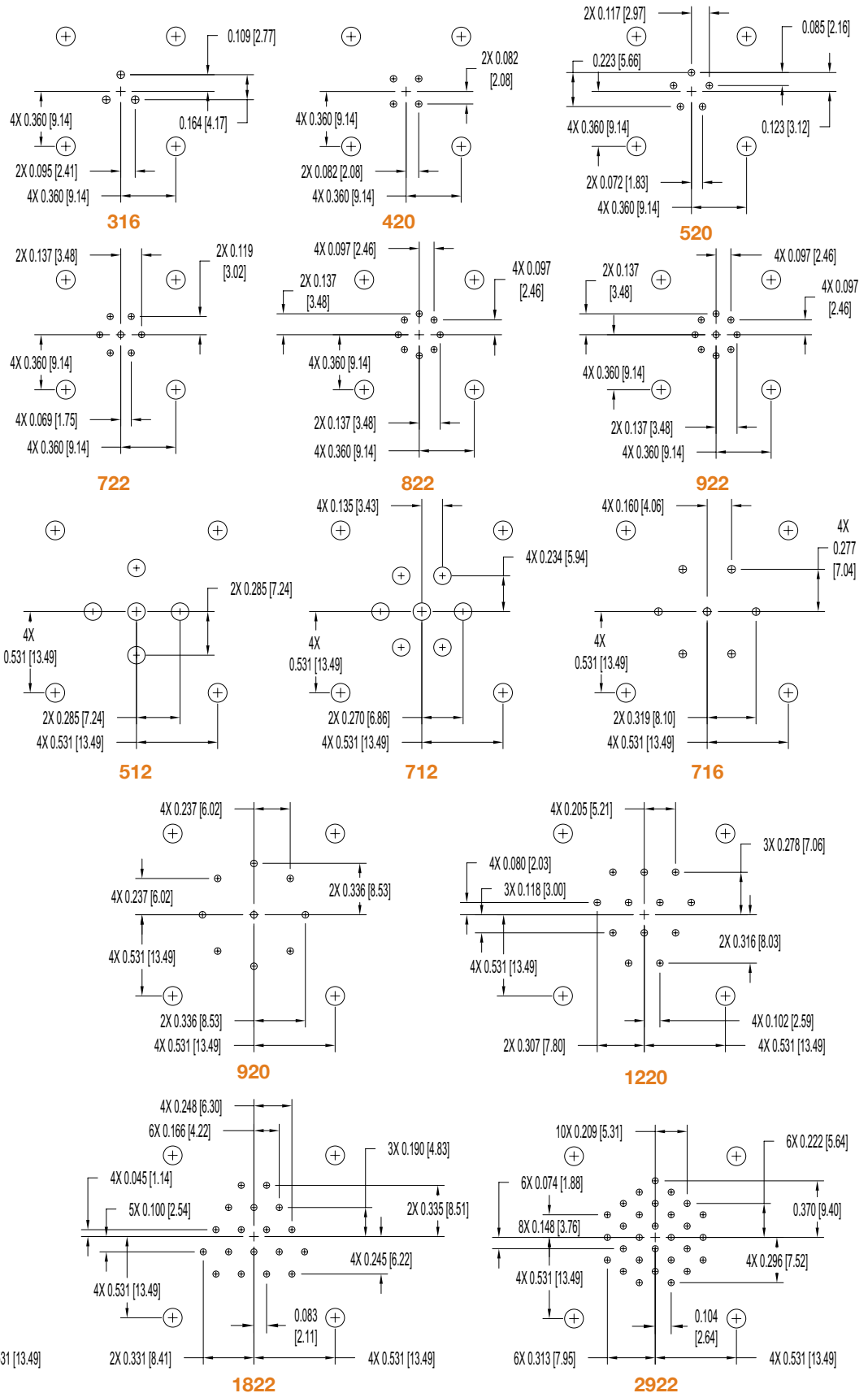

DIMENSIONS



SUGGESTED PRINTED BOARD HOLE SIZES:

Suggest \varnothing 0.114 [2.90] plated through hole for size 12 contact termination positions.

Suggest \varnothing 0.052 [1.32] plated through hole for size 16 contact termination positions.

Suggest \varnothing 0.045 [1.14] plated through hole for size 20 contact termination positions.

Suggest \varnothing 0.040 [1.02] plated through hole for size 22 contact termination positions.

Suggest \varnothing 0.123±0.003 [3.12±0.08] hole for mounting connector with push-on fasteners.

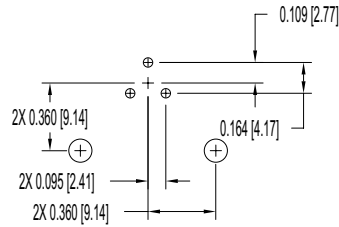

316

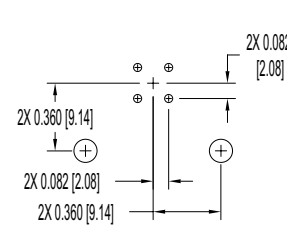

420

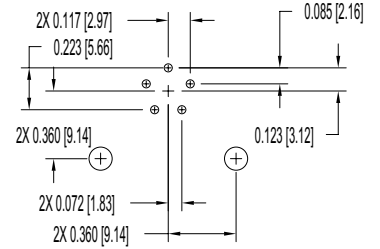

520

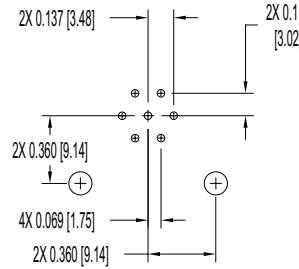

722

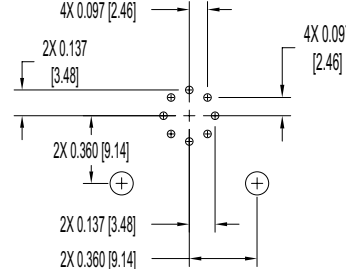

822

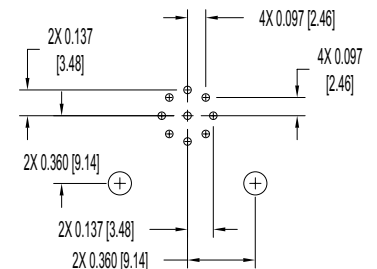

922

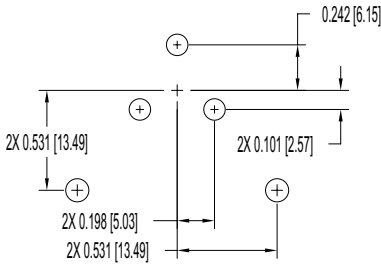

312

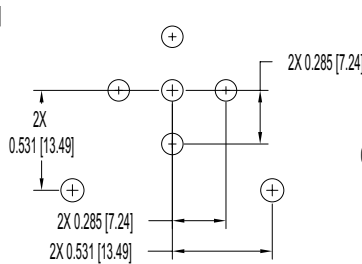

512

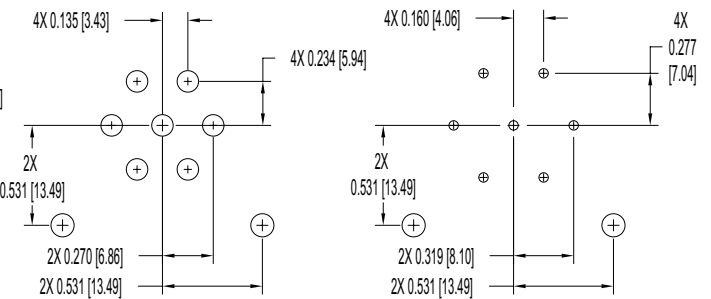

712

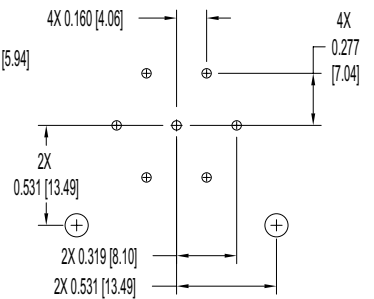

716

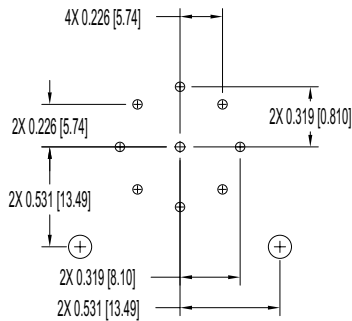

916

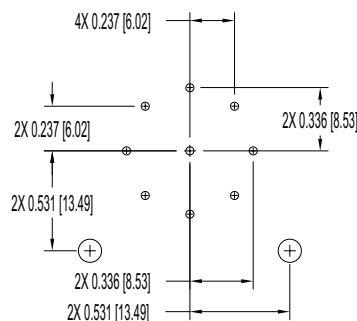

920

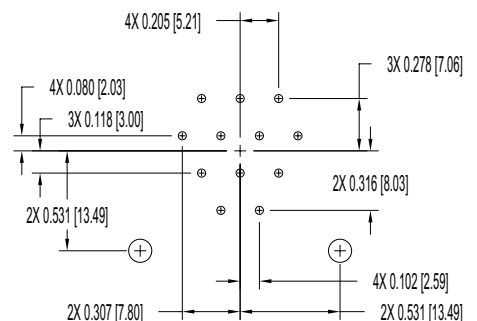

1220

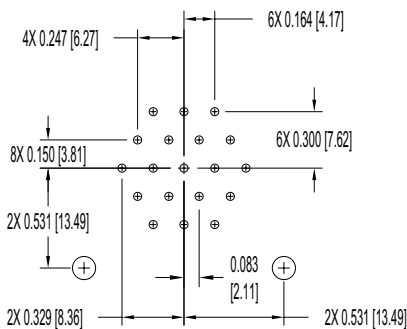

1920

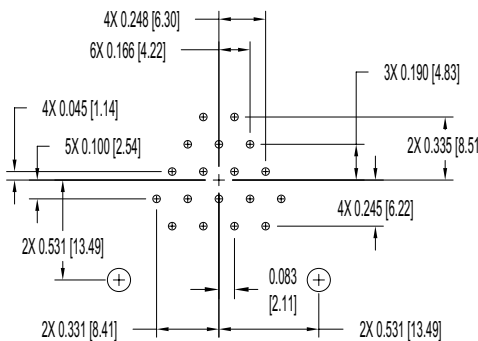

1822

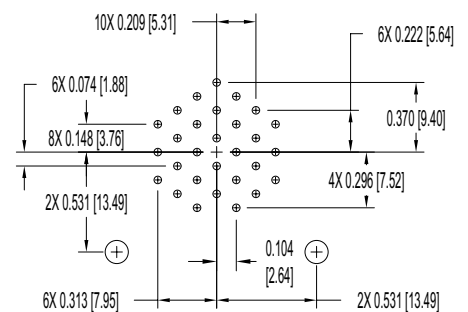

2922

DIMENSIONS



ORDERING INFORMATION - CODE NUMBERING SYSTEM

Specify Complete Connector By Selecting An Option From Step 1 Through 6

STEP	1	2	3	4	5	6	7	8
EXAMPLE	FR	11	MF	922	K	0	/AA	-1554.0

STEP 1 - BASIC SERIES

FR - Front Runner Series

STEP 2 - HOUSING SIZE

11 - Size 11 Housing
19 - Size 19 Housing

STEP 3 - HOUSING STYLE AND GENDER

MP - Free In-line, Male Contacts with Plug Housing
FP - Free In-line, Female Contacts with Plug Housing
MF - Fixed Flange Mount, Male Contacts with Receptacle Housing
FF - Fixed Flange Mount, Female Contacts with Receptacle Housing
MJ - Fixed Jam Nut, Male Contacts with Receptacle Housing
FJ - Fixed Jam Nut, Female Contacts with Receptacle Housing
MR - Free In-line, Male Contacts with Receptacle Housing
FR - Free In-line, Female Contacts with Receptacle Housing

STEP 4 - CONTACT ARRANGEMENTS AND SIZE

SIZE 11 HOUSING

316 - Three (3) Size 16 Contacts
420 - Four (4) Size 20 Contacts
520 - Five (5) Size 20 Contacts
722 - Seven (7) Size 22 Contacts
822 - Eight (8) Size 22 Contacts
922 - Nine (9) Size 22 Contacts

SIZE 19 HOUSING

312 - Three (3) Size 12 Contacts
512 - Five (5) Size 12 Contacts
712 - Seven (7) Size 12 Contacts
716 - Seven (7) Size 16 Contacts
916 - Nine (9) Size 16 Contacts
920 - Nine (9) Size 20 Contacts
1220 - Twelve (12) Size 20 Contacts
1822 - Eighteen (18) Size 22 Contacts
1920 - Nineteen (19) Size 20 Contacts
2922 - Twenty-nine (29) Size 22 Contacts

STEP 5 - SERVICE CLASS

K - Non-Environmental
L - Environmental
M - EMI/RFI Shielded
LM - Environmental and EMI/RFI Shielded

Note: Crimp contacts must be ordered separately. Select desired contact size and wire gauge size from pages 18 - 19.

Order thermocouple contacts from page 20.
Order size 16 micro-coaxial contacts from page 22.

STEP 8 - SPECIAL OPTIONS

FOR SPECIAL OPTIONS, SEE SPECIAL OPTIONS APPENDIX ON PAGE 13.

STEP 7 - ENVIRONMENTAL COMPLIANCE OPTIONS

/AA - Compliant per EU Directive 2002/95/EC (RoHS)

Note: If compliance to environmental legislation is not required, this step will not be used. Example: FR11MP922K1



STEP 6 - CABLE ADAPTERS (HOOD)

- 0 - None
- 1 - Long, Straight, Non-Environmental
- 2 - Short, Straight, Non-Environmental
- 4 - Long, Straight, Environmental
- 41- Long, Straight, Environmental with single cable seal. (Size 11 - 0.150 [3.81] ID, size 19 - 0.345 [8.76] ID)
- 42- Long, Straight, Environmental with single cable seal. (Size 11 - 0.200 [5.08] ID, size 19 - 0.420 [10.67] ID)
- 43- Long, Straight, Environmental with single cable seal. (Size 11 - 0.250 [6.35] ID, size 19 - 0.495 [12.57] ID)
- 44- Long, Straight, Environmental with single cable seal. (Size 11 - 0.300 [7.62] ID, size 19 - 0.570 [14.48] ID)
- 5 - Long, Straight, EMI/RFI
- 6 - Short, Straight, EMI/RFI

NOTE: Once you have made a connector selection, contact Technical Sales if you would like to receive a drawing in DXF, PDF format or a 3-dimensional IGES, STEP, or SOLIDWORKS file.

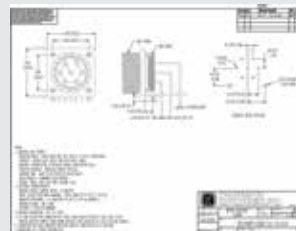

2-dimensional drawing

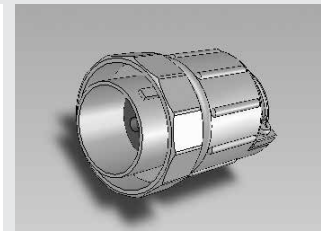

3-dimensional model



MODIFICATIONS (MOS)

Specify complete connector by selecting a base part number from the **Ordering Information Page**.
Once base part number is selected, add desired modification (MOS) number below to the end of the part number.

Example part number: FR19FR916K0-14-1553.0

HOUSING SIZE	GENDER	HOUSING STYLE	MODIFICATION OF STANDARD (MOS) NUMBER	DESCRIPTION OF MODIFICATION
11 & 19	M / F	PLUG	-1512.0	Allows for connector to be supplied without the coupling nut and associated retainer ring.
11 & 19	M / F	FIXED FLANGE MOUNT RECEPTACLE	-1553.0	Allows for connector be to supplied with right angle (90°) printed board mount termination contacts that allow for a 0.125 [3.18] tail length.
11 & 19	M / F	FIXED FLANGE MOUNT RECEPTACLE	-1554.0	Allows for connector to be supplied with straight printed board mount termination contacts that allow for a 0.125 [3.18] tail length. Push-on fasteners included.
11 & 19	M / F	ALL	-14	Allows connector with signal contacts installed, for signal contacts only to be plated 0.000030 [0.76µ] gold over nickel.
11 & 19	M / F	ALL	-15	Allows connector with signal contacts installed, for signal contacts only to be plated 0.000050 [1.27µ] gold over nickel.

MANY OTHER SPECIAL OPTIONS ARE AVAILABLE.

Find out more about Sequential Mating System,
Straight and Right Angle Thermocouple Printed Circuit Board mount contacts.

CONSULT TECHNICAL SALES OR VISIT OUR WEBSITE AS WWW.CONNECTPOSITRONIC.COM

ORDERING INFO



CABLE ADAPTERS

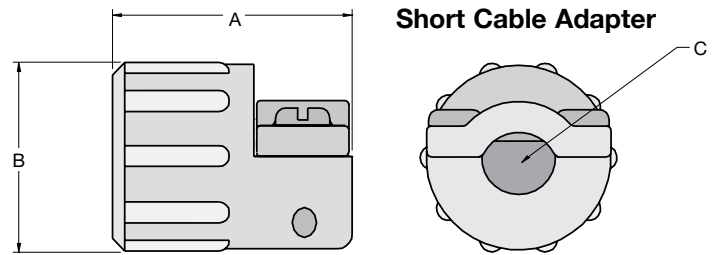
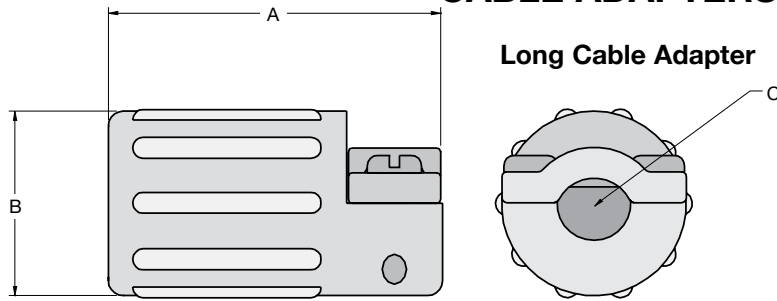

MATERIALS:

Cable Adapter & Cable Clamp: Glass-filled polyester.

DIMENSIONS	LONG CABLE ADAPTER			SHORT CABLE ADAPTER		
	A	B	C Cable Range	A	B	C Cable Range
Size 11 Housing	1.350 [34.29]	0.750 [19.05]	0.300 [7.62] Maximum	0.975 [24.77]	0.750 [19.05]	0.300 [7.62] Maximum
Size 19 Housing	1.350 [34.29]	1.285 [32.64]	0.570 [14.48] Maximum	0.975 [24.77]	1.285 [32.64]	0.570 [14.48] Maximum

MOLDED CABLE ASSEMBLY

Shell size 11 shown in drawing. Size 19 also available.

CONTACT TECHNICAL SALES FOR ORDERING INFORMATION.

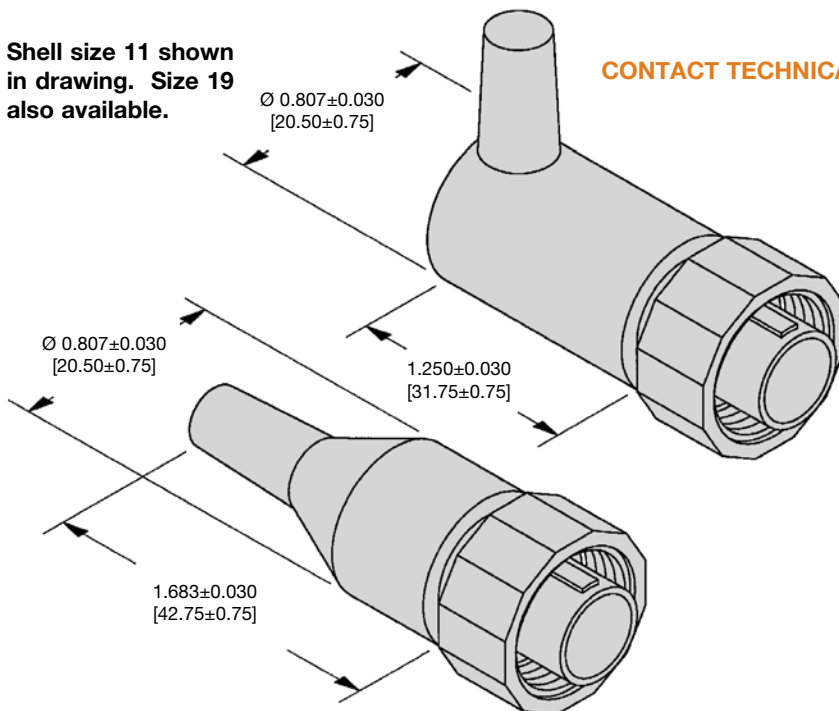

KEYING PLUGS

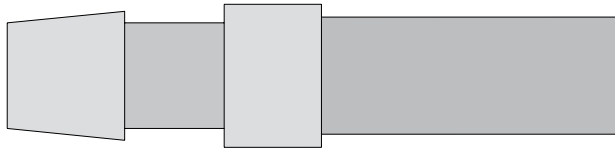

Keying Plug

MATERIAL: Nylon.

CONTACT SIZE	KEYING PLUG PART NUMBER
SIZE 12	5123-1-0-0
SIZE 16	5123-2-0-0
SIZE 20	5123-3-0-0
SIZE 22	5123-4-0-0

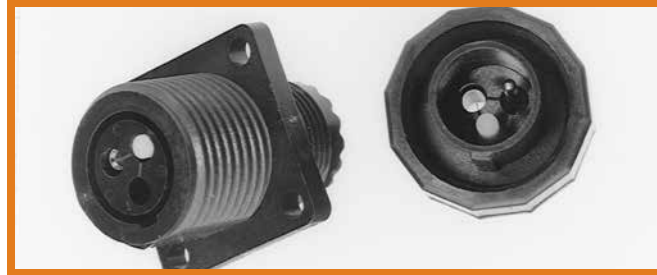

PRESS-ON DUST COVERS

PART NUMBER
5125-11-2-0 for Size 11 Connector
5125-19-2-0 for Size 19 Connector

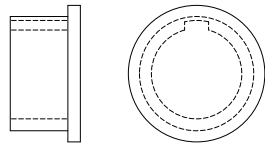

Use with Plug Shell

MATERIAL: Low density polyethylene.

THREADED DUST COVERS

PART NUMBER	THREAD
5125-11-0-0 for Size 11 Connector	M19
5125-19-0-0 for Size 19 Connector	M32

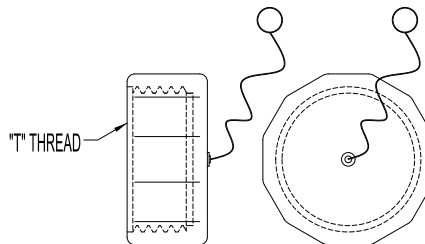

Use with Receptacle Shell

MATERIAL: Glass-filled polyester.

PART NUMBER
5125-11-1-0 for Size 11 Connector
5125-19-1-0 for Size 19 Connector

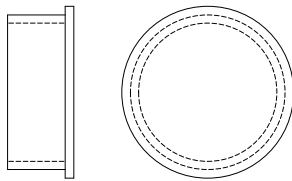

Use with Receptacle Shell



PANEL MOUNTING CUTOUTS

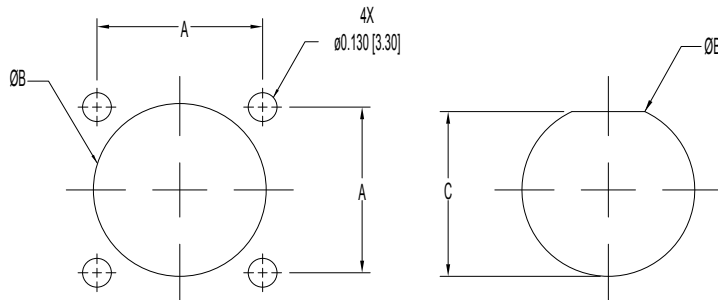

Flange Mounting

Jam Nut

Suggest 0.092 [2.34] maximum panel thickness if using environmental flange gasket or 0.122 [3.10] maximum panel thickness without gasket.

DIMENSION	SIZE 11 HOUSING	SIZE 19 HOUSING
A	0.719 [18.26]	1.062 [26.97]
Ø B	0.760 ±0.003 [19.30 ±0.08]	1.275 ±0.003 [32.39 ±0.08]
C	0.715 ±0.003 [18.16 ±0.08]	1.227 ±0.003 [31.17 ±0.08]



ENVIRONMENTAL DESIGN FEATURES

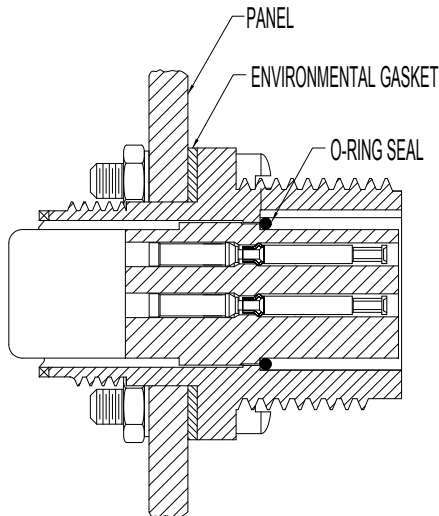

Fixed Female Flange Mounted Connector

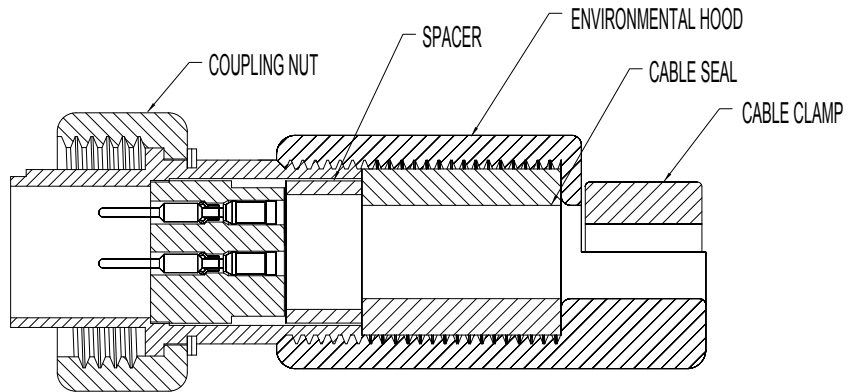

Free Male In-line Connector

MATERIALS:

O-Ring: Thermoplastic elastomer.

ENVIRONMENTAL VERSION ACCESSORIES

NOTE:

Environmental flange gaskets supplied with flange mount environmental connectors. Part numbers are shown for replacement parts only.

Environmental Cable Adapter Assembly Male or Female, Free In-Line Connectors

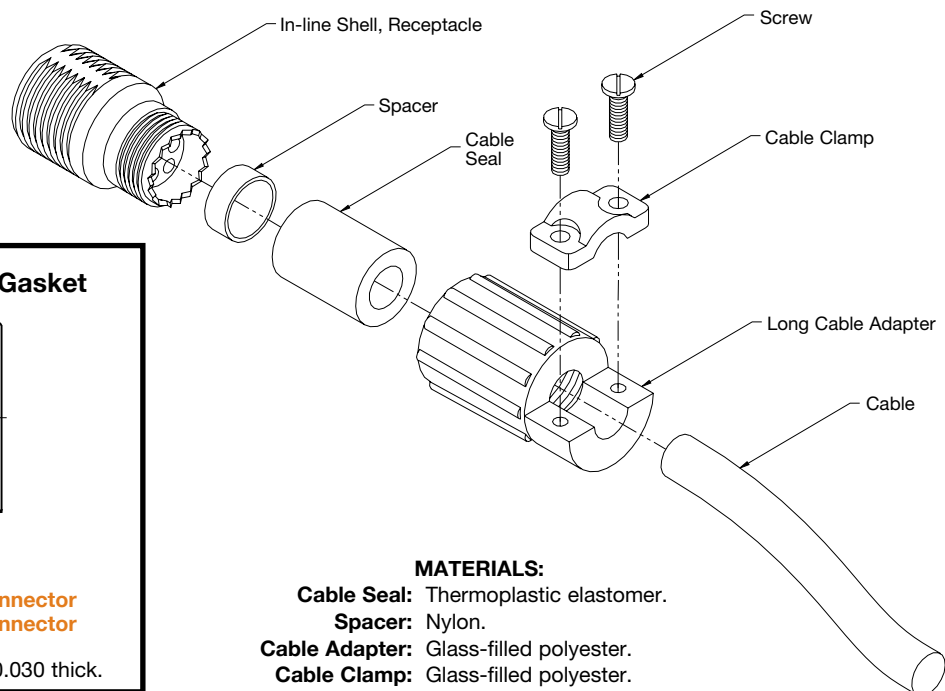

MATERIALS:

Cable Seal: Thermoplastic elastomer.
Spacer: Nylon.
Cable Adapter: Glass-filled polyester.
Cable Clamp: Glass-filled polyester.

Environmental Flange Gasket

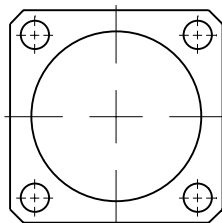

PART NUMBER:

5124-11-0-0 for Size 11 Connector
5124-19-0-0 for Size 19 Connector

MATERIAL: Neoprene sheet, 0.030 thick.

TECHNICAL DATA



MATERIAL: Electroless nickel over copper. Electroless plating offers surface conductivity of < 0.5 ohm per square and attenuation of 70-80 dB at most frequencies. Due to differences in cable construction and termination, results may vary and should be tested under actual operating conditions to determine exact values.

☛ **NOTE:** Dimensions are consistent with non-shielded versions.



SIZE 12 REMOVABLE CONTACTS

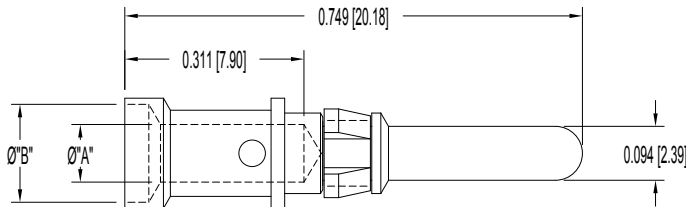

MALE

MALE CONTACT PART NUMBER	WIRE SIZE AWG [mm ²]	Ø "A"	Ø "B"
MC612N	12 [4.0]	0.100 [2.54]	0.170 [4.32]

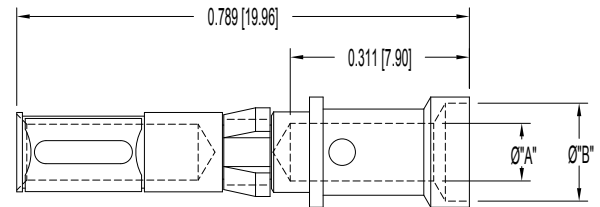

FEMALE

FEMALE CONTACT PART NUMBER	WIRE SIZE AWG [mm ²]	Ø "A"	Ø "B"
FC612N2	12 [4.0]	0.100 [2.54]	0.170 [4.32]

MATERIALS AND FINISHES:

Material: Copper Alloy.

Finish: Gold flash over nickel.

0.000030 inch [0.76 µ] gold over nickel available by adding "-14" suffix onto the part number. Example: MC612N-14.

SIZE 16 REMOVABLE CONTACTS

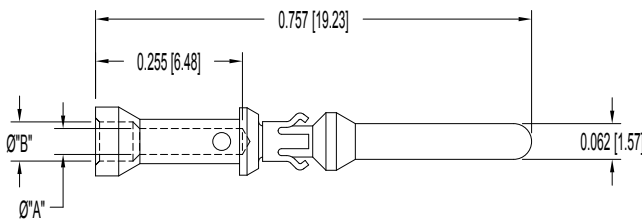

MALE

MALE CONTACT PART NUMBER	WIRE SIZE AWG [mm ²]	Ø "A"	Ø "B"
MC114N	14 / 16 [2.5 / 1.5]	0.081 [2.06]	0.105 [2.67]
MC116N	16 / 18 [1.5 / 1.0]	0.067 [1.70]	0.093 [2.36]
MC120N	20 / 22 / 24 [0.5 / 0.3 / 0.25]	0.045 [1.14]	0.065 [1.65]

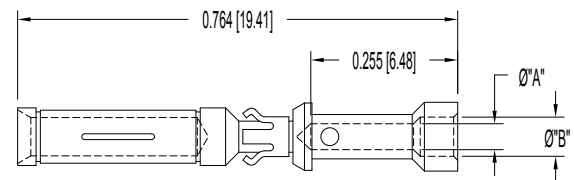

FEMALE

FEMALE CONTACT PART NUMBER	WIRE SIZE AWG [mm ²]	Ø "A"	Ø "B"
FC114N2	14 / 16 [2.5 / 1.5]	0.081 [2.06]	0.105 [2.67]
FC116N2	16 / 18 [1.5 / 1.0]	0.067 [1.70]	0.093 [2.36]
FC120N2	20 / 22 / 24 [0.5 / 0.3 / 0.25]	0.045 [1.14]	0.065 [1.65]

MATERIALS AND FINISHES:

Material: Copper Alloy.

Finish: Gold flash over nickel.

0.000030 inch [0.76 µ] gold over nickel available by adding "-14" suffix onto the part number. Example: FC612N-14.



SIZE 20 REMOVABLE CONTACTS

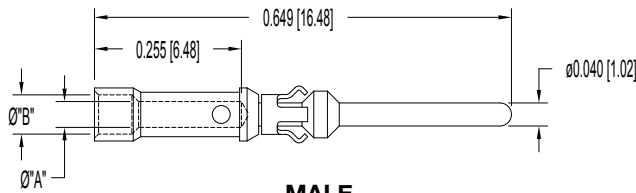

MALE

MALE CONTACT PART NUMBER	WIRE SIZE AWG [mm ²]	Ø "A"	Ø "B"
MC720N3	20 / 22 / 24 [0.5 / 0.3 / 0.25]	0.045 [1.14]	0.068 [1.73]

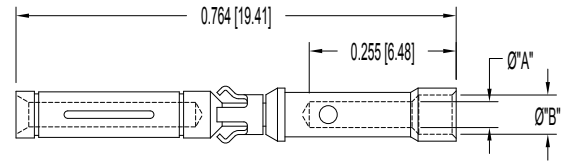

FEMALE

FEMALE CONTACT PART NUMBER	WIRE SIZE AWG [mm ²]	Ø "A"	Ø "B"
FC720N2	20 / 22 / 24 [0.5 / 0.3 / 0.25]	0.045 [1.14]	0.068 [1.73]

MATERIALS AND FINISHES:

Material: Copper Alloy.

Finish: Gold flash over nickel.

0.000030 inch [0.76 µ] gold over nickel available by adding "-14" suffix onto the part number. Example: FC720N2-14.

SIZE 22 REMOVABLE CONTACTS

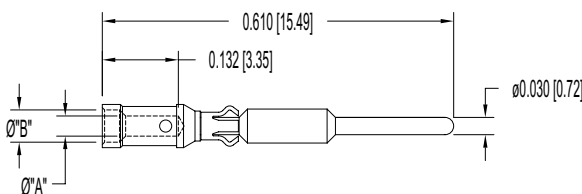

MALE

MALE CONTACT PART NUMBER	WIRE SIZE AWG [mm ²]	Ø "A"	Ø "B"
MC422N	22 / 24 / 26 [0.3 / 0.25 / 0.12]	0.035 [0.89]	0.056 [1.42]

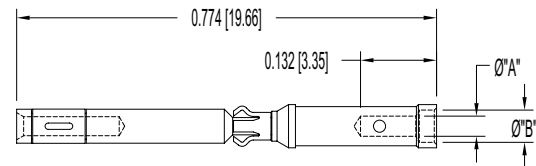

FEMALE

FEMALE CONTACT PART NUMBER	WIRE SIZE AWG [mm ²]	Ø "A"	Ø "B"
FC422N6	22 / 24 / 26 [0.3 / 0.25 / 0.12]	0.035 [0.89]	0.056 [1.42]

MATERIALS AND FINISHES:

Material: Copper Alloy.

Finish: Gold flash over nickel.

0.000030 inch [0.76 µ] gold over nickel available by adding "-14" suffix onto the part number. Example: MC422N-14.

ADVANTAGES OF REAR INSERTION-FRONT RELEASE CONTACT RETENTION SYSTEM

CONSIDERATION	FRONT RELEASE ADVANTAGE
1. Size	Will accept a wire with oversized insulation diameter.
2. Connector Wiring	Less open wiring is required between the connector and the lacing or between the connector and the cable jacket. Minimum service time is required for repairs.
3. Shielded Wires	Provides the most effective RFI shielding as the shielding can be brought closer to the grommet surface for terminations to the connector shell.
4. Contact Servicing	Since the removal tool is inserted from the front, finding the correct position is relatively simple.
5. Wire Breakage	The standard removal tool can be used to remove a contact which has a broken wire at the contact crimp joint.
6. Service Tools	Metal tools are available for inserting and removing contacts.



SIZE 20 CRIMP THERMOCOUPLE CONTACTS

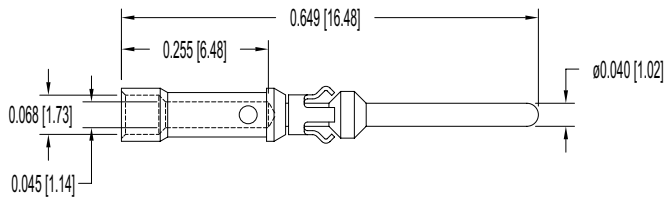

MALE

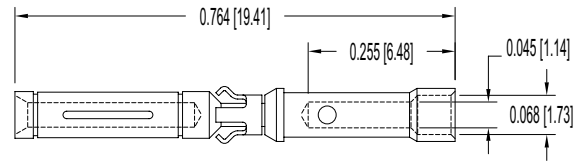

FEMALE

TYPE	MATERIAL	MALE PART NUMBER	FEMALE PART NUMBER	COLOR CODE	WIRE SIZE AWG [mm ²]
K	CHROMEL (+)	MC720N3CH	FC720N2CH	WHITE	20 / 22 / 24 [0.5 / 0.3 / 0.25]
	ALUMEL (-)	MC720N3AL	FC720N2AL	GREEN	20 / 22 / 24 [0.5 / 0.3 / 0.25]
T	COPPER (+)	MC720N3CU	FC720N2CU	RED	20 / 22 / 24 [0.5 / 0.3 / 0.25]
	CONSTANTAN (-)	MC720N3CO	FC720N2CO	YELLOW	20 / 22 / 24 [0.5 / 0.3 / 0.25]
E	CHROMEL (+)	MC720N3CH	FC720N2CH	WHITE	20 / 22 / 24 [0.5 / 0.3 / 0.25]
	CONSTANTAN (-)	MC720N3CO	FC720N2CO	YELLOW	20 / 22 / 24 [0.5 / 0.3 / 0.25]

For more information on the availability of Type J thermocouple contacts, please contact Technical Sales.

For more information about thermocouple contacts with PCB solder termination, please contact Technical Sales.

See page 24 for Crimp Tool information.

Chromel® and Alumel® are registered trademarks of Hoskins Manufacturing Company

SIZE 22 CRIMP THERMOCOUPLE CONTACTS

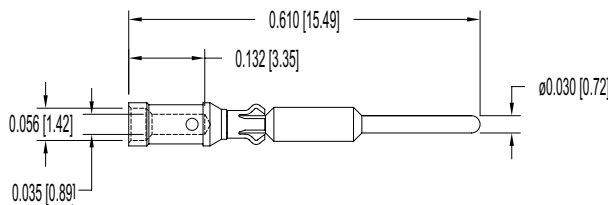

MALE

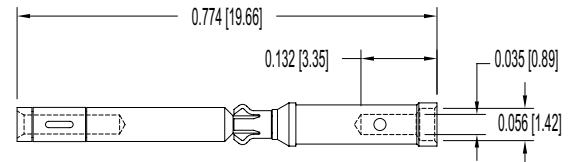

FEMALE

TYPE	MATERIAL	MALE PART NUMBER	FEMALE PART NUMBER	COLOR CODE	WIRE SIZE AWG [mm ²]
K	CHROMEL (+)	MC422NCH	FC422N6CH	WHITE	22 / 24 / 26 [0.3 / 0.25 / 0.12]
	ALUMEL (-)	MC422NAL	FC422N6AL	GREEN	22 / 24 / 26 [0.3 / 0.25 / 0.12]
T	COPPER (+)	MC422NCU	FC422N6CU	RED	22 / 24 / 26 [0.3 / 0.25 / 0.12]
	CONSTANTAN (-)	MC422NCO	FC422N6CO	YELLOW	22 / 24 / 26 [0.3 / 0.25 / 0.12]
E	CHROMEL (+)	MC422NCH	FC422N6CH	WHITE	22 / 24 / 26 [0.3 / 0.25 / 0.12]
	CONSTANTAN (-)	MC422NCO	FC422N6CO	YELLOW	22 / 24 / 26 [0.3 / 0.25 / 0.12]

For more information on the availability of Type J thermocouple contacts, please contact Technical Sales.

For more information about thermocouple contacts with PCB solder termination, please contact Technical Sales.

See page 24 for Crimp Tool information.

Chromel® and Alumel® are registered trademarks of Hoskins Manufacturing Company

SIZE 12 CRIMP SHIELDED CONTACTS

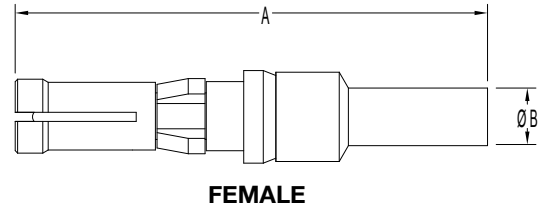
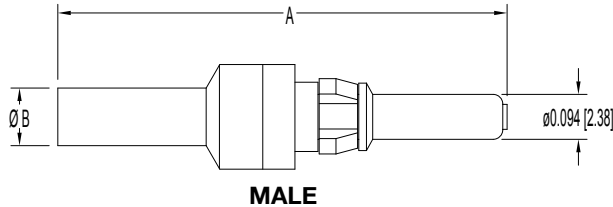

CONTACT DESIGNATION	PART NUMBER	A	Ø B	CABLE SIZE
MALE	MC601D	0.936 [23.77]	0.041 [1.04]	RG 178 B/U RG 196 B/U
FEMALE	FC601D	0.984 [24.99]	0.041 [1.04]	RG 178 B/U RG 196 B/U
MALE	MC602D	0.936 [23.77]	0.070 [1.78]	RG 179 B/U RG 316 /U
FEMALE	FC602D	0.984 [24.99]	0.070 [1.78]	RG 179 B/U RG 316 /U

TECHNICAL CHARACTERISTICS

MATERIALS AND FINISHES:

Insulating Material: (Dielectric) PTFE, Teflon.
Inner Contacts: Brass & Phosphor bronze, 0.000030 inch [0.76 microns] gold over nickel and 0.000050 inch [1.27 microns] gold over nickel.

Contact Body: Brass and Phosphor bronze, gold flash over nickel.

MECHANICAL CHARACTERISTICS:

Removable Contacts: Rear insertion, front release.
Durability: 100 cycles minimum.
Vibration: 20g from 10 HZ to 500 HZ.
Shock: 30g - 11rms.

ELECTRICAL CHARACTERISTICS:

Initial Contact Resistance: 0.010 ohms maximum.
Nominal Impedance: 50 ohms.
Insertion Loss: 0.35 dB at 1 GHz
 1.35 dB at 2 GHz
 1.53 dB at 3 GHz
VSWR: 1.20 average at 1 GHz
 1.45 average at 2 GHz
 1.63 average at 3 GHz
Proof Voltage: 600 V r.m.s.

Above values measured using frequency domain techniques.

CLIMATIC CHARACTERISTICS:

Temperature Range: -55°C to +125°C.

CRIMP TOOL

Use 9504-0-0-0 Crimp Tool

SHIELDED CABLE STRIP LENGTH

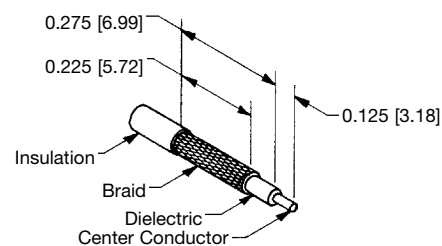



SIZE 16 CRIMP SHIELDED CONTACTS

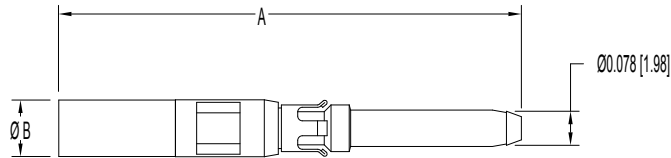

MALE

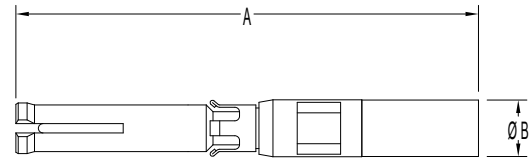

FEMALE

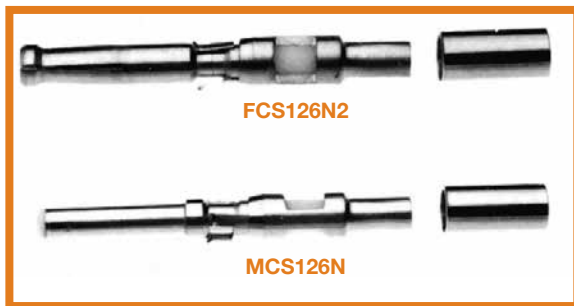

CONTACT DESIGNATION	PART NUMBER	A	Ø B	CABLE SIZE
MALE	MCS126N	0.993 [25.22]	0.045 [1.14]	RG 178 B/U RG 196 A/U
FEMALE	FCS126N2	0.967 [24.56]	0.045 [1.14]	RG 178 B/U RG 196 B/U
MALE	MCS226N	1.048 [26.62]	0.070 [1.78]	RG 179 B/U RG 316 /U
FEMALE	FCS226N2	1.022 [25.96]	0.070 [1.78]	RG 179 B/U RG 316 /U

TECHNICAL CHARACTERISTICS

MATERIALS AND FINISHES:

- Insulating Material:** (Dielectric) Teflon.
- Inner Contacts:** Phosphor bronze, 0.000030 inch [0.76 microns] gold over nickel.
- Outer Contacts:** Brass and beryllium copper, gold flash over nickel.

MECHANICAL CHARACTERISTICS:

- Contact Retention in Insulator:** 20 lbs. [89N].
- Removable Contacts:** Rear insertion, front removable.
- Insertion Force per Contact:** 8 oz. [2.2 N] per contact maximum.
- Durability:** 100 cycles minimum.
- Vibration:** 20g from 10 HZ to 500 HZ.
- Shock:** 30g - 11rms.

ELECTRICAL CHARACTERISTICS:

MICRO-COAXIAL CONTACTS	CONTACT/WIRE COMBINATIONS			
	126N		226N	
	RG178	RG196	RG179	RG316
Characteristic Impedance (ohms)	50	50	75	50
Frequency Range	0-500 MHz			
VSWR				
0 to 200 MHz	1.25			
200 to 500 MHz	1.70		2.25	
Insertion Loss @ 500 MHz	0.2 dB		1.0 dB	

- Dielectric Strength at Sea Level:** 600 V rms.
- Initial Contact Resistance:** 0.012 ohms maximum.
- Insulator Resistance:** 5 G ohms.

CLIMATIC CHARACTERISTICS:

- Temperature Range:** -55°C to +125°C



9506-0-0-0 CRIMP TOOL

SHIELDED CABLE STRIP LENGTH

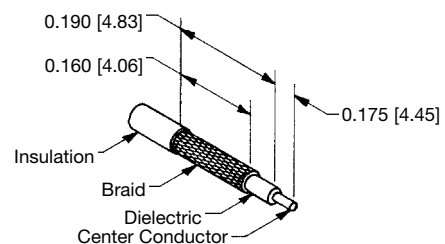



A P P L I C A T I O N T O O L S S E C T I O N

Front Runner connectors are offered with **removable crimp contacts**.



Positronic Industries recognizes the **importance of** supplying **application tooling** to support our customers' use of our products.

Information on application tooling is **available** on our web site at



<http://www.connectpositronic.com/products/157/ApplicationTooling>

There you will find **downloadable PDF** cross reference charts for removable contacts. These charts will **supply part numbers** for insertion, removal and crimping tools, along with **information regarding use** of tools and techniques.

Connectors Designed To Customer Specifications

Positronic **Front Runner** connectors can be modified to customer specifications.

Examples: select loading of contacts for cost savings or to gain creepage and clearance distances; longer printed circuit board terminations; customer specified hardware.

Contact Technical Sales with your particular requirements.



CONTACT APPLICATION TOOLS CROSS REFERENCE LIST

USE INDICATED POSITRONIC TOOLS FOR BEST RESULTS

Positronic Contact P/N	Contact Size	Handle & Positioner P/N	Hand Crimp Tool P/N	Mfg. Cross	Mill Equiv	Positioner	Mfg. Cross	Mill Equiv	Insertion Tool	Mfg. Cross	Mill Equiv	Removal Tool	Mfg. Cross	Mill Equiv
FC114N2		---	9501-0-0-0	AF8	M22520/1-01	9502-1-0-0	TH4	M22520/1-03	9099-0-0-0	ITH 1094	M81969/18-01	9081-4-0-0	RTG 2103	M81969/20-01
FC116N2	16	---	9501-0-0-0	AF8	M22520/1-01	9502-1-0-0	TH4	M22520/1-03	9099-0-0-0	ITH 1094	M81969/18-01	9081-4-0-0	RTG 2103	M81969/20-01
FC120N2		---	9501-0-0-0	AF8	M22520/1-01	9502-1-0-0	TH4	M22520/1-03	9099-0-0-0	ITH 1094	M81969/18-01	9081-4-0-0	RTG 2103	M81969/20-01
FC422N6		---	9507-0-0-0	AFM8	M22520/2-01	9502-20-0-0	K1197	---	9099-1-0-0	ITH 1056	M81969/18-02	9081-3-0-0	RNG2103	---
FC422N6AL		---	9507-0-0-0	AFM8	M22520/2-01	9502-20-0-0	K1197	---	9099-1-0-0	ITH 1056	M81969/18-02	9081-3-0-0	RNG2103	---
FC422N6CH	22	---	9507-0-0-0	AFM8	M22520/2-01	9502-20-0-0	K1197	---	9099-1-0-0	ITH 1056	M81969/18-02	9081-3-0-0	RNG2103	---
FC422N6CO		---	9507-0-0-0	AFM8	M22520/2-01	9502-20-0-0	K1197	---	9099-1-0-0	ITH 1056	M81969/18-02	9081-3-0-0	RNG2103	---
FC422N6CU		---	9507-0-0-0	AFM8	M22520/2-01	9502-20-0-0	K1197	---	9099-1-0-0	ITH 1056	M81969/18-02	9081-3-0-0	RNG2103	---
FC601D		9504-0-0-0	9504-1-0-0	HX4	M22520/5-01	9504-2-0-0	Y322	---	9099-3-0-0	ITP 1168	---	2711-0-0-0	P+	---
FC602D	12	9504-0-0-0	9504-1-0-0	HX4	M22520/5-01	9504-2-0-0	Y322	---	9099-3-0-0	ITP 1168	---	2711-0-0-0	P+	---
FC612N2		---	9501-0-0-0	AF8	M22520/1-01	9502-19-0-0	TP1199	---	9099-3-0-0	ITP 1168	---	2711-0-0-0	P+	---
FC720N2		---	9507-0-0-0	AFM8	M22520/2-01	9502-22-0-0	K1196	---	9099-4-0-0	ITP 1076	---	9081-2-0-0	RNG2103	---
FC720N2AL		---	9507-0-0-0	AFM8	M22520/2-01	9502-22-0-0	K1196	---	9099-4-0-0	ITP 1076	---	9081-2-0-0	RNG2103	---
FC720N2CH	20	---	9507-0-0-0	AFM8	M22520/2-01	9502-22-0-0	K1196	---	9099-4-0-0	ITP 1076	---	9081-2-0-0	RNG2103	---
FC720N2CO		---	9507-0-0-0	AFM8	M22520/2-01	9502-22-0-0	K1196	---	9099-4-0-0	ITP 1076	---	9081-2-0-0	RNG2103	---
FC720N2CU		---	9507-0-0-0	AFM8	M22520/2-01	9502-22-0-0	K1196	---	9099-4-0-0	ITP 1076	---	9081-2-0-0	RNG2103	---
FC5126N2	16	9506-0-0-0	9506-1-0-0	HX3	---	9506-2-0-0	X530	---	9099-0-0-0	ITH 1094	---	9081-4-0-0	RTG 2103	M81969/20-01
FC5226N2	20	9506-0-0-0	9506-1-0-0	HX3	---	9506-2-0-0	X530	---	9099-0-0-0	ITH 1094	---	9081-4-0-0	RTG 2103	M81969/20-01
MC114N		---	9501-0-0-0	AF8	M22520/1-01	9502-1-0-0	TH4	M22520/1-03	9099-0-0-0	ITH 1094	M81969/18-01	9081-4-0-0	RTG 2103	M81969/20-01
MC116N	16	---	9501-0-0-0	AF8	M22520/1-01	9502-1-0-0	TH4	M22520/1-03	9099-0-0-0	ITH 1094	M81969/18-01	9081-4-0-0	RTG 2103	M81969/20-01
MC120N		---	9501-0-0-0	AF8	M22520/1-01	9502-1-0-0	TH4	M22520/1-03	9099-0-0-0	ITH 1094	M81969/18-01	9081-4-0-0	RTG 2103	M81969/20-01
MC422N		---	9507-0-0-0	AFM8	M22520/2-01	9502-12-0-0	K187	---	9099-1-0-0	ITH 1056	M81969/18-02	9081-1-0-0	RTCO 2061	---
MC422NAL		---	9507-0-0-0	AFM8	M22520/2-01	9502-12-0-0	K187	---	9099-1-0-0	ITH 1056	M81969/18-02	9081-1-0-0	RTCO 2061	---
MC422NCH	22	---	9507-0-0-0	AFM8	M22520/2-01	9502-12-0-0	K187	---	9099-1-0-0	ITH 1056	M81969/18-02	9081-1-0-0	RTCO 2061	---
MC422NCO		---	9507-0-0-0	AFM8	M22520/2-01	9502-12-0-0	K187	---	9099-1-0-0	ITH 1056	M81969/18-02	9081-1-0-0	RTCO 2061	---
MC422NCU		---	9507-0-0-0	AFM8	M22520/2-01	9502-12-0-0	K187	---	9099-1-0-0	ITH 1056	M81969/18-02	9081-1-0-0	RTCO 2061	---
MC601D		9504-0-0-0	9504-1-0-0	HX4	M22520/5-01	9504-2-0-0	Y322	---	9099-3-0-0	ITP 1168	---	2711-0-0-0	P+	---
MC602D	12	9504-0-0-0	9504-1-0-0	HX4	M22520/5-01	9504-2-0-0	Y322	---	9099-3-0-0	ITP 1168	---	2711-0-0-0	P+	---
MC612N		---	9501-0-0-0	AF8	M22520/1-01	9502-19-0-0	TP1199	---	9099-3-0-0	ITP 1168	---	2711-0-0-0	P+	---
MC720N3		---	9507-0-0-0	AFM8	M22520/2-01	9502-27-0-0	K1506	---	9099-4-0-0	ITP 1076	---	9081-2-0-0	RNG2103	---
MC720N3AL		---	9507-0-0-0	AFM8	M22520/2-01	9502-27-0-0	K1195	---	9099-4-0-0	ITP 1076	---	9081-2-0-0	RNG2103	---
MC720N3CH	20	---	9507-0-0-0	AFM8	M22520/2-01	9502-27-0-0	K1195	---	9099-4-0-0	ITP 1076	---	9081-2-0-0	RNG2103	---
MC720N3CO		---	9507-0-0-0	AFM8	M22520/2-01	9502-27-0-0	K1195	---	9099-4-0-0	ITP 1076	---	9081-2-0-0	RNG2103	---
MC720N3CU		---	9507-0-0-0	AFM8	M22520/2-01	9502-27-0-0	K1195	---	9099-4-0-0	ITP 1076	---	9081-2-0-0	RNG2103	---
MCS126N	16	9506-0-0-0	9506-1-0-0	HX3	---	9506-2-0-0	X530	---	9099-0-0-0	ITH 1094	M81969/18-01	9081-4-0-0	RTG 2103	M81969/20-01
MCS226N	20	9506-0-0-0	9506-1-0-0	HX3	---	9506-2-0-0	X530	---	9099-0-0-0	ITH 1094	M81969/18-01	9081-4-0-0	RTG 2103	M81969/20-01

For more listings see visit our web site to download a PDF file at <https://www.connectpositronic.com/tooling>

POSITRONIC CABLIZED CONNECTORS

SAVE TIME AND MONEY!

Let Positronic support you by cablizing your
Front Runner connector selection.

Cable Assembly Design Support

We work closely with customers to:

1. Design assemblies in accordance with customer specifications.
2. Prepare cablized connector configuration and performance specifications.
3. Design each system in accordance with applicable customer, domestic, and international standards.
4. Define and conduct performance and verification testing.



Technical Sales Support



Engineering Support



Quality Assurance



Puerto Rico Cable Assembly

FOR MORE DETAILS CONTACT **TECHNICAL SALES**
OR VISIT OUR **WEB SITE** AT:

**[HTTP://WWW.CONNECTPOSITRONIC.COM/
PRODUCTS/47/CABLEASSEMBLIES](http://www.connectpositronic.com/products/47/cableassemblies)**

OTHER CIRCULAR PRODUCTS

Positronic Industries offers a range of circular connectors in a variety of contact variants and package sizes with compliant press-in, solder and cable terminations. All Positronic connector products provide **high quality, reliability and flexibility.**



KING COBRA SERIES CONNECTORS

Offer the performance of high reliability machined contacts at a price you might expect from lower performance products.

- Lightweight, non-corrodible, composite material
- Right angle and straight PCB mount terminations
- Size 16, 20 and 22 machined contact options
- Power contact current ratings to 20 amperes each
- Environmental options to IP65
- Secured using unique one quarter turn locking system

BABY KING COBRA CONNECTORS

Miniature, rugged, economical

- Smaller package size than King Cobra
- Solder cup terminations
- Size 20 machined contacts
- Cable or panel mount options
- Environmental options to IP65
- Secured using unique one quarter turn locking system



CIRCLE HEX SERIES CONNECTORS

Ideal for use in industrial and instrumentation applications where light weight, miniature, high reliability interconnections are necessary.

- "Twist Spring" locking device
- Large, miniature, and microminiature sizes available
- Solid machined contacts for high reliability
- Available in straight solder and solder cup terminations
- Variety of cable adapters and contact variants
- Contact current ratings to 7.5 amperes nominal

Connector Excellence[®]

Positronic HIGH RELIABILITY Products

POWER



FEATURES:

- High current density • Energy saving - low contact resistance • Hot swap capability
- AC/DC operation in a single connector
- Signal contacts for hardware management • Blind mating • Sequential mating
- Large surface area contact mating system • Wide variety of accessories
- Customer-specified contact arrangements • Modular tooling which produces a single piece connector insert

Contact Sizes: 0, 8, 12, 16, 20, 22 and 24
To 200 amperes per contact

Current Ratings: Crimp and panel mount, straight solder, right angle (90°) solder, straight compliant press-in and right angle (90°) compliant press-in

Terminations: Multiple variants in a variety of package sizes

Configurations: PICMG 2.11, PICMG 3.0, VITA 41, DESC, GSFC S-311-P-4, GSFC S-311-P-10

Compliance:

D - SUB MINIATURE



FEATURES:

- Four performance levels available for best cost/performance ratio: professional, industrial, military and space-flight quality
- Options include high voltage, coax, thermocouple and air coupling contacts; environmentally sealed and dual port connector packages including mixed density
- Broad selection of accessories
- Size 20 and 22 contacts suitable for use in carrying power
- IP65, IP67

Contact Sizes: 8, 16, 20 and 22
Current Ratings: To 100 amperes

Terminations: Crimp, wire solder, straight solder, right angle (90°) solder, straight compliant press-in and right angle (90°) compliant press-in

Configurations: Multiple variants in both standard and high densities, seven shell sizes

Qualifications: MIL-DTL-24308, GSFC S-311-P-4, GSFC S-311-P-10, SAE AS39029, DESC

RECTANGULAR



FEATURES:

- Two performance levels available: industrial quality and military quality
- A wide variety of accessories
- Broad selection of contact variants and package sizes
- Connector keying options

Contact Sizes: 16, 20 and 22
Current Ratings: To 13 amperes nominal

Terminations: Crimp, wire solder, straight solder, right angle (90°) solder, and straight compliant press-in

Configurations: Multiple variants in both standard and high densities, thirty package sizes

Qualifications: MIL-DTL-28748, SAE AS39029, CCITT V.35

CIRCULAR



FEATURES:

- Non-corrodible / lightweight composite construction
- EMI/RFI shielded versions
- Thermocouple contacts
- Environmentally sealed versions
- Rear insertion/ front release of removable contacts
- Two level sequential mating
- Overmolding available on full assemblies

Contact Sizes: 12, 16, 20 and 22
Current Ratings: To 25 amperes nominal

Terminations: Crimp, wire solder, straight solder, and right angle (90°) solder

Configurations: Multiple variants in four package sizes

Qualifications: Environmental protection to IP67

CABLE



FEATURES:

- Shorten the supply chain and reduce additional costs and delays by "cabling" your Positronic connector selection
- Overmolding available
- Shielded and environmentally sealed versions available
- Power cables and access boxes which meet the SAE J2496 specification

- ✓ Design assemblies in accordance with customer specifications.
- ✓ Prepare cabled connector configuration and performance specifications.
- ✓ Design each system in accordance with applicable customer, domestic, and international standards.
- ✓ Define and conduct performance and verification testing.

HERMETIC



FEATURES:

- Intended for use as an electrical feedthrough in high vacuum applications
- Leakage rate: 5 x 10⁻⁹ mbar.l/s @ vacuum 1.5 x 10⁻⁵ atm
- Signal, power, coax and high voltage versions available
- Connectors can be mounted on flange assembly per customer specification

Contact Sizes: 8, 12, 16, 20 and 22
Current Ratings: To 40 amperes nominal

Terminations: Feedthrough is standard; flying leads and board mount available upon request

Configurations: See D-subminiature and circular configurations above

Compliance: Space-D32

For more information, visit www.connectpositronic.com or call your nearest Positronic sales office listed on the back of this catalog.



Positronic[®]

an Amphenol company

Regional Headquarters

Positronic | Americas

423 N Campbell Ave
Springfield MO 65806 USA

+1 800 641 4054
info@connectpositronic.com

Positronic | Europe

Z.I. d'Engachies
46, route d'Engachies
F-32020 Auch Cedex 9 France

+33 5 6263 4491
contact@connectpositronic.com

Positronic | Asia

3014A Ubi RD 1 #07-01
Singapore 408703

+65 6842 1419
singapore@connectpositronic.com

Sales Offices

Positronic has local sales representation all over the world. To find the nearest sales office, please visit www.connectpositronic.com/locations

LOCATIONS

www.connectpositronic.com