



Overview

KEMET's PHA225 is a conductive polymer hybrid capacitor with outstanding electrical performance. The device has a polarized all-welded design, tinned copper wire leads, and a negative pole connected to the case. The PHA225 winding is housed in a cylindrical aluminum can with a high purity aluminum lid and high-quality rubber gasket. Low ESR is conditioned by a highly conductive polymer (PEDOT/PSS) and an all-welded design. The polymer system creates an electrical pathway between the anodic oxide layer and the cathode through a mechanical separator - paper. The PHA225 winding is impregnated with liquid electrolyte that results to self-healing features of the capacitor. Thanks to its mechanical robustness, the PHA225 is suitable for use in mobile, automotive and aircraft installations with operation up to +125°C.

Applications

KEMET's PHA225 is a series of high performance axial hybrid capacitors. It is designed for automotive applications with extremely high demands.

Benefits

- More than 3,000 hours at +125°C
- High temperature capability up to 140°C
- Extremely high ripple current
- Up to 40 A_{rms} continuous load
- High vibration resistance up to 30 g 22 h/axis
- Polarized all-welded design
- Self-healing behaviours
- Outstanding electrical performance



Part Number System

PHA225	M	KP	337	R	Q	E4
Series Rated	Voltage (VDC)	Size Code	Capacitance Code (µF)	Version	Capacitance Tolerance	Packaging
Hybrid Radial Crown Capacitor	K = 40 M = 63	See Dimension Table	The last two digits represent significant figures. The first digit indicates the total number digits	0 = Standard	Q = -10 +30% M = ±20%	E4 = Tray

Performance Characteristics

Item	Performance Characteristics	
Capacitance Range	370 – 1,100 μ F	
Rated Voltage	40 – 63 VDC	
Operating Temperature	-40 to +125°C	
Capacitance Tolerance	-10/+30%, (\pm 20% select values) at 100 Hz/+20°C	
Surge Voltage	1.15 x V _R	
High Temperature Storage	After storage for 1,000 hours at +125 °C with no voltage applied and then being stabilized at +20 °C, capacitors shall meet the limits specified in Endurance.	
Leakage Current	I = 0.005 CV (μ A)	
	C = rated capacitance (μ F), V = rated voltage (VDC). Voltage applied for 5 minutes at +20°C.	
Vibration Test Specifications	Procedure	Requirements
	1.5 mm displacement amplitude or 30 g maximum acceleration. Vibration applied for three 22-hour sessions at 10 – 2,000 Hz (capacitor clamped by body).	No leakage of electrolyte or other visible damage. Deviations in capacitance from initial measurements must not exceed: Δ C/C < 5%
Standards	AEC-Q200; IEC 60384-4 long life grade 40/125/56	

Compensation Factor of Ripple Current (RC) vs. Frequency

Frequency	0.1 kHz	0.2 kHz	1 kHz	5 kHz	10 kHz	20 kHz	40 kHz	100 kHz
Coefficient	0.20	0.30	0.55	0.85	0.90	0.95	1	1

Test Method & Performance

Endurance Life Test	
Conditions	Performance
Temperature	+125°C
Test Duration	3,000 hours
Voltage	The sum of DC voltage must not exceed the rated voltage of the capacitor
Performance	The following specifications will be satisfied when the capacitor is tested at +20°C:
Capacitance Change	Within 15% of initial value (within 10% at 1,000 hour test)
Equivalent Series Resistance	\leq 3x specified limit* (\leq 1.5x at 1,000 hour test)
Leakage Current	Does not exceed leakage current limit

*ESR measured at 100 kHz +20°C

Ordering Options Table

Packaging Kind	Lead Length (mm)	Lead and Packaging Code
Standard Packaging Option		
Tray	40 ±2	E4

Dimensions – Millimeters

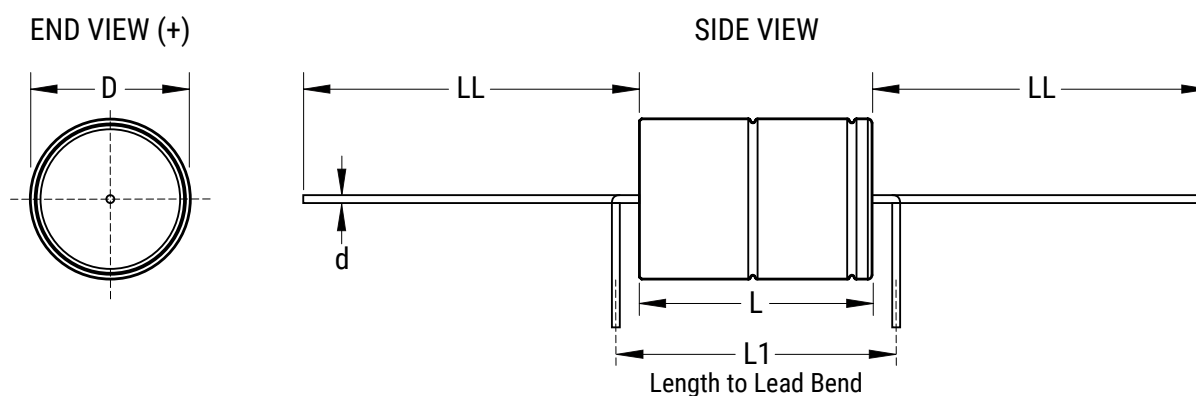

Size Code	Dimensions in mm					Approximate Weight Grams
	D	L	L1	d	LL	
	±0.5	±1	Minimum	±0.03	b±2 Box	
KP	16.2	34.7	41	1.0	40	11
LL	18.2	26.7	33	1.0	40	13
LP	18.2	34.7	41	1.0	40	20

Note: L1 is KEMET's recommendation for minimum distance between symmetrical Lead bend. Available only for Customer specific part numbers. Lead bend dimensions must be specified and confirmed per article.

Shelf Life

The capacitance, ESR and impedance of a capacitor will not change significantly after extended storage periods at temperatures up to 40°C, however the leakage current will very slowly increase.

Environmental Compliance



All Part Numbers in this datasheet are Reach and RoHS compliant and Halogen-Free.

As an environmentally conscious company, KEMET is working continuously with improvements concerning the environmental effects of both our capacitors and their production.

In Europe (RoHS Directive) and in some other geographical areas such as China, legislation has been put in place to prevent the use of some hazardous materials, such as lead (Pb), in electronic equipment. All products in this catalog are produced to help our customers' obligations to guarantee their products and fulfill these legislative requirements. The only material of concern in our products has been lead (Pb), which has been removed from all designs to fulfill the requirement of containing less than 0.1% of lead in any homogeneous material. KEMET will closely follow any changes in legislation world wide and makes any necessary changes in its products, whenever needed.

Some customer segments such as medical, military, and automotive electronics may still require the use of lead in electrode coatings. To clarify the situation and distinguish products from each other, a special symbol is used on the packaging labels for RoHS compatible capacitors.

Table 1 – Ratings & Part Number Reference

C_R	D x L	I_{RAC}^a $T_c = 70^\circ C$ 100 kHz	I_{RAC}^a $T_c = 90^\circ C$ 100 kHz	I_{RAC}^a $T_c = 105^\circ C$ 100 kHz	I_{RAC}^b $T_c = 125^\circ C$ 100 kHz	ESR (Maximum) 20°C 100 Hz	ESR (Maximum) -40 to 125°C 100 kHz	Part Number
μF	mm	A_{RMS}	A_{RMS}	A_{RMS}	A_{RMS}	mOhm	mOhm	
40 VDC (UR)								
1,100	18x35	40.9	33.4	27.0	15.5	80	6.0	PHA225KLP4110QE4
63 VDC (UR)								
370	16x35	39.5	33.1	26.5	16.2	145	6.1	PHA225MKP3370QE4
380	18x27	36.8	31.0	25.3	15.3	147	7.1	PHA225MLL3380QE4
560	18x35	40.9	33.4	27.0	15.5	92	6.0	PHA225MLP3560QE4

a 3,000 hours

b 2,000 hours

Operational Life

Operational life (L_{op}) at case temperature T_c and ripple current I_{AC} .
Diagram is valid for both diameter 16 mm and 18 mm case sizes.

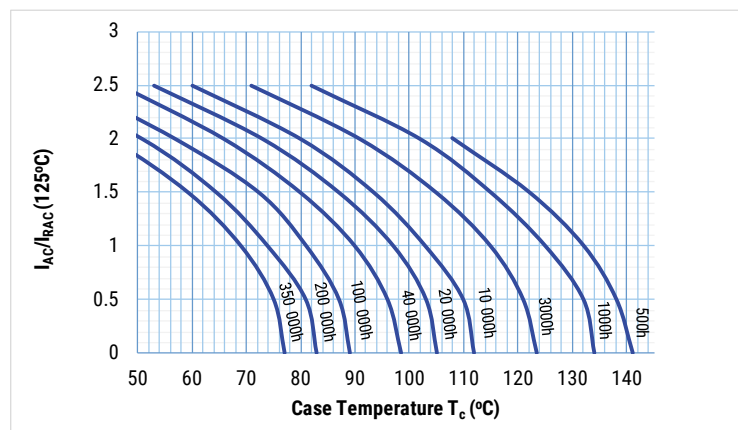

Example:

Article: PHA225MKP3370QE4 (16 x 35 mm)

Case temperature (T_c): +120°C

Ripple current at 100 kHz (I_{AC}): 20.3 A

I_{RAC} (+125°C, 100 kHz) = 16.2 A (from data table) » I_{AC}/I_{RAC} (+125°C) = 1.25 Operational life: interpolation between the L_{op} -curves » $L_{op} \sim 1,000$ hours (blue curves)

Mechanical Data

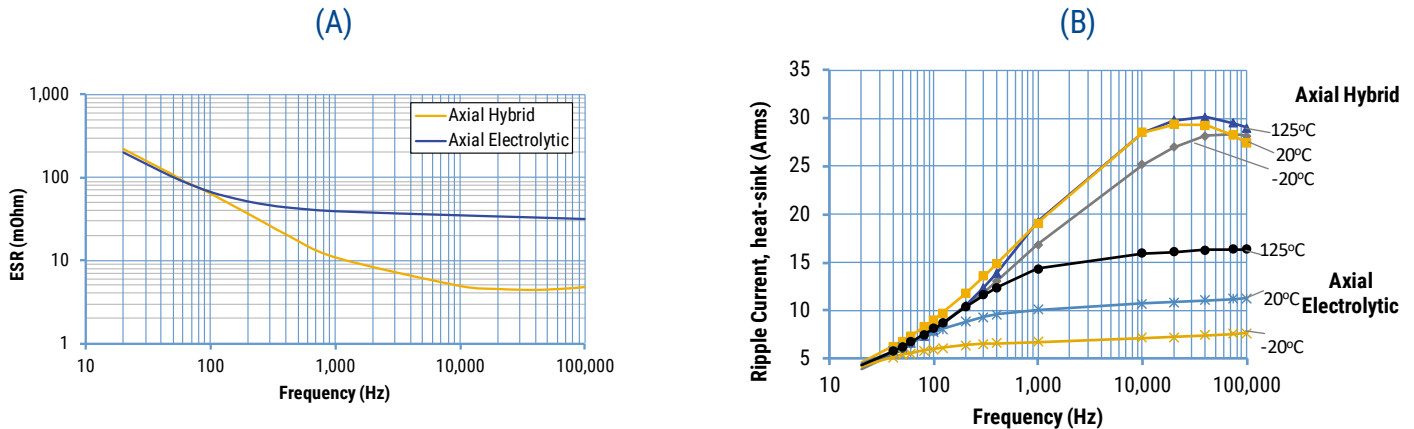

Frequency dependencies of ESR measured at 20°C and 100 kHz for Axial Hybrid (PHA225MKP3370QE4) and Axial Electrolytic (PEG226MG3370QE1) capacitors (A); Frequency dependencies of max. short pulse Ripple Current at different temperatures for heat-sink mounted Axial Hybrid (PHA225MKP3370QE4) and Axial Electrolytic (PEG226MG3370QE1) capacitors (B).

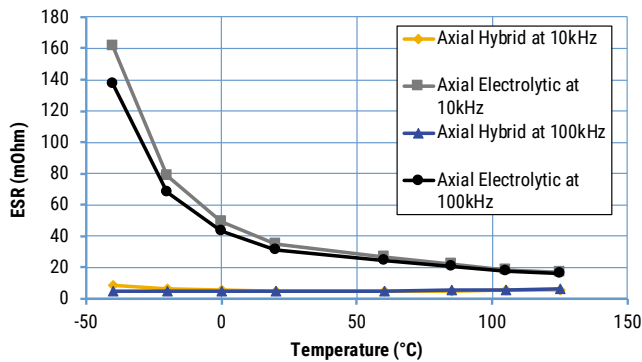

Temperature dependencies of ESR measured at 10 kHz and 100 kHz for Axial Hybrid (PHA225MKP3370QE4) and Axial Electrolytic (PEG226MG3370QE1) capacitors.

Marking

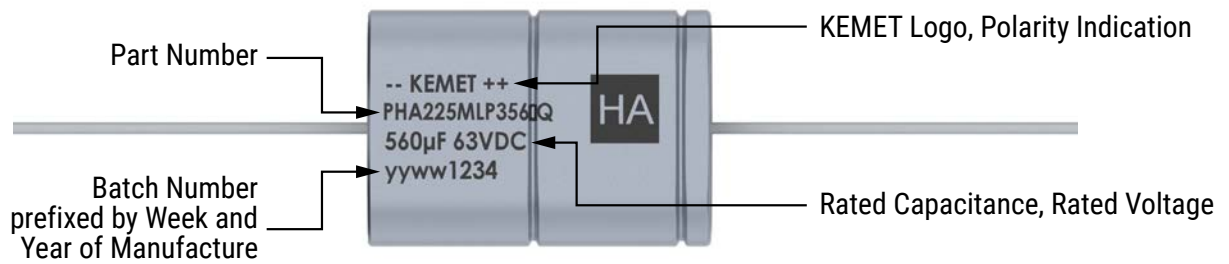

Construction

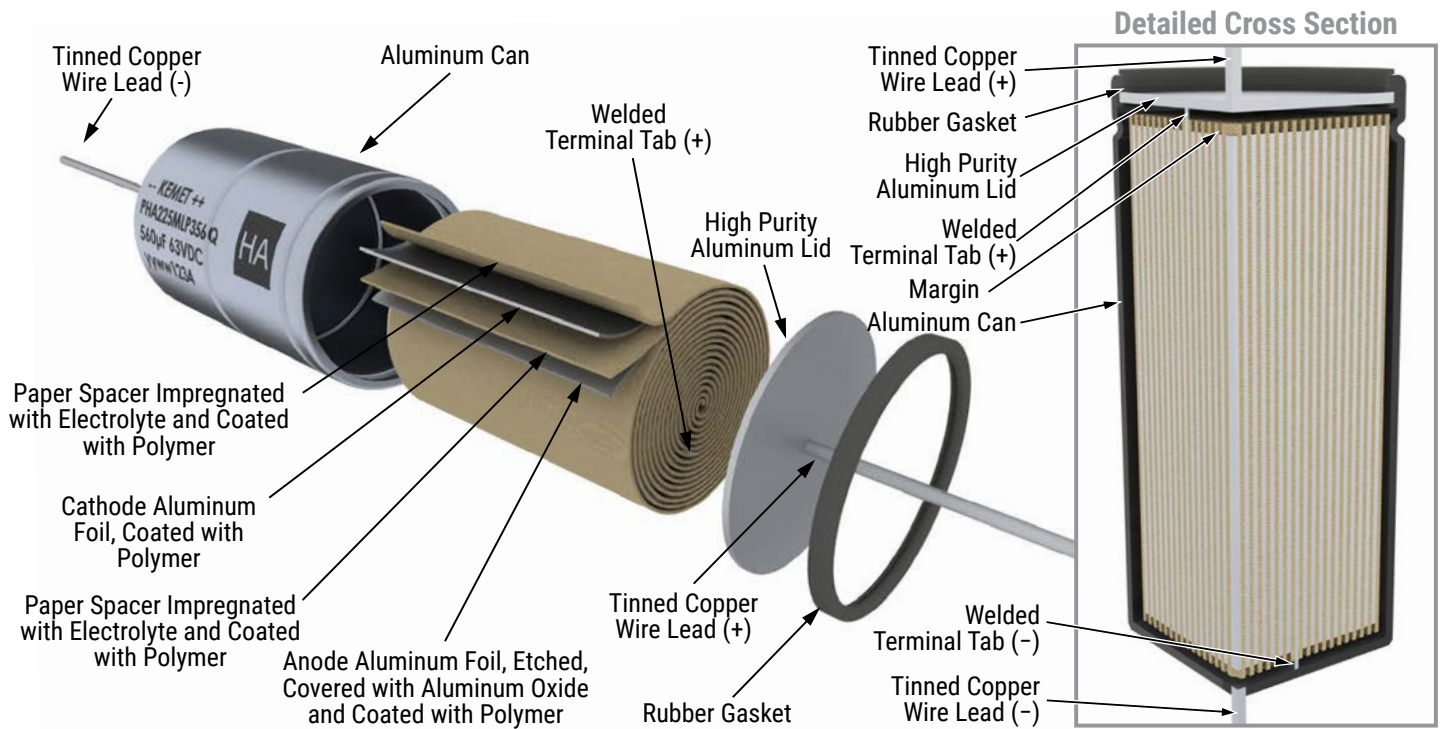

Construction Data

The manufacturing process begins with the anode foil being electrochemically etched to increase the surface area and then “formed” to produce the aluminum oxide layer. Both the anode and cathode foils are then interleaved with absorbent paper and wound into a cylinder. During the winding process, aluminum tabs are attached to each foil to provide the electrical contact.

The winding is assembled to the capacitor Al-can and to the Al-lid. The can is filled with electrolyte and the winding is impregnated during a vacuum treatment. The capacitor is sealed. Throughout the process, all materials inside the housing must be maintained at the highest purity and be compatible with the electrolyte.

Each capacitor is aged and tested before being packed. The purpose of aging is to repair any damage in the oxide layer and thus reduce the leakage current to a very low level. Aging is carried out at elevated temperature and is accomplished by applying voltage to the device while carefully controlling the supply current. The process takes between 2 and 20 hours, depending on voltage rating.

Damage to the oxide layer can occur due to a variety of reasons:

- Slitting of the anode foil after forming
- Attaching the tabs to the anode foil
- Minor mechanical damage caused during winding

The following tests are applied for each individual capacitor.

Electrical:

- Leakage current
- Capacitance
- ESR
- Tan Delta

Mechanical/Visual:

- Pull strength test of wire terminals
- Print detail
- Box labels
- Packaging, including packed quantity

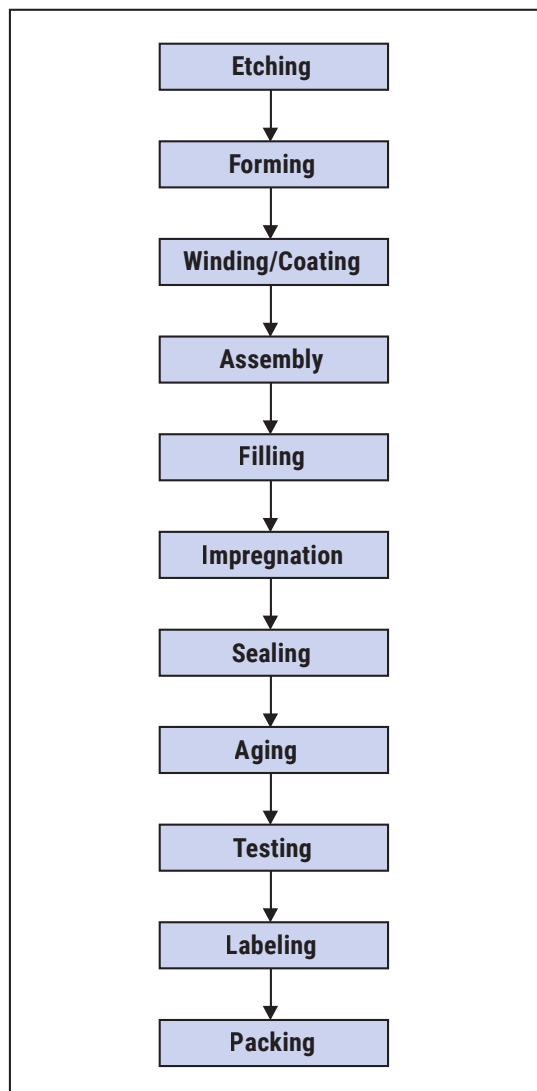

KEMET Electronics Corporation Sales Offices

For a complete list of our global sales offices, please visit www.kemet.com/sales.

Disclaimer

All product specifications, statements, information and data (collectively, the "Information") in this datasheet are subject to change. The customer is responsible for checking and verifying the extent to which the Information contained in this publication is applicable to an order at the time the order is placed. All Information given herein is believed to be accurate and reliable, but it is presented without guarantee, warranty, or responsibility of any kind, expressed or implied.

Statements of suitability for certain applications are based on KEMET Electronics Corporation's ("KEMET") knowledge of typical operating conditions for such applications, but are not intended to constitute – and KEMET specifically disclaims – any warranty concerning suitability for a specific customer application or use. The Information is intended for use only by customers who have the requisite experience and capability to determine the correct products for their application. Any technical advice inferred from this Information or otherwise provided by KEMET with reference to the use of KEMET's products is given gratis, and KEMET assumes no obligation or liability for the advice given or results obtained.

Although KEMET designs and manufactures its products to the most stringent quality and safety standards, given the current state of the art, isolated component failures may still occur. Accordingly, customer applications which require a high degree of reliability or safety should employ suitable designs or other safeguards (such as installation of protective circuitry or redundancies) in order to ensure that the failure of an electrical component does not result in a risk of personal injury or property damage.

Although all product-related warnings, cautions and notes must be observed, the customer should not assume that all safety measures are indicated or that other measures may not be required.

KEMET is a registered trademark of KEMET Electronics Corporation.