

CSHDD16-40C CSHDD16-100C
 CSHDD16-60C CSHDD16-200C

**SURFACE MOUNT SILICON
 DUAL, COMMON CATHODE
 SCHOTTKY RECTIFIERS
 16 AMP, 40 THRU 200 VOLT**



www.centrasemi.com

DESCRIPTION:

The CENTRAL SEMICONDUCTOR CSHDD16-40C series devices are silicon Schottky rectifiers designed for surface mount applications requiring a low forward voltage drop.

MARKING:

CSHDD16-40C: CSHDD16-40C or CSHDD16-40
CSHDD16-60C: CSHDD16-60C or CSHDD16-60
CSHDD16-100C: CSHDD16-100C or CSHDD16-100
CSHDD16-200C: CSHDD16-200C or CSHDD16-200



FEATURES:

- High reliability
- Low forward voltage
- High current capability
- High surge capacity
- UL flammability classification 94V-O
- Superior lot to lot consistency
- Low power loss, high efficiency
- High voltage

MAXIMUM RATINGS: ($T_A=25^{\circ}\text{C}$ unless otherwise noted)

	SYMBOL	CSHDD16				UNITS
		-40C	-60C	-100C	-200C	
Peak Repetitive Reverse Voltage	V_{RRM}	40	60	100	200	V
DC Blocking Voltage	V_R	40	60	100	200	V
RMS Reverse Voltage	$V_{R(RMS)}$	28	42	70	140	V
Average Forward Current ($T_L=75^{\circ}\text{C}$)	I_O		16			A
Peak Forward Surge Current, $t_p=8.3\text{ms}$	I_{FSM}		150			A
Operating and Storage Junction Temperature	T_J, T_{stg}		-65 to +175			$^{\circ}\text{C}$
Typical Thermal Resistance	θ_{JL}		2.0			$^{\circ}\text{C/W}$
Typical Thermal Resistance	θ_{JA}		50			$^{\circ}\text{C/W}$

ELECTRICAL CHARACTERISTICS PER DIODE: ($T_A=25^{\circ}\text{C}$ unless otherwise noted)

SYMBOL	TEST CONDITIONS	CSHDD16								UNITS
		-40C		-60C		-100C		-200C		
		TYP	MAX	TYP	MAX	TYP	MAX	TYP	MAX	
I_R	$V_R=\text{Rated } V_{RRM}$	-	50	-	50	-	50	-	50	μA
I_R	$V_R=\text{Rated } V_{RRM}, T_J=100^{\circ}\text{C}$	-	20	-	20	-	20	-	20	mA
V_F	$I_F=8.0\text{A}$	0.49	0.7	0.58	0.75	0.75	0.8	0.83	0.9	V
V_F	$I_F=16\text{A}$	0.6	0.84	0.75	0.95	0.83	1.10	0.91	1.2	V
C_J	$V_R=4.0\text{V}, f=1.0\text{MHz}$	379	-	280	-	353	-	166	-	pF

CSHDD16-40C CSHDD16-100C
 CSHDD16-60C CSHDD16-200C



**SURFACE MOUNT SILICON
 DUAL, COMMON CATHODE
 SCHOTTKY RECTIFIERS
 16 AMP, 40 THRU 200 VOLT**

D²PAK CASE - MECHANICAL OUTLINE

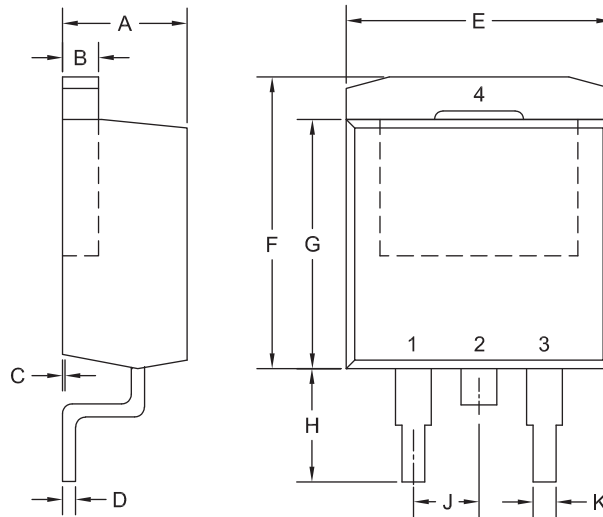

R3

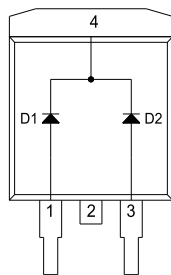

LEAD CODE:
 1) Anode D1
 2) Cathode D1, D2
 3) Anode D2
 4) Cathode D1, D2
 Pin 2 is Common to the Ta

SYMBOL	DIMENSIONS			
	INCHES		MILLIMETERS	
	MIN	MAX	MIN	MAX
A	0.163	0.189	4.14	4.80
B	0.045	0.055	1.14	1.40
C	0.000	0.010	0.00	0.25
D	0.012	0.028	0.30	0.70
E	0.386	0.415	9.80	10.55
F	0.378	0.417	9.60	10.60
G	0.335	0.358	8.50	9.10
H	0.188	0.236	4.78	6.00
J	0.093	0.108	2.35	2.75
K	0.030	0.035	0.75	0.90

D2PAK (REV: R3)

R9 (11-January 2018)

CSHDD16-40C CSHDD16-100C
 CSHDD16-60C CSHDD16-200C



SURFACE MOUNT SILICON
 DUAL, COMMON CATHODE
 SCHOTTKY RECTIFIERS
 16 AMP, 40 THRU 200 VOLT

TYPICAL ELECTRICAL CHARACTERISTICS

Leakage Current for CSHDD16-40C

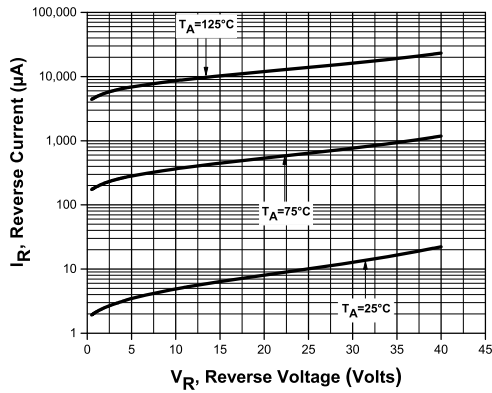

Leakage Current for CSHDD16-60C

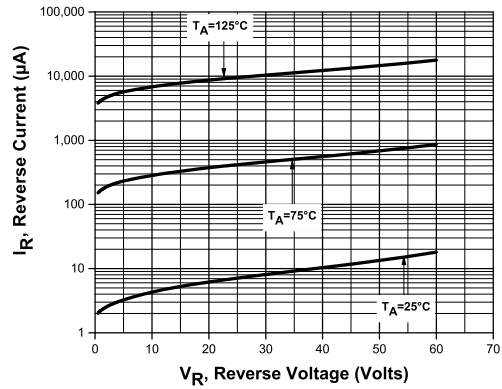

Leakage Current for CSHDD16-100C

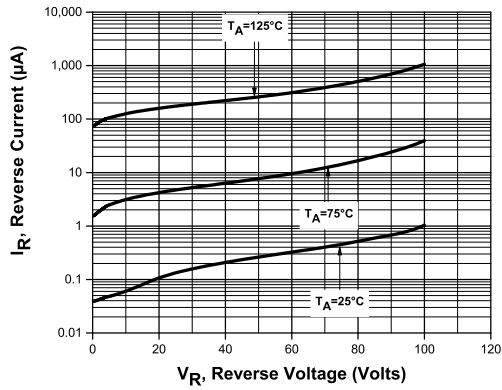

Leakage Current for CSHDD16-200C

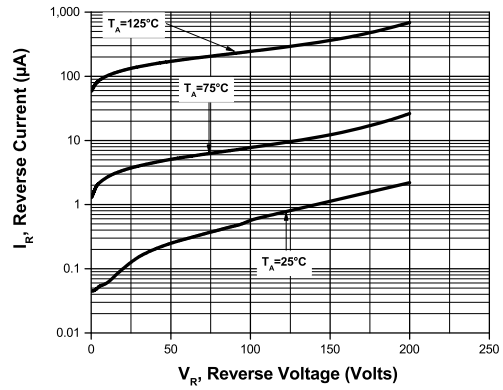

R9 (11-January 2018)

CSHDD16-40C CSHDD16-100C
 CSHDD16-60C CSHDD16-200C



SURFACE MOUNT SILICON
 DUAL, COMMON CATHODE
 SCHOTTKY RECTIFIERS
 16 AMP, 40 THRU 200 VOLT

TYPICAL ELECTRICAL CHARACTERISTICS

Forward Voltage for CSHDD16-40C per diode

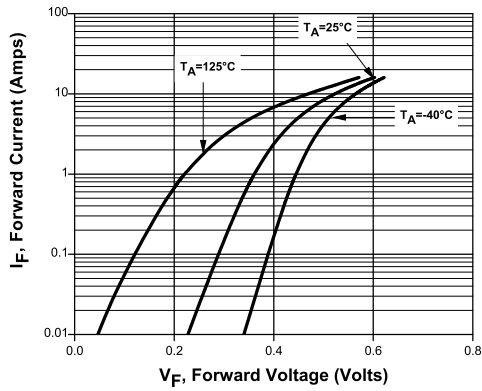

Forward Voltage for CSHDD16-40C, two diodes in parallel

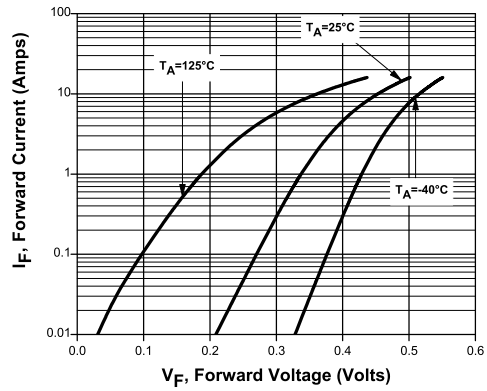

Forward Voltage for CSHDD16-60C per diode

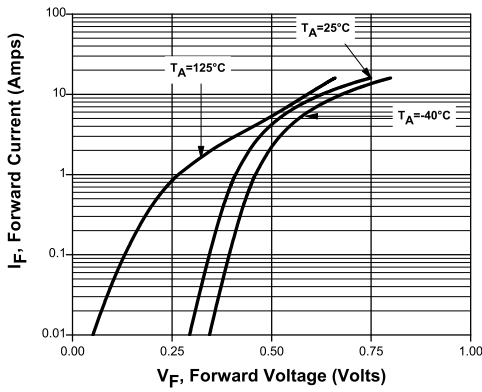

Forward Voltage for CSHDD16-60C, two diodes in parallel

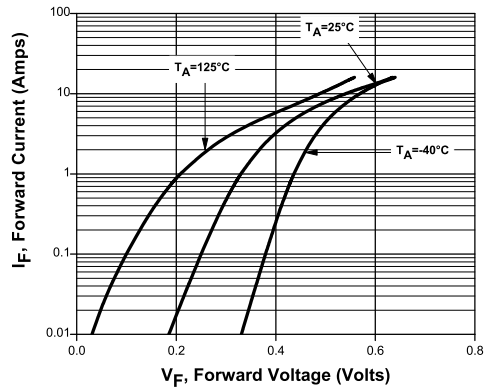

R9 (11-January 2018)

CSHDD16-40C CSHDD16-100C
 CSHDD16-60C CSHDD16-200C



SURFACE MOUNT SILICON
 DUAL, COMMON CATHODE
 SCHOTTKY RECTIFIERS
 16 AMP, 40 THRU 200 VOLT

TYPICAL ELECTRICAL CHARACTERISTICS

Forward Voltage for CSHDD16-100C per diode

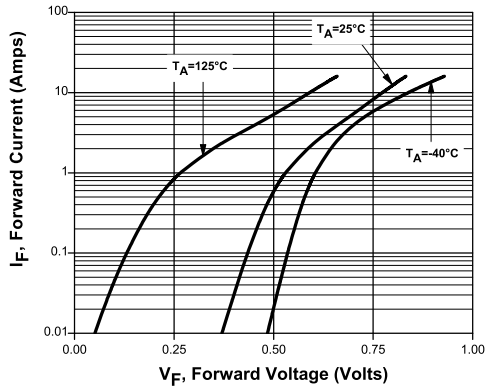

Forward Voltage for CSHDD16-100C, two diodes in parallel

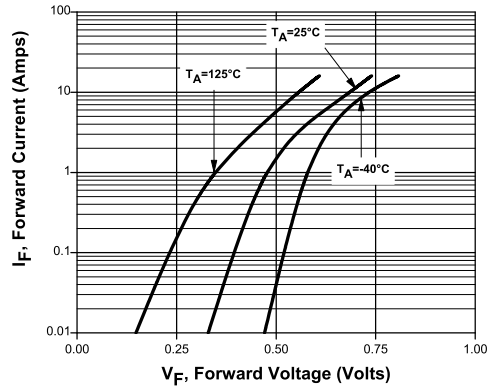

Forward Voltage for CSHDD16-200C per diode

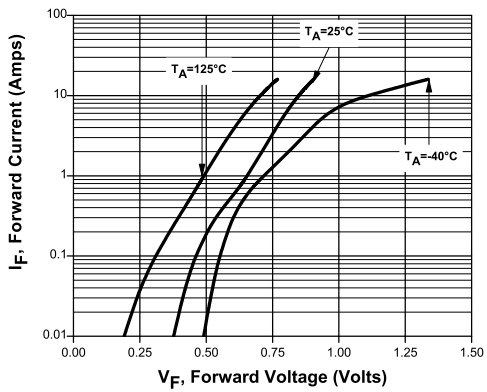

Forward Voltage for CSHDD16-200C, two diodes in parallel

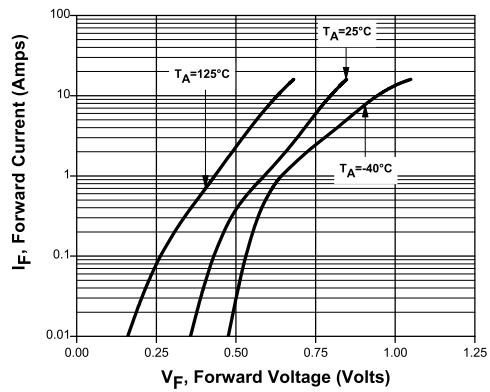

R9 (11-January 2018)

CSHDD16-40C CSHDD16-100C
 CSHDD16-60C CSHDD16-200C



SURFACE MOUNT SILICON
 DUAL, COMMON CATHODE
 SCHOTTKY RECTIFIERS
 16 AMP, 40 THRU 200 VOLT

TYPICAL ELECTRICAL CHARACTERISTICS

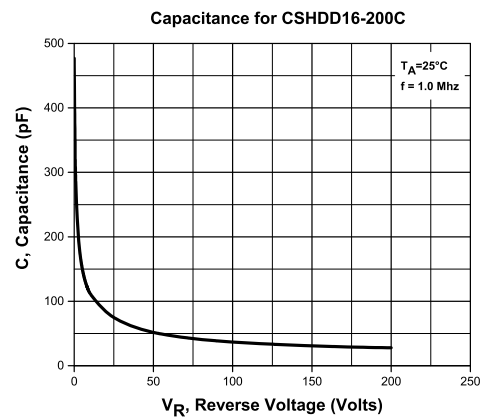
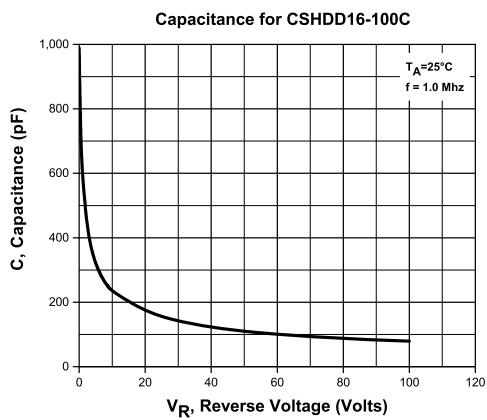
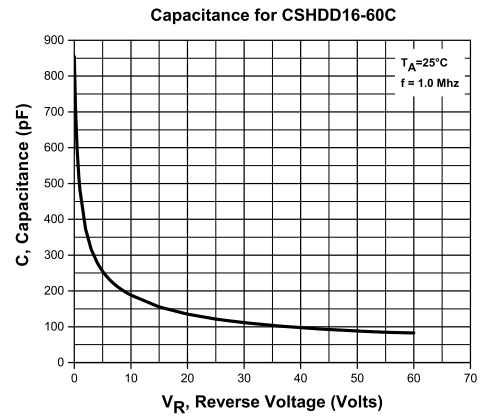
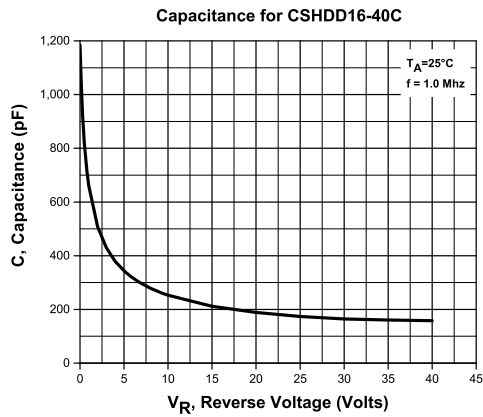

R9 (11-January 2018)

CSHDD16-40C CSHDD16-100C
CSHDD16-60C CSHDD16-200C

SURFACE MOUNT SILICON
DUAL, COMMON CATHODE
SCHOTTKY RECTIFIERS
16 AMP, 40 THRU 200 VOLT



TYPICAL ELECTRICAL CHARACTERISTICS

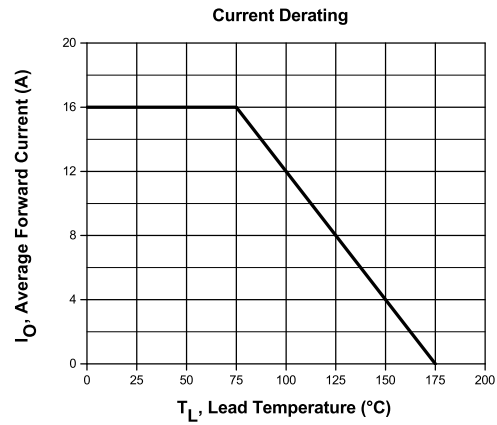

R9 (11-January 2018)

OUTSTANDING SUPPORT AND SUPERIOR SERVICES



PRODUCT SUPPORT

Central's operations team provides the highest level of support to insure product is delivered on-time.

- Supply management (Customer portals)
- Inventory bonding
- Consolidated shipping options
- Custom bar coding for shipments
- Custom product packing

DESIGNER SUPPORT/SERVICES

Central's applications engineering team is ready to discuss your design challenges. Just ask.

- Free quick ship samples (2nd day air)
- Online technical data and parametric search
- SPICE models
- Custom electrical curves
- Environmental regulation compliance
- Customer specific screening
- Up-screening capabilities
- Special wafer diffusions
- PbSn plating options
- Package details
- Application notes
- Application and design sample kits
- Custom product and package development

REQUESTING PRODUCT PLATING

1. If requesting Tin/Lead plated devices, add the suffix "TIN/LEAD" to the part number when ordering (example: 2N2222A TIN/LEAD).
2. If requesting Lead (Pb) Free plated devices, add the suffix "PBFREE" to the part number when ordering (example: 2N2222A PBFREE).

CONTACT US

Corporate Headquarters & Customer Support Team

Central Semiconductor Corp.
145 Adams Avenue
Hauppauge, NY 11788 USA
Main Tel: (631) 435-1110
Main Fax: (631) 435-1824
Support Team Fax: (631) 435-3388
www.centrasemi.com

Worldwide Field Representatives:
www.centrasemi.com/wwreps

Worldwide Distributors:
www.centrasemi.com/wwdistributors

For the latest version of Central Semiconductor's **LIMITATIONS AND DAMAGES DISCLAIMER**, which is part of Central's Standard Terms and Conditions of sale, visit: www.centrasemi.com/terms