

TLE2027, TLE2027A, TLE2027Y EXCALIBUR LOW-NOISE HIGH-SPEED PRECISION OPERATIONAL AMPLIFIERS

SLOS054D - MAY 1990 - REVISED SEPTEMBER 1996

- Outstanding Combination of dc Precision and AC Performance:
 - Unity-Gain Bandwidth . . . 15 MHz Typ
 - V_n 3.3 nV/ $\sqrt{\text{Hz}}$ at $f = 10$ Hz Typ,
2.5 nV/ $\sqrt{\text{Hz}}$ at $f = 1$ kHz Typ
 - V_{IO} 25 μV Max
 - A_{VD} . . . 45 V/ μV Typ With $R_L = 2$ k Ω ,
19 V/ μV Typ With $R_L = 600$ Ω

- Available in Standard-Pinout Small-Outline Package
- Output Features Saturation Recovery Circuitry
- Macromodels and Statistical information

description

The TLE2027 and TLE2027A contain innovative circuit design expertise and high-quality process control techniques to produce a level of ac performance and dc precision previously unavailable in single operational amplifiers. Manufactured using Texas Instruments state-of-the-art Excalibur process, these devices allow upgrades to systems that use lower-precision devices.

In the area of dc precision, the TLE2027 and TLE2027A offer maximum offset voltages of 100 μV and 25 μV , respectively, common-mode rejection ratio of 131 dB (typ), supply voltage rejection ratio of 144 dB (typ), and dc gain of 45 V/ μV (typ).

The ac performance is highlighted by a typical unity-gain bandwidth specification of 15 MHz, 55° of phase margin, and noise voltage specifications of 3.3 nV/ $\sqrt{\text{Hz}}$ and 2.5 nV/ $\sqrt{\text{Hz}}$ at frequencies of 10 Hz and 1 kHz respectively.

LARGE-SIGNAL
DIFFERENTIAL VOLTAGE AMPLIFICATION
vs
FREQUENCY

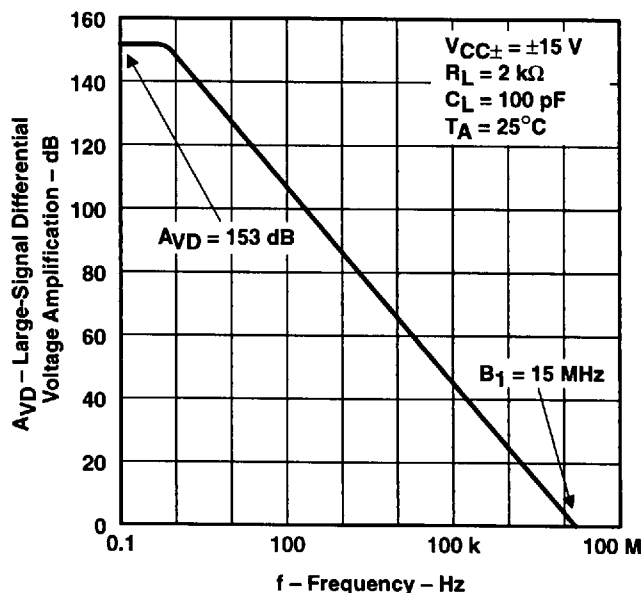

AVAILABLE OPTIONS

T_A	V_{IOmax} AT 25°C	PACKAGED DEVICES				CHIP FORM (Y)
		SMALL OUTLINE (D)	CHIP CARRIER (FK)	CERAMIC DIP (JG)	PLASTIC DIP (P)	
0°C to 70°C	25 μV 100 μV	TLE2027ACD TLE2027CD	— —	— —	TLE2027ACP TLE2027CP	— TLE2027Y
-40°C to 105°C	25 μV 100 μV	TLE2027AID TLE2027ID	— —	— —	TLE2027AIP TLE2027IP	— —
-55°C to 125°C	25 μV 100 μV	TLE2027AMD TLE2027MD	TLE2027AMFK TLE2027MFK	TLE2027AMJG TLE2027MJG	TLE2027AMP TLE2027MP	— —

The D packages are available taped and reeled. Add R suffix to device type (e.g., TLE2027ACDR).



Please be aware that an important notice concerning availability, standard warranty, and use in critical applications of Texas Instruments semiconductor products and disclaimers thereto appears at the end of this data sheet.

PRODUCTION DATA information is current as of publication date. Products conform to specifications per the terms of Texas Instruments standard warranty. Production processing does not necessarily include testing of all parameters.



POST OFFICE BOX 655303 • DALLAS, TEXAS 75265

Copyright © 1996, Texas Instruments Incorporated
On products compliant to MIL-PRF-38535, all parameters are tested unless otherwise noted. On all other products, production processing does not necessarily include testing of all parameters.

TLE2027, TLE2027A, TLE2027Y EXCALIBUR LOW-NOISE HIGH-SPEED PRECISION OPERATIONAL AMPLIFIERS

SLOS054D – MAY 1990 – REVISED SEPTEMBER 1996

description (continued)

Both the TLE2027 and TLE2027A are available in a wide variety of packages, including the industry-standard 8-pin small-outline version for high-density system applications. The C-suffix devices are characterized for operation from 0°C to 70°C. The I-suffix devices are characterized for operation from -40°C to 105°C. The M-suffix devices are characterized for operation over the full military temperature range of -55°C to 125°C.

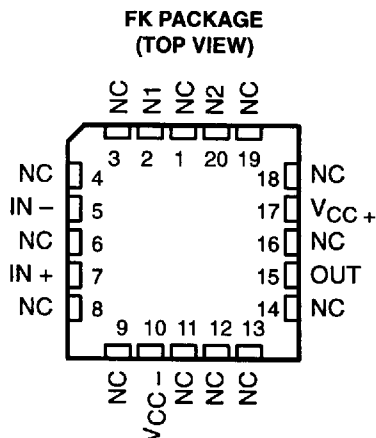
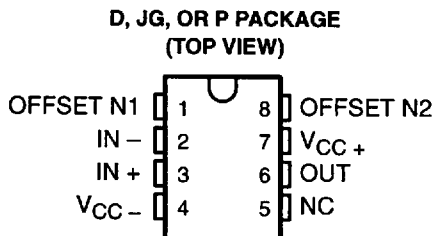

NC – No internal connection

symbol

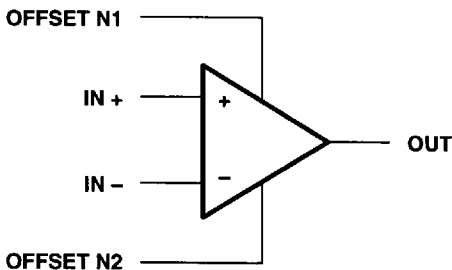

TLE2027, TLE2027A, TLE2027Y EXCALIBUR LOW-NOISE HIGH-SPEED PRECISION OPERATIONAL AMPLIFIERS

SLOS054D – MAY 1990 – REVISED SEPTEMBER 1996

TLE2027Y chip information

This chip, when properly assembled, displays characteristics similar to the TLE2027C. Thermal compression or ultrasonic bonding may be used on the doped-aluminum bonding pads. The chip may be mounted with conductive epoxy or a gold-silicon preform.

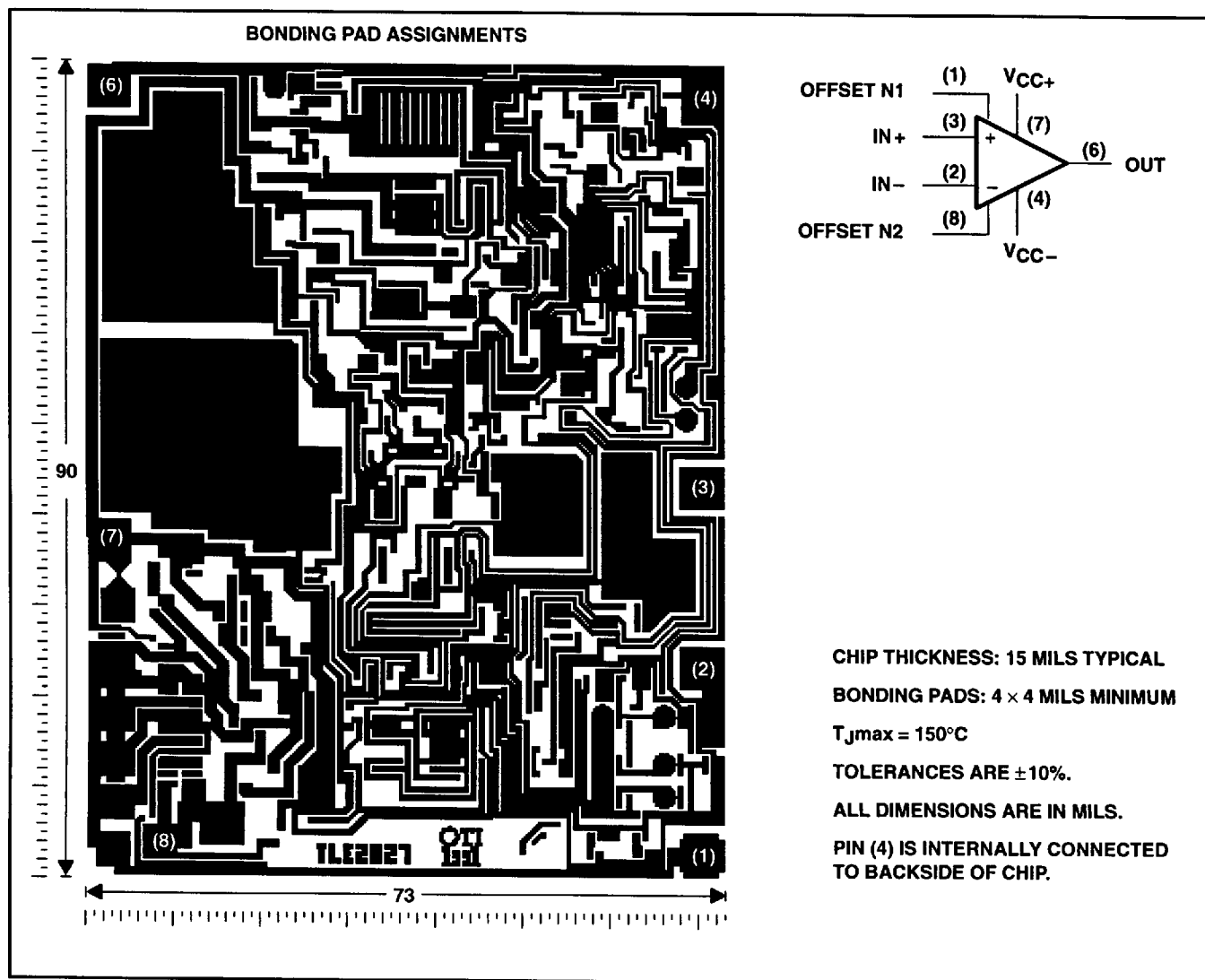

POST OFFICE BOX 655303 • DALLAS, TEXAS 75265

8961724 0103599 220

TLE2027, TLE2027A, TLE2027Y
EXCALIBUR LOW-NOISE HIGH-SPEED
PRECISION OPERATIONAL AMPLIFIERS
 SLOS054D - MAY 1990 - REVISED SEPTEMBER 1996

equivalent schematic

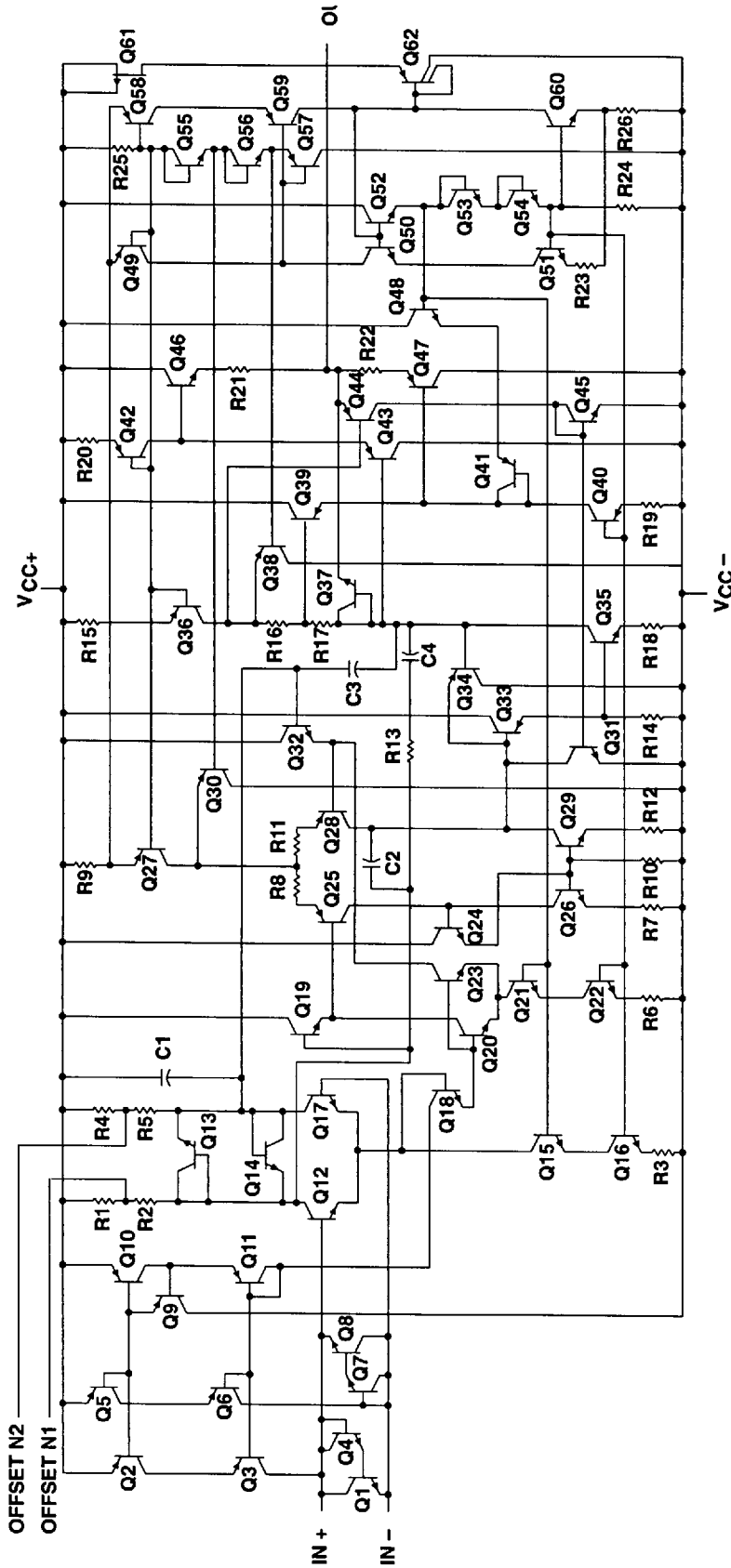

COMPONENT COUNT	
Transistors	61
Resistors	26
Capacitors	4
epi/FET	1



TLE2027, TLE2027A, TLE2027Y
EXCALIBUR LOW-NOISE HIGH-SPEED
PRECISION OPERATIONAL AMPLIFIERS

SLOS054D - MAY 1990 - REVISED SEPTEMBER 1996

absolute maximum ratings over operating free-air temperature range (unless otherwise noted)†

Supply voltage, V_{CC+} (see Note 1)	19 V
Supply voltage, V_{CC-}	-19 V
Differential input voltage, V_{ID} (see Note 2)	± 1.2 V
Input voltage range, V_I (any input)	$V_{CC\pm}$
Input current, I_I (each input)	± 1 mA
Output current, I_O	± 50 mA
Total current into V_{CC+}	50 mA
Total current out of V_{CC-}	50 mA
Duration of short-circuit current at (or below) 25°C (see Note 3)	unlimited
Continuous total power dissipation	See Dissipation Rating Table
Operating free-air temperature range, T_A : C suffix	0°C to 70°C
I suffix	-40°C to 105°C
M suffix	-55°C to 125°C
Storage temperature range, T_{stg}	-65°C to 150°C
Case temperature for 60 seconds, T_C : FK package	260°C
Lead temperature 1,6 mm (1/16 inch) from case for 10 seconds: D or P package	260°C
Lead temperature 1,6 mm (1/16 inch) from case for 60 seconds: JG package	300°C

† Stresses beyond those listed under "absolute maximum ratings" may cause permanent damage to the device. These are stress ratings only, and functional operation of the device at these or any other conditions beyond those indicated under "recommended operating conditions" is not implied. Exposure to absolute-maximum-rated conditions for extended periods may affect device reliability.

- NOTES:
- All voltage values, except differential voltages, are with respect to the midpoint between V_{CC+} and V_{CC-} .
 - Differential voltages are at $IN+$ with respect to $IN-$. Excessive current flows if a differential input voltage in excess of approximately ± 1.2 V is applied between the inputs unless some limiting resistance is used.
 - The output may be shorted to either supply. Temperature and/or supply voltages must be limited to ensure that the maximum dissipation rating is not exceeded.

DISSIPATION RATING TABLE

PACKAGE	$T_A \leq 25^\circ\text{C}$	DERATING FACTOR ABOVE $T_A = 25^\circ\text{C}$	$T_A = 70^\circ\text{C}$	$T_A = 105^\circ\text{C}$	$T_A = 125^\circ\text{C}$
	POWER RATING		POWER RATING	POWER RATING	POWER RATING
D	725 mW	5.8 mW/°C	464 mW	261 mW	145 mW
FK	1375 mW	11.0 mW/°C	880 mW	495 mW	275 mW
JG	1050 mW	8.4 mW/°C	672 mW	378 mW	210 mW
P	1000 mW	8.0 mW/°C	640 mW	360 mW	200 mW

recommended operating conditions

		C SUFFIX		I SUFFIX		M SUFFIX		UNIT
		MIN	MAX	MIN	MAX	MIN	MAX	
Supply voltage, $V_{CC\pm}$		± 4	± 19	± 4	± 19	± 4	± 19	V
Common-mode input voltage, V_{IC}	$T_A = 25^\circ\text{C}$	-11	11	-11	11	-11	11	V
	$T_A = \text{Full range}^\ddagger$	-10.5	10.5	-10.4	10.4	-10.2	10.2	
Operating free-air temperature, T_A		0	70	-40	105	-55	125	°C

‡ Full range is 0°C to 70°C for C-suffix devices, -40°C to 105°C for I-suffix devices, and -55°C to 125°C for M-suffix devices.



POST OFFICE BOX 655303 • DALLAS, TEXAS 75265

TLE2027, TLE2027A, TLE2027Y
EXCALIBUR LOW-NOISE HIGH-SPEED
PRECISION OPERATIONAL AMPLIFIERS

SLOS054D – MAY 1990 – REVISED SEPTEMBER 1996

electrical characteristics at specified free-air temperature, $V_{CC\pm} = \pm 15\text{ V}$ (unless otherwise noted)

PARAMETER	TEST CONDITIONS	T_A †	TLE2027C			TLE2027AC			UNIT
			MIN	TYP	MAX	MIN	TYP	MAX	
V_{IO} Input offset voltage		25°C		20	100		10	25	μV
		Full range			145			70	
α_{VIO} Temperature coefficient of input offset voltage	$V_{IC} = 0, R_S = 50\ \Omega$	Full range		0.4	1		0.2	1	$\mu\text{V}/^\circ\text{C}$
Input offset voltage long-term drift (see Note 4)		25°C		0.006	1		0.006	1	$\mu\text{V}/\text{mo}$
I_{IO} Input offset current		25°C		6	90		6	90	nA
	Full range			150			150		
I_{IB} Input bias current		25°C		15	90		15	90	nA
		Full range			150			150	
V_{ICR} Common-mode input voltage range	$R_S = 50\ \Omega$	25°C	-11 to 11	-13 to 13		-11 to 11	-13 to 13	V	
		Full range	-10.5 to 10.5			-10.5 to 10.5			
V_{OM+} Maximum positive peak output voltage swing	$R_L = 600\ \Omega$	25°C		10.5		10.5		V	
		Full range		10		10			
	$R_L = 2\ \text{k}\Omega$	25°C		12		12			
		Full range		11		11			
V_{OM-} Maximum negative peak output voltage swing	$R_L = 600\ \Omega$	25°C	-10.5	-13		-10.5	-13	V	
		Full range	-10			-10			
	$R_L = 2\ \text{k}\Omega$	25°C	-12	-13.5		-12	-13.5		
		Full range	-11			-11			
A_{VD} Large-signal differential voltage amplification	$V_O = \pm 11\ \text{V}, R_L = 2\ \text{k}\Omega$	25°C	5	45		10	45	V/ μV	
		Full range	2			4			
	$V_O = \pm 10\ \text{V}, R_L = 1\ \text{k}\Omega$	25°C	3.5	38		8	38		
		Full range	1			2.5			
	$V_O = \pm 10\ \text{V}, R_L = 600\ \Omega$	25°C	2	19		5	19		
		Full range	0.5			2			
C_i Input capacitance		25°C		8		8	pF		
z_o Open-loop output impedance	$I_O = 0$	25°C		50		50	Ω		
CMRR Common-mode rejection ratio	$V_{IC} = V_{ICRmin}, R_S = 50\ \Omega$	25°C	100	131		117	131	dB	
		Full range	98			114			
k_{SVR} Supply-voltage rejection ratio ($\Delta V_{CC\pm} / \Delta V_{IO}$)	$V_{CC\pm} = \pm 4\ \text{V to } \pm 18\ \text{V}, R_S = 50\ \Omega$	25°C	94	144		110	144	dB	
		Full range	92			106			
I_{CC} Supply current	$V_O = 0, \text{ No load}$	25°C		3.8	5.3		3.8	5.3	mA
		Full range			5.6			5.6	

† Full range is 0°C to 70°C.

NOTE 4: Typical values are based on the input offset voltage shift observed through 168 hours of operating life test at $T_A = 150^\circ\text{C}$ extrapolated to $T_A = 25^\circ\text{C}$ using the Arrhenius equation and assuming an activation energy of 0.96 eV.



TLE2027, TLE2027A, TLE2027Y
EXCALIBUR LOW-NOISE HIGH-SPEED
PRECISION OPERATIONAL AMPLIFIERS

SLOS054D – MAY 1990 – REVISED SEPTEMBER 1996

operating characteristics at specified free-air temperature, $V_{CC} \pm = \pm 15$ V

PARAMETER	TEST CONDITIONS	T_A †	TLE2027C			TLE2027AC			UNIT
			MIN	TYP	MAX	MIN	TYP	MAX	
SR	Slew rate at unity gain $R_L = 2$ k Ω , $C_L = 100$ pF, See Figure 1	25°C	1.7	2.8		1.7	2.8	V/ μ s	
		Full range	1.2			1.2			
V_n	Equivalent input noise voltage (see Figure 2) $R_S = 20$ Ω , $f = 10$ Hz $R_S = 20$ Ω , $f = 1$ kHz	25°C		3.3	8		3.3	4.5	nV/ $\sqrt{\text{Hz}}$
				2.5	4.5		2.5	3.8	
$V_{N(PP)}$	Peak-to-peak equivalent input noise voltage $f = 0.1$ Hz to 10 Hz	25°C		50	250		50	130	nV
I_n	Equivalent input noise current $f = 10$ Hz $f = 1$ kHz	25°C		1.5	4		1.5	4	pA/ $\sqrt{\text{Hz}}$
				0.4	0.6		0.4	0.6	
THD	Total harmonic distortion $V_O = +10$ V, $A_{VD} = 5$, See Note 5	25°C	<0.002%			<0.002%			
B_1	Unity-gain bandwidth (see Figure 3) $R_L = 2$ k Ω , $C_L = 100$ pF	25°C	7	13		9	13	MHz	
BOM	Maximum output-swing bandwidth $R_L = 2$ k Ω	25°C		30			30	kHz	
ϕ_m	Phase margin at unity gain (see Figure 3) $R_L = 2$ k Ω , $C_L = 100$ pF	25°C		55°			55°		

† Full range is 0°C to 70°C.

NOTE 5: Measured distortion of the source used in the analysis was 0.002%.



POST OFFICE BOX 655303 • DALLAS, TEXAS 75265

TLE2027, TLE2027A, TLE2027Y
EXCALIBUR LOW-NOISE HIGH-SPEED
PRECISION OPERATIONAL AMPLIFIERS

SLOS054D – MAY 1990 – REVISED SEPTEMBER 1996

electrical characteristics at specified free-air temperature, $V_{CC\pm} = \pm 15$ V (unless otherwise noted)

PARAMETER	TEST CONDITIONS	T_A †	TLE2027I			TLE2027AI			UNIT
			MIN	TYP	MAX	MIN	TYP	MAX	
V_{IO} Input offset voltage	$V_{IC} = 0, R_S = 50 \Omega$	25°C	20		100	10		25	μV
		Full range	180			105			
α_{VIO} Temperature coefficient of input offset voltage		Full range	0.4		1	0.2		1	$\mu V/^\circ C$
Input offset voltage long-term drift (see Note 4)		25°C	0.006		1	0.006		1	$\mu V/mo$
I_{IO} Input offset current		25°C	6		90	6		90	nA
		Full range	150			150			
I_{IB} Input bias current	25°C	15		90	15		90	nA	
	Full range	150			150				
V_{ICR} Common-mode input voltage range	$R_S = 50 \Omega$	25°C	-11 to 11	-13 to 13	-11 to 11	-13 to 13	V		
		Full range	-10.4 to 10.4		-10.4 to 10.4				
V_{OM+} Maximum positive peak output voltage swing	$R_L = 600 \Omega$	25°C	10.5			V			
		Full range	10						
	$R_L = 2 k\Omega$	25°C	12						
		Full range	11						
V_{OM-} Maximum negative peak output voltage swing	$R_L = 600 \Omega$	25°C	-10.5	-13	-10.5	-13	V		
		Full range	-10		-10				
	$R_L = 2 k\Omega$	25°C	-12	-13.5	-12	-13.5			
		Full range	-11		-11				
A_{VD} Large-signal differential voltage amplification	$V_O = \pm 11$ V, $R_L = 2 k\Omega$	25°C	5	45	10	45	V/ μV		
	$V_O = \pm 10$ V, $R_L = 2 k\Omega$	Full range	2		3.5				
	$V_O = \pm 10$ V, $R_L = 1 k\Omega$	25°C	3.5	38	8	38			
		Full range	1		2.2				
	$V_O = \pm 10$ V, $R_L = 600 \Omega$	25°C	2	19	5	19			
		Full range	0.5		1.1				
C_i Input capacitance		25°C	8			8			pF
z_o Open-loop output impedance	$I_O = 0$	25°C	50			50			Ω
CMRR Common-mode rejection ratio	$V_{IC} = V_{ICRmin}, R_S = 50 \Omega$	25°C	100	131	117	131	dB		
		Full range	96			113			
k_{SVR} Supply-voltage rejection ratio ($\Delta V_{CC\pm} / \Delta V_{IO}$)	$V_{CC\pm} = \pm 4$ V to ± 18 V, $R_S = 50 \Omega$	25°C	94	144	110	144	dB		
	$V_{CC\pm} = \pm 4$ V to ± 18 V, $R_S = 50 \Omega$	Full range	90		105				
I_{CC} Supply current	$V_O = 0, \text{ No load}$	25°C	3.8	5.3	3.8	5.3	mA		
		Full range	5.6			5.6			

† Full range is -40°C to 105°C.

NOTE 4: Typical values are based on the input offset voltage shift observed through 168 hours of operating life test at $T_A = 150^\circ C$ extrapolated to $T_A = 25^\circ C$ using the Arrhenius equation and assuming an activation energy of 0.96 eV.



POST OFFICE BOX 655303 • DALLAS, TEXAS 75265

TLE2027, TLE2027A, TLE2027Y
EXCALIBUR LOW-NOISE HIGH-SPEED
PRECISION OPERATIONAL AMPLIFIERS

SLOS054D – MAY 1990 – REVISED SEPTEMBER 1996

operating characteristics at specified free-air temperature, $V_{CC} \pm = \pm 15$ V

PARAMETER	TEST CONDITIONS	T_A †	TLE2027I			TLE2027AI			UNIT
			MIN	TYP	MAX	MIN	TYP	MAX	
SR	Slew rate at unity gain $R_L = 2$ k Ω , $C_L = 100$ pF, See Figure 1	25°C	1.7	2.8		1.7	2.8		V/ μ s
		Full range	1.1			1.1			
V_n	Equivalent input noise voltage (see Figure 2) $R_S = 20$ Ω , $f = 10$ Hz $R_S = 20$ Ω , $f = 1$ kHz	25°C		3.3	8		3.3	4.5	nV/ $\sqrt{\text{Hz}}$
				2.5	4.5		2.5	3.8	
$V_{N(PP)}$	Peak-to-peak equivalent input noise voltage $f = 0.1$ Hz to 10 Hz	25°C		50	250		50	130	nV
I_n	Equivalent input noise current $f = 10$ Hz $f = 1$ kHz	25°C		1.5	4		1.5	4	pA/ $\sqrt{\text{Hz}}$
				0.4	0.6		0.4	0.6	
THD	Total harmonic distortion $V_O = +10$ V, $A_{VD} = 1$, See Note 5	25°C	< 0.002%			< 0.002%			
B_1	Unity-gain bandwidth (see Figure 3) $R_L = 2$ k Ω , $C_L = 100$ pF	25°C	7	13		9	13		MHz
BOM	Maximum output-swing bandwidth $R_L = 2$ k Ω	25°C		30			30		kHz
ϕ_m	Phase margin at unity gain (see Figure 3) $R_L = 2$ k Ω , $C_L = 100$ pF	25°C		55°			55°		

† Full range is – 40°C to 105°C.

NOTE 5: Measured distortion of the source used in the analysis was 0.002%.



POST OFFICE BOX 655303 • DALLAS, TEXAS 75265

TLE2027, TLE2027A, TLE2027Y
EXCALIBUR LOW-NOISE HIGH-SPEED
PRECISION OPERATIONAL AMPLIFIERS

SLOS054D – MAY 1990 – REVISED SEPTEMBER 1996

electrical characteristics at specified free-air temperature, $V_{CC\pm} = \pm 15\text{ V}$ (unless otherwise noted)

PARAMETER	TEST CONDITIONS	T_A †	TLE2027M			TLE2027AM			UNIT
			MIN	TYP	MAX	MIN	TYP	MAX	
V_{IO} Input offset voltage	$V_{IC} = 0, R_S = 50\ \Omega$	25°C	20		100	10		25	μV
		Full range	200			105			
α_{VIO} Temperature coefficient of input offset voltage		Full range	0.4		1*	0.2		1*	$\mu\text{V}/^\circ\text{C}$
Input offset voltage long-term drift (see Note 4)		25°C	0.006		1*	0.006		1*	$\mu\text{V}/\text{mo}$
I_{IO} Input offset current		25°C	6		90	6		90	nA
		Full range	150			150			
I_{IB} Input bias current	25°C	15		90	15		90	nA	
	Full range	150			150				
V_{ICR} Common-mode input voltage range	$R_S = 50\ \Omega$	25°C	-11 to 11		-13 to 13		-11 to 11		V
		Full range	-10.3 to 10.3		-10.4 to 10.4				
V_{OM+} Maximum positive peak output voltage swing	$R_L = 600\ \Omega$	25°C	10.5			10.5			V
		Full range	10			10			
	$R_L = 2\ \text{k}\Omega$	25°C	12			12			
		Full range	11			11			
V_{OM-} Maximum negative peak output voltage swing	$R_L = 600\ \Omega$	25°C	-10.5		-13	-10.5		-13	V
		Full range	-10			-10			
	$R_L = 2\ \text{k}\Omega$	25°C	-12		-13.5	-12		-13.5	
		Full range	-11			-11			
AVD Large-signal differential voltage amplification	$V_O = \pm 11\ \text{V}, R_L = 2\ \text{k}\Omega$	25°C	5		45	10		45	V/ μV
	$V_O = \pm 10\ \text{V}, R_L = 2\ \text{k}\Omega$	Full range	2.5			3.5			
	$V_O = \pm 10\ \text{V}, R_L = 1\ \text{k}\Omega$	25°C	3.5		38	8		38	
		Full range	1.8			2.2			
	$V_O = \pm 10\ \text{V}, R_L = 600\ \Omega$	25°C	2		19	5		19	
C_i Input capacitance		25°C	8			8			pF
z_o Open-loop output impedance	$I_O = 0$	25°C	50			50			Ω
CMRR Common-mode rejection ratio	$V_{IC} = V_{ICRmin}, R_S = 50\ \Omega$	25°C	100		131	117		131	dB
		Full range	96			113			
k_{SVR} Supply-voltage rejection ratio ($\Delta V_{CC\pm} / \Delta V_{IO}$)	$V_{CC\pm} = \pm 4\ \text{V to } \pm 18\ \text{V}, R_S = 50\ \Omega$	25°C	94		144	110		144	dB
	$V_{CC\pm} = \pm 4\ \text{V to } \pm 18\ \text{V}, R_S = 50\ \Omega$	Full range	90			105			
I_{CC} Supply current	$V_O = 0, \text{ No load}$	25°C	3.8		5.3	3.8		5.3	mA
		Full range	5.6			5.6			

* On products compliant to MIL-PRF-38535, this parameter is not production tested.

† Full range is -55°C to 125°C .

NOTE 4: Typical values are based on the input offset voltage shift observed through 168 hours of operating life test at $T_A = 150^\circ\text{C}$ extrapolated to $T_A = 25^\circ\text{C}$ using the Arrhenius equation and assuming an activation energy of 0.96 eV.



POST OFFICE BOX 655303 • DALLAS, TEXAS 75265

TLE2027, TLE2027A, TLE2027Y
EXCALIBUR LOW-NOISE HIGH-SPEED
PRECISION OPERATIONAL AMPLIFIERS

SLOS054D – MAY 1990 – REVISED SEPTEMBER 1996

operating characteristics at specified free-air temperature, $V_{CC} \pm = \pm 15$ V

PARAMETER	TEST CONDITIONS	T_A †	TLE2027M			TLE2027AM			UNIT
			MIN	TYP	MAX	MIN	TYP	MAX	
SR	Slew rate at unity gain $R_L = 2$ k Ω , $C_L = 100$ pF, See Figure 1	25°C	1.7	2.8		1.7	2.8		V/ μ s
		Full range	1			1			
V_n	Equivalent input noise voltage (see Figure 2) $R_S = 20$ Ω , $f = 10$ Hz $R_S = 20$ Ω , $f = 1$ kHz	25°C		3.3	8*		3.3	4.5*	nV/ $\sqrt{\text{Hz}}$
				2.5	4.5*		2.5	3.8*	
$V_{N(PP)}$	Peak-to-peak equivalent input noise voltage $f = 0.1$ Hz to 10 Hz	25°C		50	250*		50	130*	nV
I_n	Equivalent input noise current $f = 10$ Hz $f = 1$ kHz	25°C		1.5	4*		1.5	4*	pA/ $\sqrt{\text{Hz}}$
				0.4	0.6*		0.4	0.6*	
THD	Total harmonic distortion $V_O = +10$ V, $A_{VD} = 1$, See Note 5	25°C	< 0.002%			< 0.002%			
B_1	Unity-gain bandwidth (see Figure 3) $R_L = 2$ k Ω , $C_L = 100$ pF	25°C	7*	13		9*	13		MHz
BOM	Maximum output-swing bandwidth $R_L = 2$ k Ω	25°C		30			30		kHz
ϕ_m	Phase margin at unity gain (see Figure 3) $R_L = 2$ k Ω , $C_L = 100$ pF	25°C		55°			55°		

* On products compliant to MIL-PRF-38535, this parameter is not production tested.

† Full range is – 55°C to 125°C.

NOTE 5: Measured distortion of the source used in the analysis was 0.002%.



POST OFFICE BOX 655303 • DALLAS, TEXAS 75265

8961724 0103607 127

TLE2027, TLE2027A, TLE2027Y
EXCALIBUR LOW-NOISE HIGH-SPEED
PRECISION OPERATIONAL AMPLIFIERS

SLOS054D – MAY 1990 – REVISED SEPTEMBER 1996

electrical characteristics, $V_{CC\pm} = \pm 15\text{ V}$, $T_A = 25^\circ\text{C}$ (unless otherwise noted)

PARAMETER	TEST CONDITIONS	TLE2027Y			UNIT
		MIN	TYP	MAX	
V_{IO} Input offset voltage	$V_{IC} = 0$, $R_S = 50\ \Omega$		20	100	μV
Input offset voltage long-term drift (see Note 4)			0.006		$\mu\text{V}/\text{mo}$
I_{IO} Input offset current			6		nA
I_{IB} Input bias current			15		nA
V_{ICR} Common-mode input voltage range	$R_S = 50\ \Omega$		-13 to 13		V
V_{OM} – Maximum negative peak output voltage swing	$R_L = 600\ \Omega$		-13		V
	$R_L = 2\ \text{k}\Omega$		-13.5		
A_{VD} Large-signal differential voltage amplification	$V_O = \pm 11\ \text{V}$, $R_L = 2\ \text{k}\Omega$		45		V/ μV
	$V_O = \pm 10\ \text{V}$, $R_L = 1\ \text{k}\Omega$		38		
	$V_O = \pm 10\ \text{V}$, $R_L = 600\ \Omega$		19		
C_i Input capacitance			8		pF
z_o Open-loop output impedance	$I_O = 0$		50		Ω
CMRR Common-mode rejection ratio	$V_{IC} = V_{ICR\text{min}}$, $R_S = 50\ \Omega$		131		dB
k_{SVR} Supply-voltage rejection ratio ($\Delta V_{CC\pm} / \Delta V_{IO}$)	$V_{CC\pm} = \pm 4\ \text{V}$ to $\pm 18\ \text{V}$, $R_S = 50\ \Omega$		144		dB
I_{CC} Supply current	$V_O = 0$, No load		3.8		mA

NOTE 4: Typical values are based on the input offset voltage shift observed through 168 hours of operating life test at $T_A = 150^\circ\text{C}$ extrapolated to $T_A = 25^\circ\text{C}$ using the Arrhenius equation and assuming an activation energy of 0.96 eV.



POST OFFICE BOX 655303 • DALLAS, TEXAS 75265

TLE2027, TLE2027A, TLE2027Y
EXCALIBUR LOW-NOISE HIGH-SPEED
PRECISION OPERATIONAL AMPLIFIERS

SLOS054D – MAY 1990 – REVISED SEPTEMBER 1996

operating characteristics at specified free-air temperature, $V_{CC} \pm = \pm 15\text{ V}$

PARAMETER		TEST CONDITIONS	TLE2027Y			UNIT
			MIN	TYP	MAX	
SR	Slew rate at unity gain	$R_L = 2\text{ k}\Omega$, $C_L = 100\text{ pF}$, See Figure 1		2.8		$\text{V}/\mu\text{s}$
V_n	Equivalent input noise voltage (see Figure 2)	$R_S = 20\ \Omega$, $f = 10\text{ Hz}$		3.3		$\text{nV}/\sqrt{\text{Hz}}$
		$R_S = 20\ \Omega$, $f = 1\text{ kHz}$		2.5		
$V_{N(PP)}$	Peak-to-peak equivalent input noise voltage	$f = 0.1\text{ Hz to }10\text{ Hz}$		50		nV
I_n	Equivalent input noise current	$f = 10\text{ Hz}$		1.5		$\text{pA}/\sqrt{\text{Hz}}$
		$f = 1\text{ kHz}$		0.4		
THD	Total harmonic distortion	$V_O = +10\text{ V}$, $A_{VD} = 5$, See Note 5		<0.002%		
B_1	Unity-gain bandwidth (see Figure 3)	$R_L = 2\text{ k}\Omega$, $C_L = 100\text{ pF}$		13		MHz
B_{OM}	Maximum output-swing bandwidth	$R_L = 2\text{ k}\Omega$		30		kHz
ϕ_m	Phase margin at unity gain (see Figure 3)	$R_L = 2\text{ k}\Omega$, $C_L = 100\text{ pF}$		55°		

NOTE 5: Measured distortion of the source used in the analysis was 0.002%.



POST OFFICE BOX 655303 • DALLAS, TEXAS 75265

PARAMETER MEASUREMENT INFORMATION

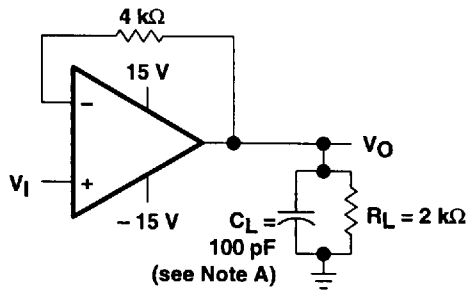

NOTE A: C_L includes fixture capacitance.

Figure 1. Slew-Rate Test Circuit

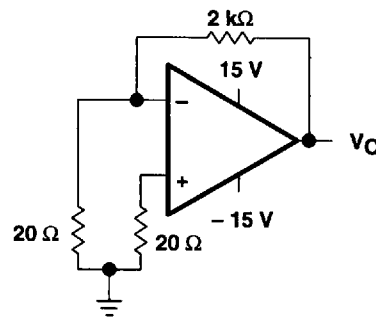
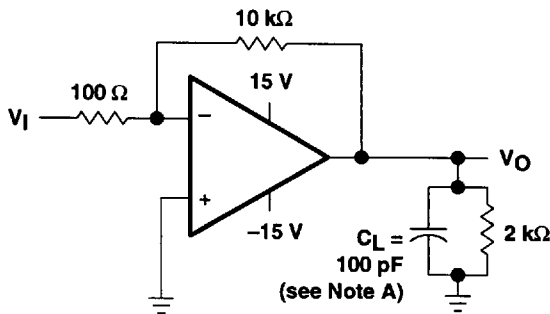
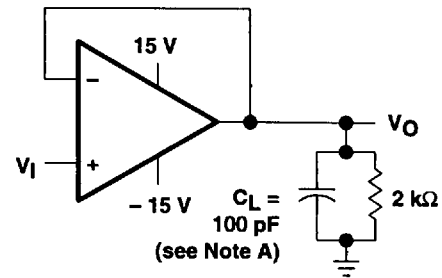

Figure 2. Noise-Voltage Test Circuit



NOTE A: C_L includes fixture capacitance.

Figure 3. Unity-Gain Bandwidth and Phase-Margin Test Circuit



NOTE A: C_L includes fixture capacitance.

Figure 4. Small-Signal Pulse-Response Test Circuit

typical values

Typical values presented in this data sheet represent the median (50% point) of device parametric performance.

initial estimates of parameter distributions

In the ongoing program of improving data sheets and supplying more information to our customers, Texas Instruments has added an estimate of not only the typical values but also the spread around these values. These are in the form of distribution bars that show the 95% (upper) points and the 5% (lower) points from the characterization of the initial wafer lots of this new device type (see Figure 5). The distribution bars are shown at the points where data was actually collected. The 95% and 5% points are used instead of ± 3 sigma since some of the distributions are not true Gaussian distributions.

The number of units tested and the number of different wafer lots used are on all of the graphs where distribution bars are shown. As noted in Figure 5, there were a total of 835 units from two wafer lots. In this case, there is a good estimate for the within-lot variability and a possibly poor estimate of the lot-to-lot variability. This is always the case on newly released products since there can only be data available from a few wafer lots.

The distribution bars are not intended to replace the minimum and maximum limits in the electrical tables. Each distribution bar represents 90% of the total units tested at a specific temperature. While 10% of the units tested fell outside any given distribution bar, this should not be interpreted to mean that the same individual devices fell outside every distribution bar.

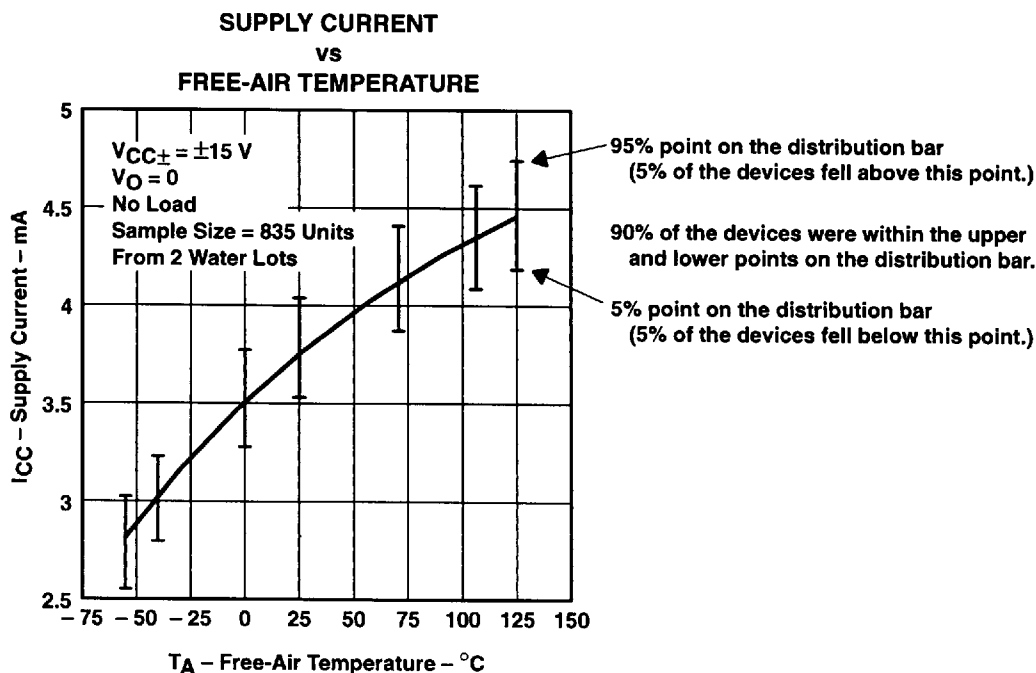

Figure 5. Sample Graph With Distribution Bars

TYPICAL CHARACTERISTICS

Table of Graphs

		FIGURE	
V_{IO}	Input offset voltage	Distribution	6
ΔV_{IO}	Input offset voltage change	vs Time after power on	7, 8
I_{IO}	Input offset current	vs Free-air temperature	9
I_{IB}	Input bias current	vs Common-mode input voltage	10
		vs Free-air temperature	11
I_I	Input current	vs Differential input voltage	12
$V_{O(PP)}$	Maximum peak-to-peak output voltage	vs Frequency	13
V_{OM}	Maximum (positive/negative) peak output voltage	vs Load resistance	14, 15
		vs Free-air temperature	16, 17
A_{VD}	Large-signal differential voltage amplification	vs Supply voltage	18
		vs Load resistance	19
		vs Frequency	20, 21
		vs Free-air temperature	22
z_o	Output impedance	vs Frequency	23
CMRR	Common-mode rejection ratio	vs Frequency	24
KSVR	Supply voltage rejection ratio	vs Frequency	25
I_{OS}	Short-circuit output current	vs Supply voltage	26, 27
		vs Elapsed time	28, 29
		vs Free-air temperature	30, 31
I_{CC}	Supply current	vs Supply voltage	32
		vs Free-air temperature	33
	Pulse response	Small signal	34
		Large signal	35
V_n	Equivalent input noise voltage	vs Frequency	36
		Noise voltage (referred to input)	vs Time
B_1	Unity-gain bandwidth	vs Supply voltage	38
		vs Load capacitance	39
SR	Slew rate	vs Free-air temperature	40
ϕ_m	Phase margin	vs Supply voltage	41
		vs Load capacitance	42
		vs Free-air temperature	43
	Phase shift	vs Frequency	20, 21



TYPICAL CHARACTERISTICS

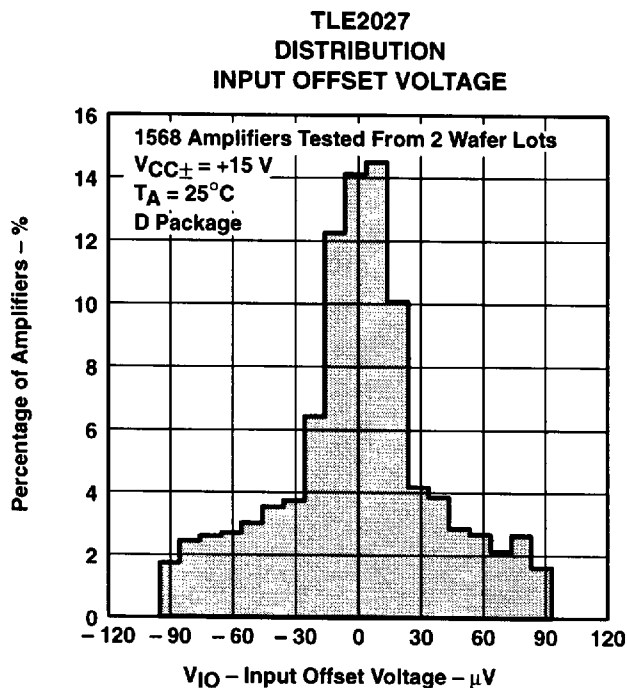

Figure 6

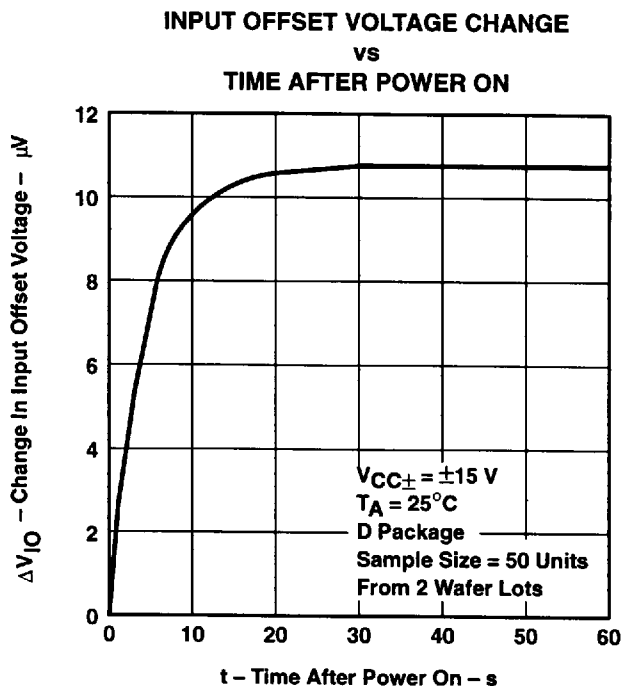

Figure 7

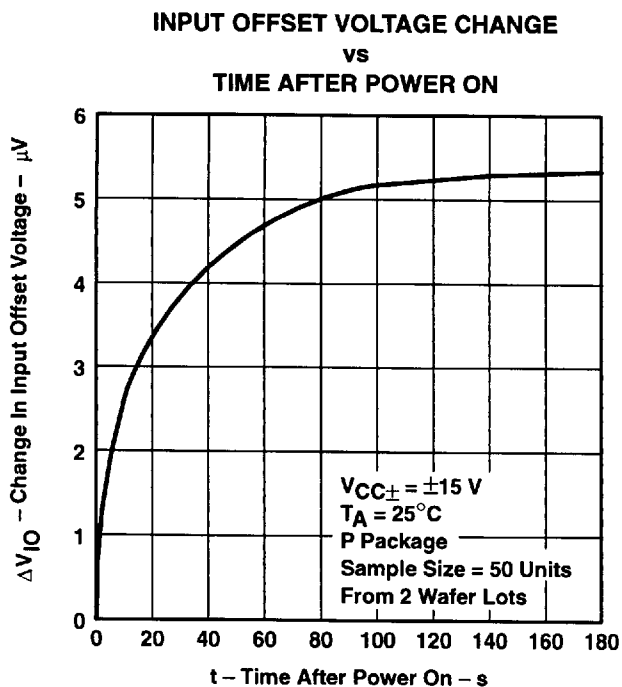
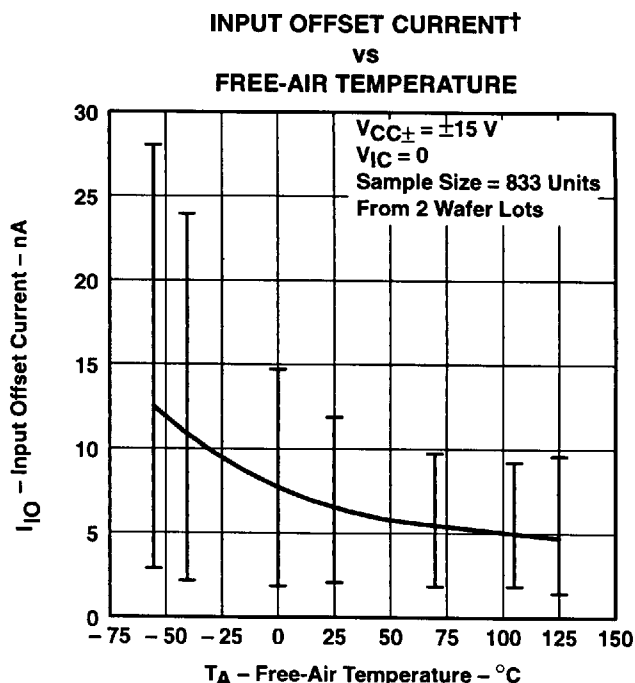

Figure 8



† Data at high and low temperatures are applicable only within the rated operating free-air temperature ranges of the various devices.

Figure 9

TYPICAL CHARACTERISTICS

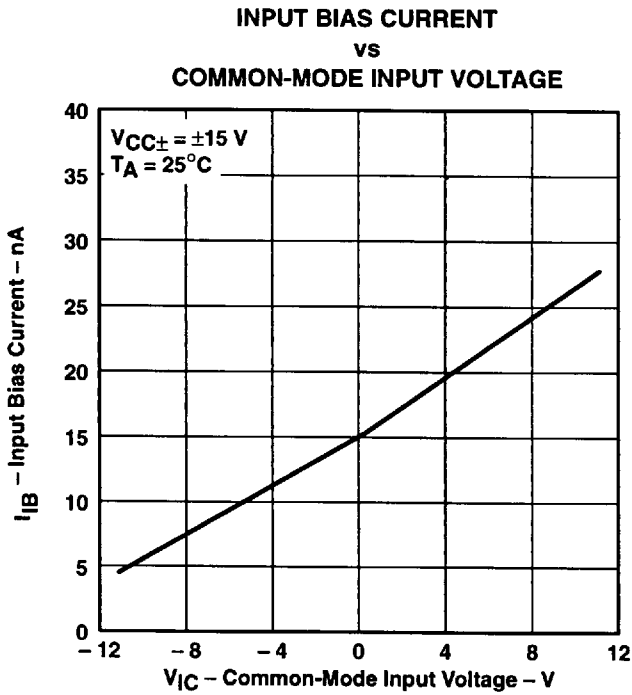
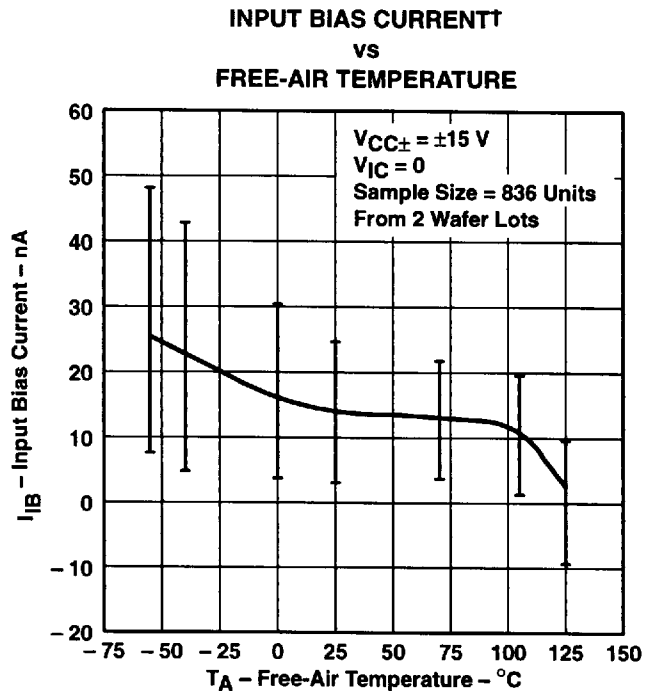

Figure 10



† Data at high and low temperatures are applicable only within the rated operating free-air temperature ranges of the various devices.

Figure 11

TYPICAL CHARACTERISTICS

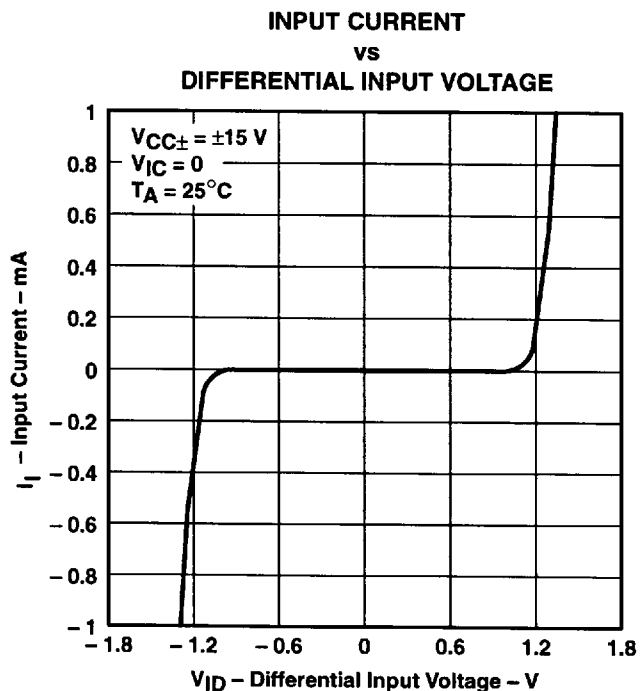
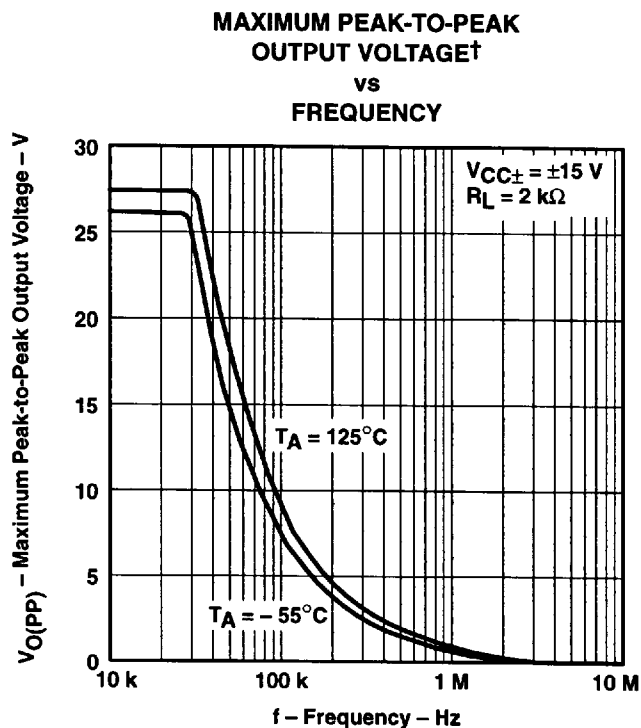

Figure 12



† Data at high and low temperatures are applicable only within the rated operating free-air temperature ranges of the various devices.

Figure 13

TYPICAL CHARACTERISTICS

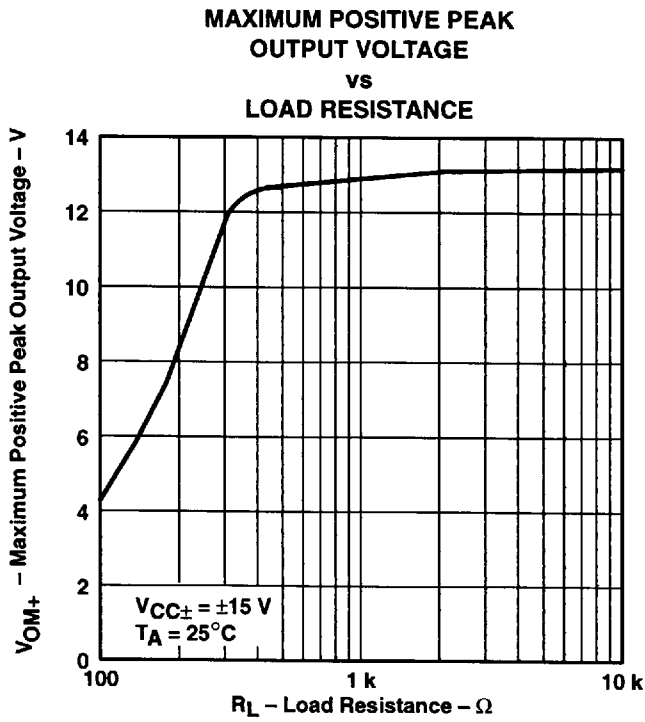

Figure 14

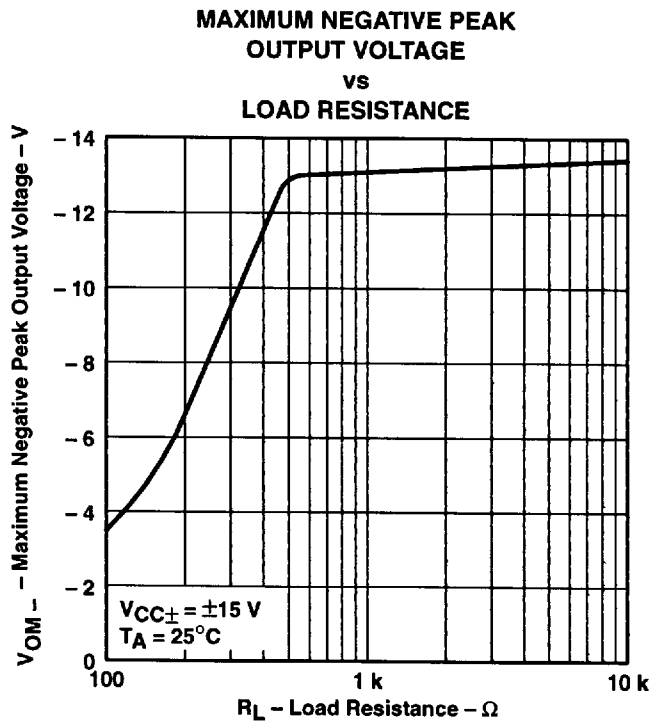
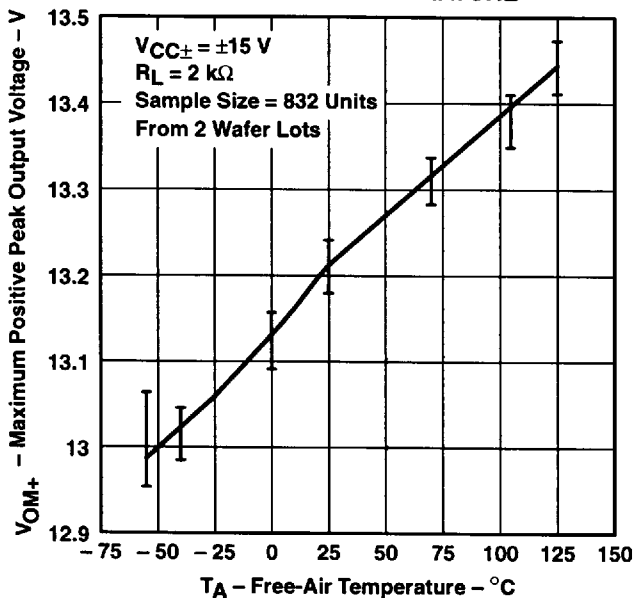

Figure 15

TYPICAL CHARACTERISTICS

MAXIMUM POSITIVE PEAK
 OUTPUT VOLTAGE†
 vs
 FREE-AIR TEMPERATURE



† Data at high and low temperatures are applicable only within the rated operating free-air temperature ranges of the various devices.

Figure 16

MAXIMUM NEGATIVE PEAK
 OUTPUT VOLTAGE†
 vs
 FREE-AIR TEMPERATURE

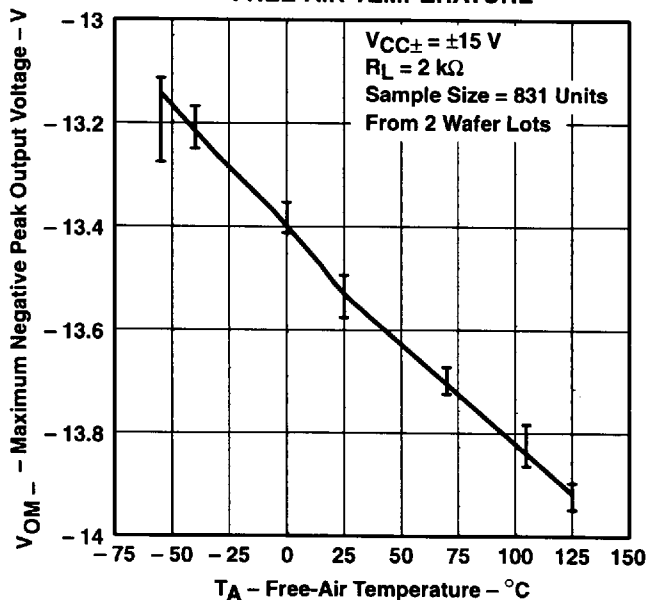

† Data at high and low temperatures are applicable only within the rated operating free-air temperature ranges of the various devices.

Figure 17

TLE2027, TLE2027A, TLE2027Y
EXCALIBUR LOW-NOISE HIGH-SPEED
PRECISION OPERATIONAL AMPLIFIERS

SLOS054D – MAY 1990 – REVISED SEPTEMBER 1996

TYPICAL CHARACTERISTICS

LARGE-SIGNAL DIFFERENTIAL VOLTAGE AMPLIFICATION vs SUPPLY VOLTAGE

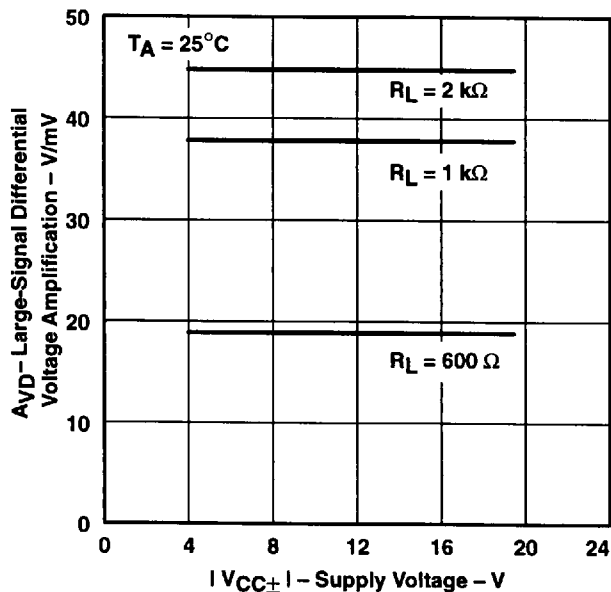

Figure 18

LARGE-SIGNAL DIFFERENTIAL VOLTAGE AMPLIFICATION vs LOAD RESISTANCE

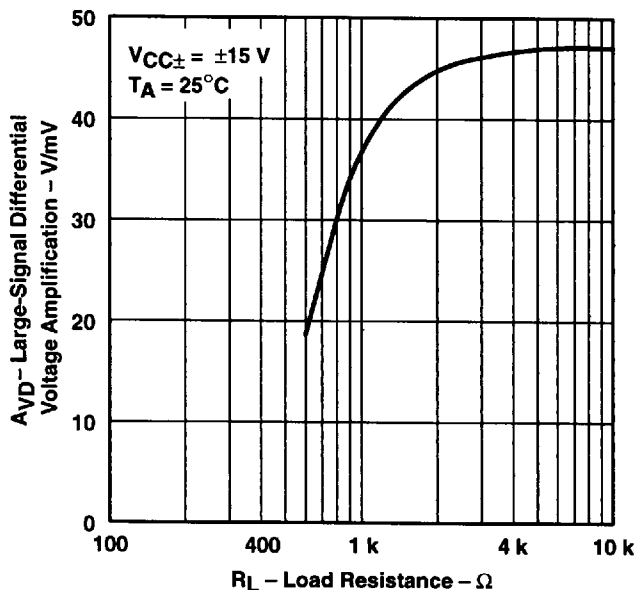

Figure 19

LARGE-SIGNAL DIFFERENTIAL VOLTAGE AMPLIFICATION AND PHASE SHIFT vs FREQUENCY

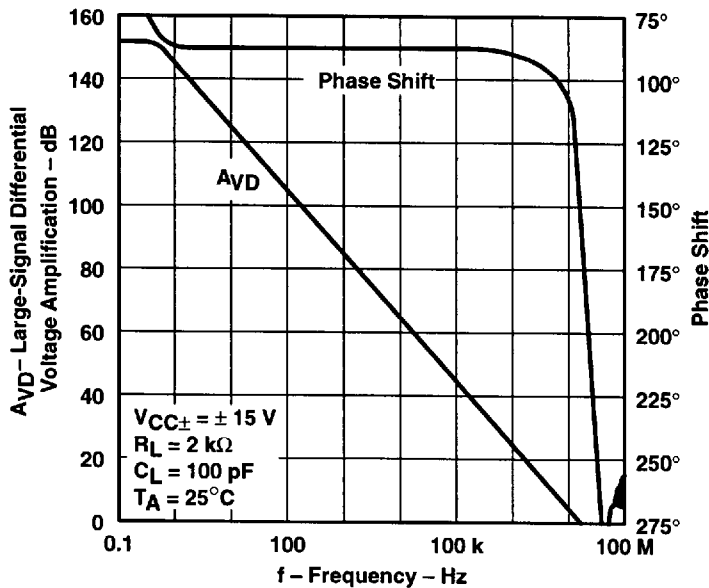

Figure 20



POST OFFICE BOX 655303 • DALLAS, TEXAS 75265

TYPICAL CHARACTERISTICS

LARGE-SIGNAL DIFFERENTIAL VOLTAGE
 AMPLIFICATION AND PHASE SHIFT
 vs
 FREQUENCY

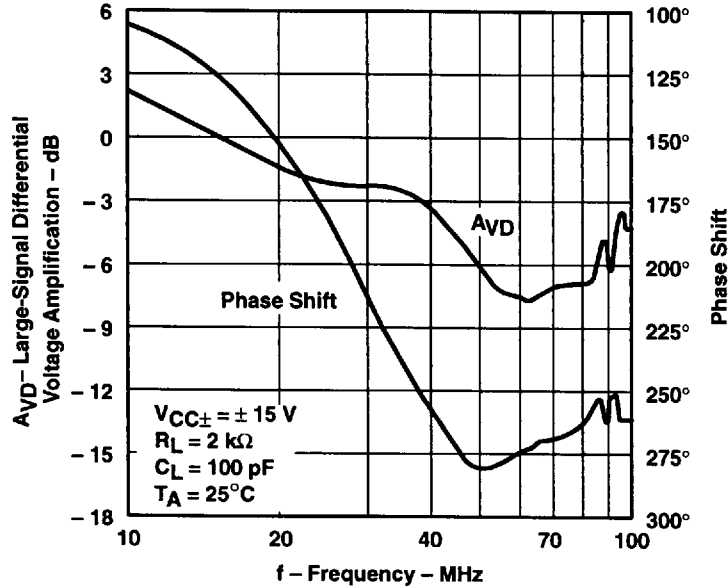

Figure 21

TLE2027, TLE2027A, TLE2027Y
EXCALIBUR LOW-NOISE HIGH-SPEED
PRECISION OPERATIONAL AMPLIFIERS

SLOS054D – MAY 1990 – REVISED SEPTEMBER 1996

TYPICAL CHARACTERISTICS

**LARGE-SIGNAL DIFFERENTIAL
 VOLTAGE AMPLIFICATION†
 VS
 FREE-AIR TEMPERATURE**

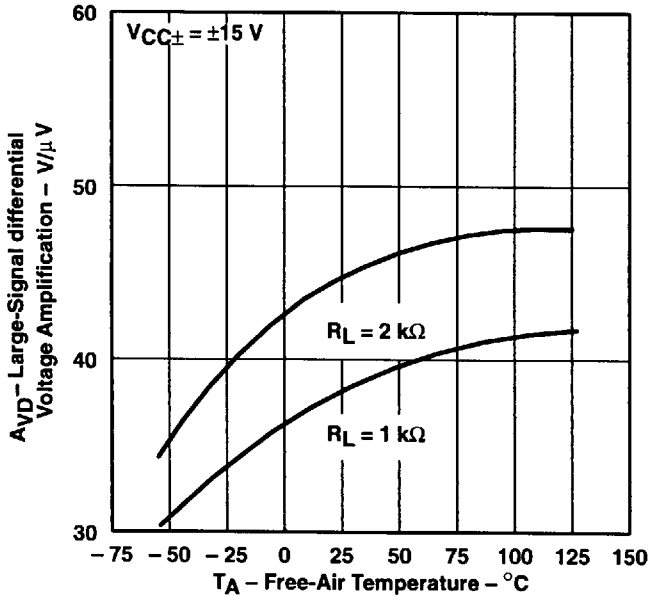

**OUTPUT IMPEDANCE
 VS
 FREQUENCY**

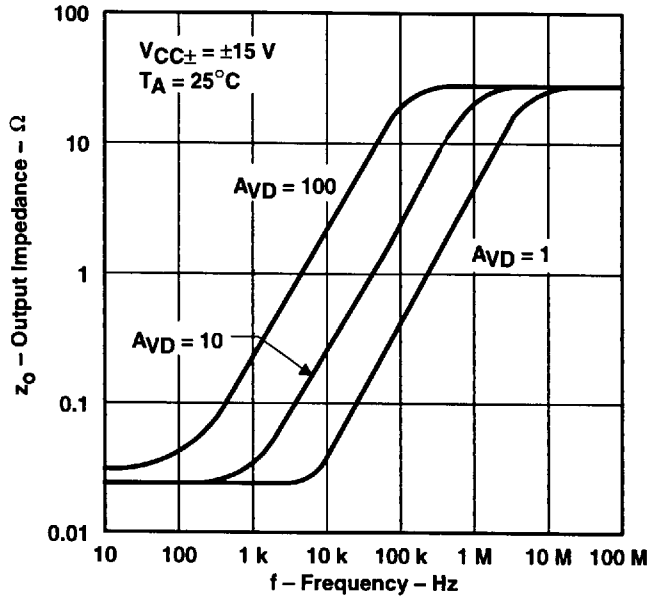

† Data at high and low temperatures are applicable only within the rated operating free-air temperature ranges of the various devices.

Figure 22

Figure 23



POST OFFICE BOX 655303 • DALLAS, TEXAS 75265

TYPICAL CHARACTERISTICS

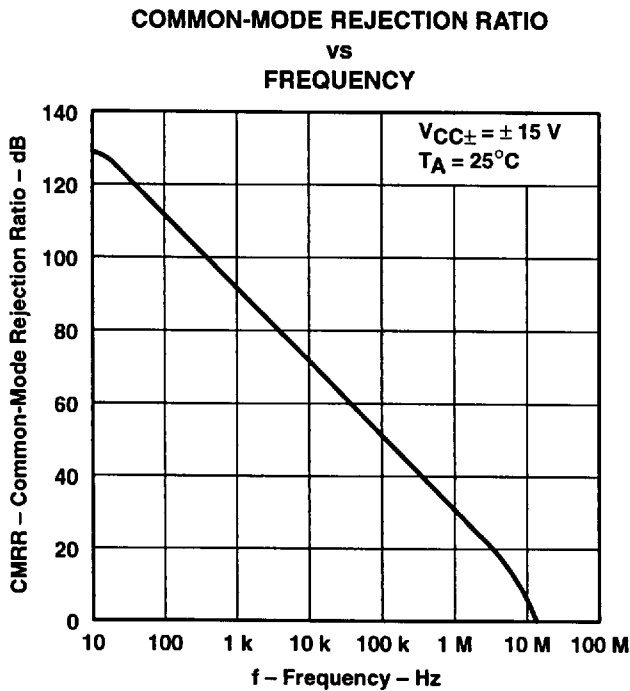

Figure 24

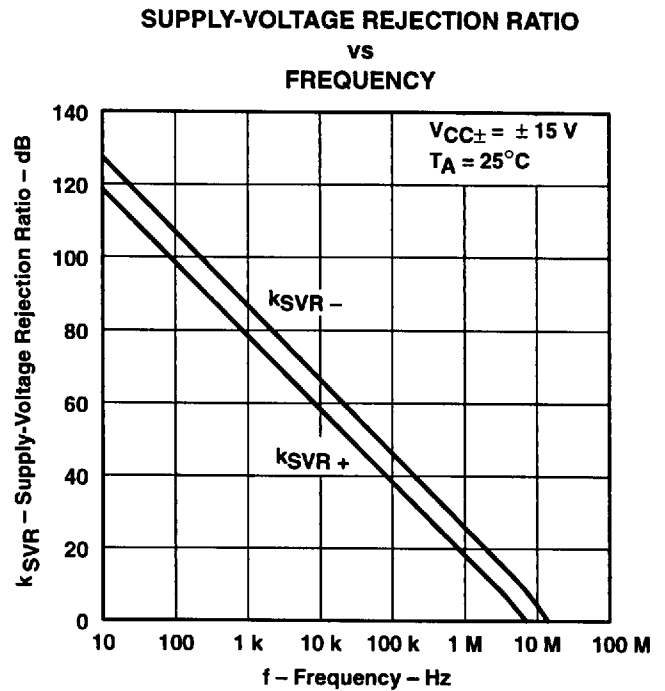

Figure 25

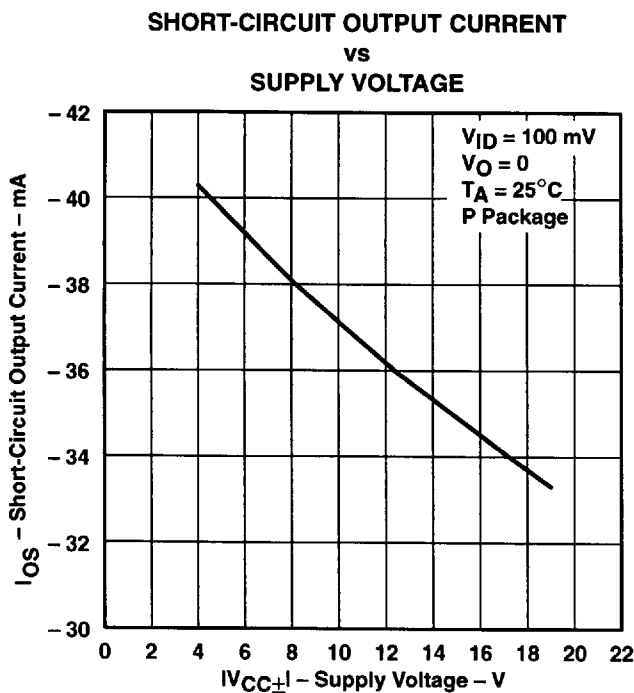

Figure 26

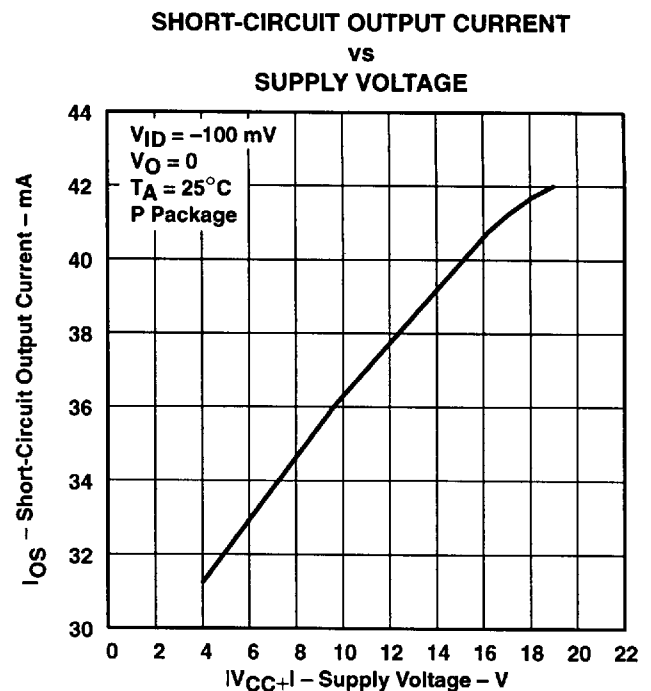

Figure 27

TLE2027, TLE2027A, TLE2027Y
EXCALIBUR LOW-NOISE HIGH-SPEED
PRECISION OPERATIONAL AMPLIFIERS

SLOS054D – MAY 1990 – REVISED SEPTEMBER 1996

TYPICAL CHARACTERISTICS

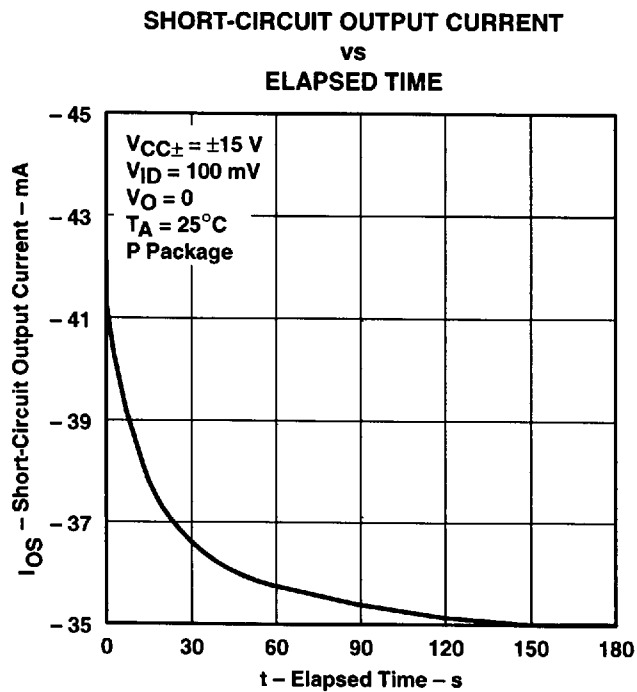

Figure 28

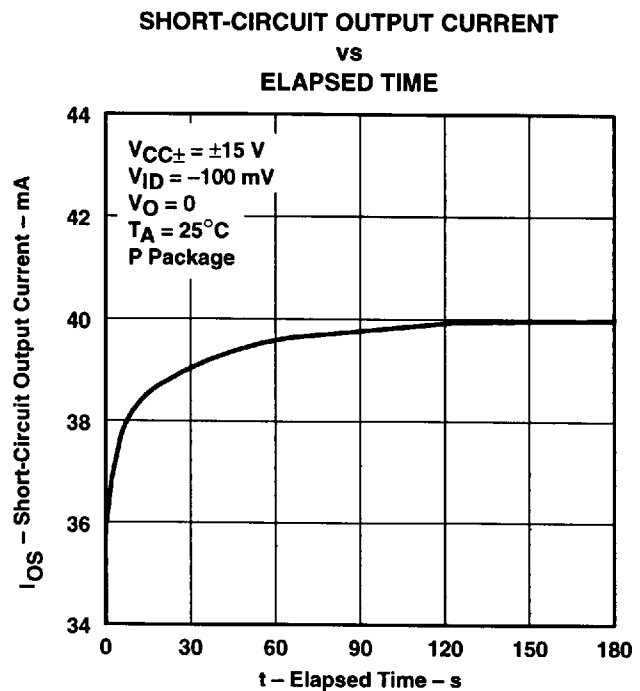

Figure 29

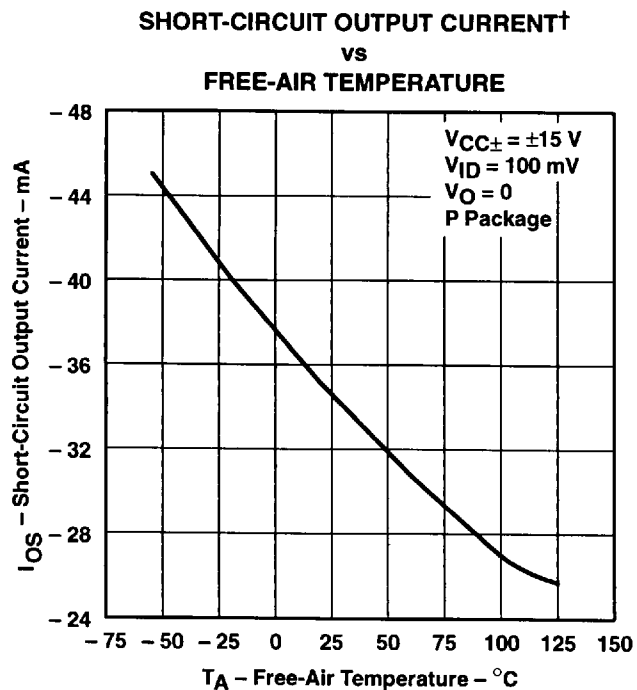

Figure 30

† Data at high and low temperatures are applicable only within the rated operating free-air temperature ranges of the various devices.

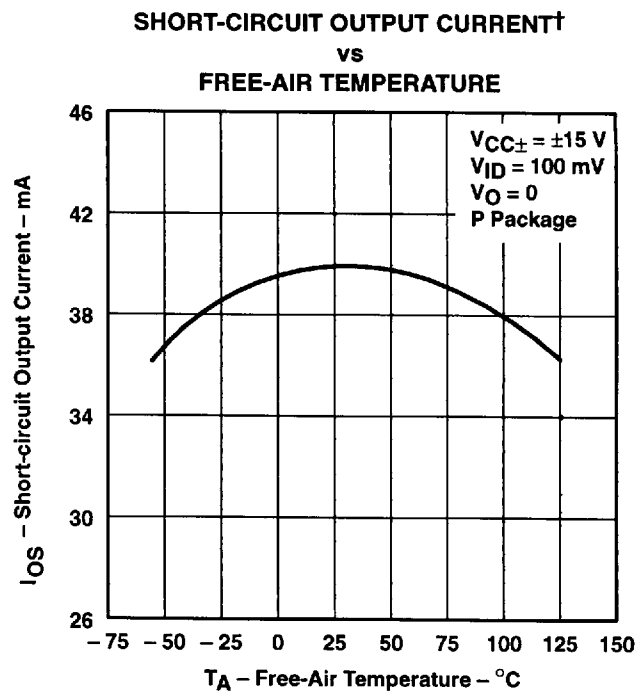

Figure 31

† Data at high and low temperatures are applicable only within the rated operating free-air temperature ranges of the various devices.



POST OFFICE BOX 655303 • DALLAS, TEXAS 75265

TYPICAL CHARACTERISTICS

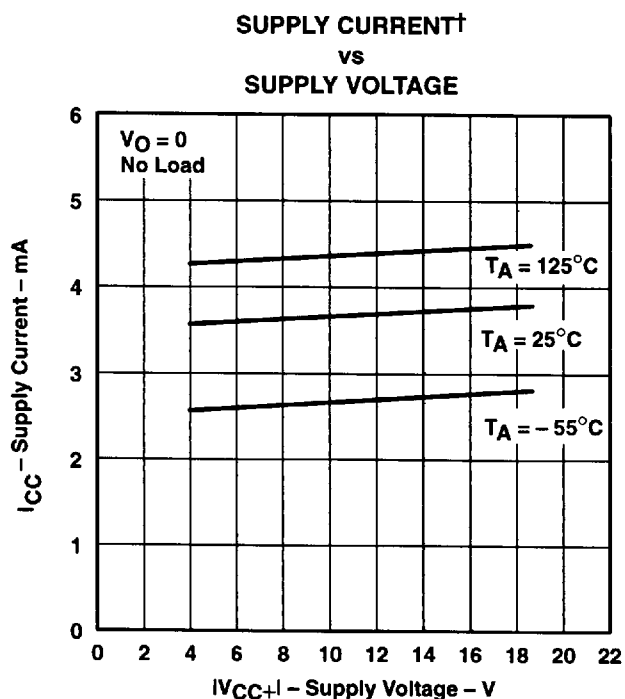

† Data at high and low temperatures are applicable only within the rated operating free-air temperature ranges of the various devices.

Figure 32

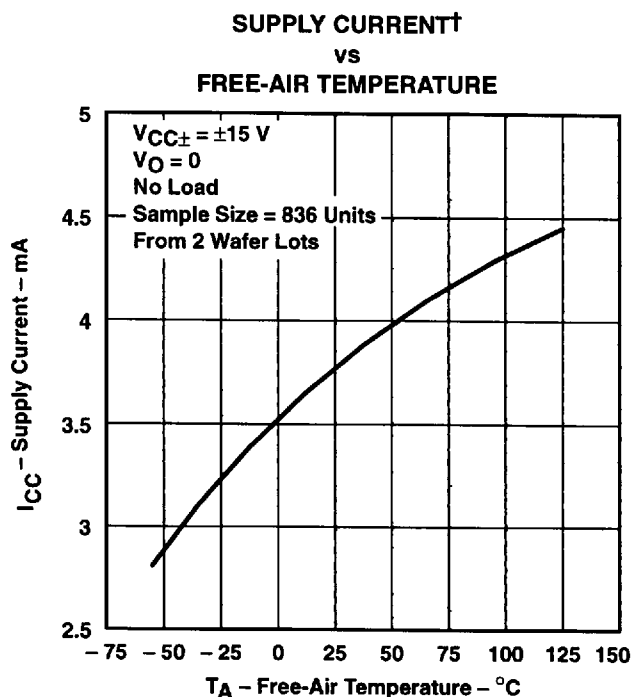

† Data at high and low temperatures are applicable only within the rated operating free-air temperature ranges of the various devices.

Figure 33

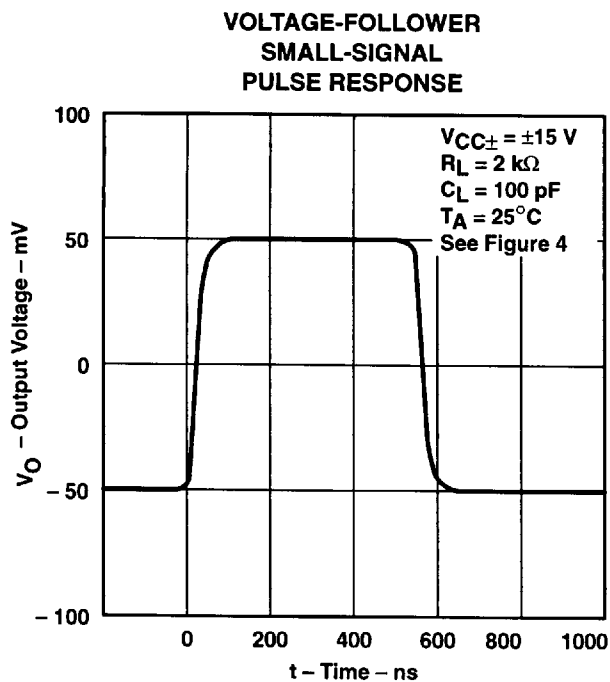

Figure 34

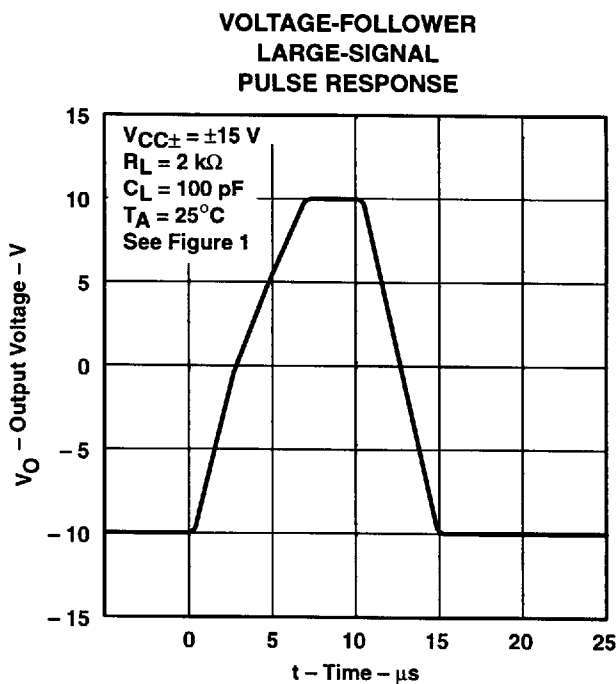

Figure 35

TYPICAL CHARACTERISTICS

EQUIVALENT INPUT NOISE VOLTAGE
 vs
 FREQUENCY

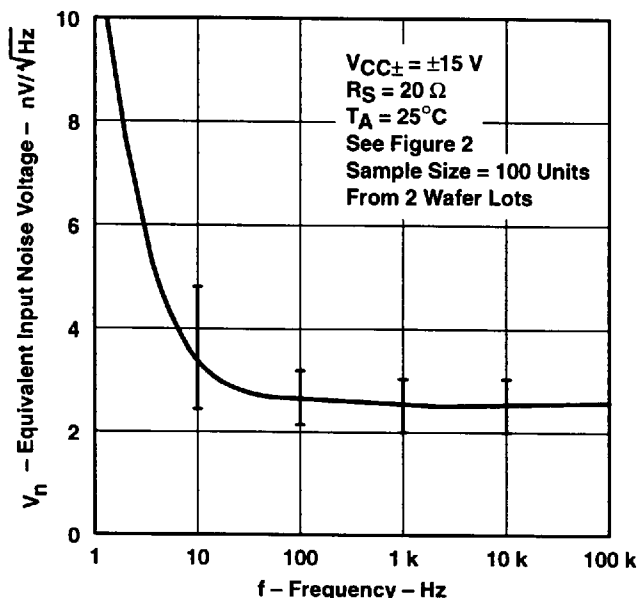

Figure 36

NOISE VOLTAGE
 (REFERRED TO INPUT)
 OVER A 10-SECOND INTERVAL

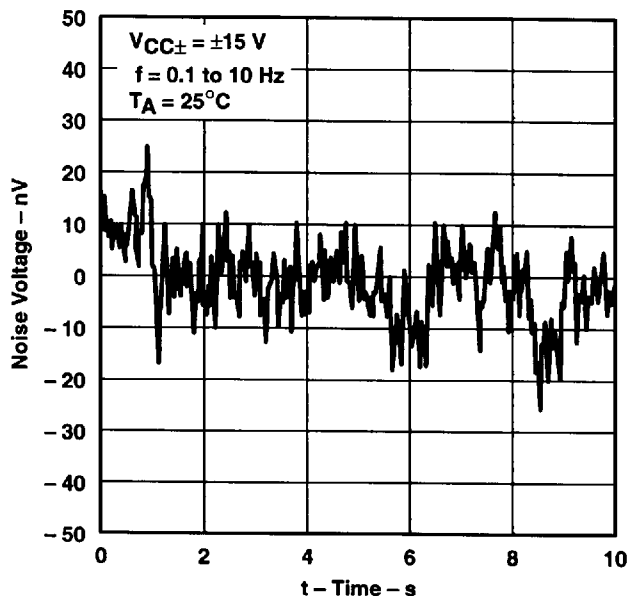

Figure 37

UNITY-GAIN BANDWIDTH
 vs
 SUPPLY VOLTAGE

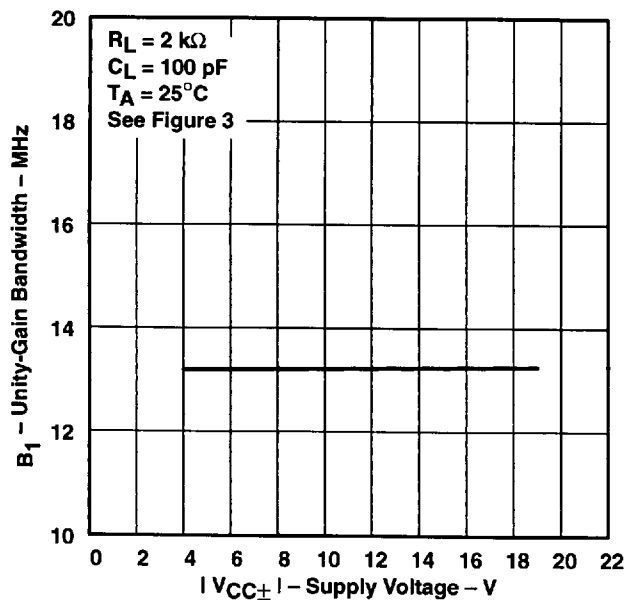

Figure 38

UNITY-GAIN BANDWIDTH
 vs
 LOAD CAPACITANCE

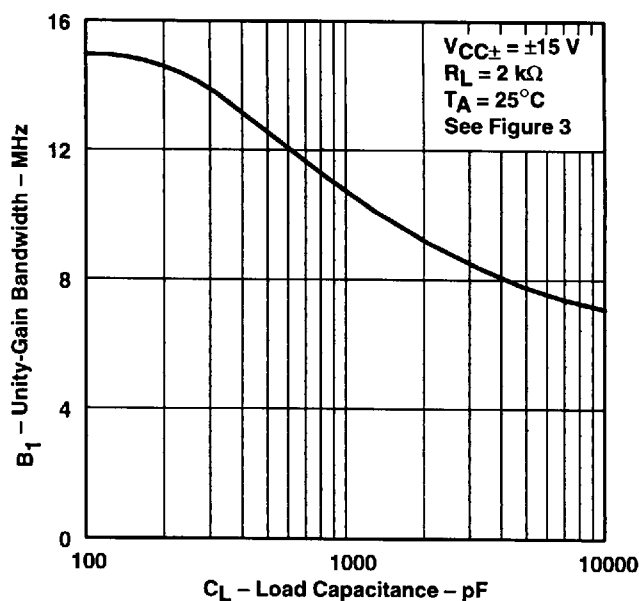

Figure 39

TYPICAL CHARACTERISTICS

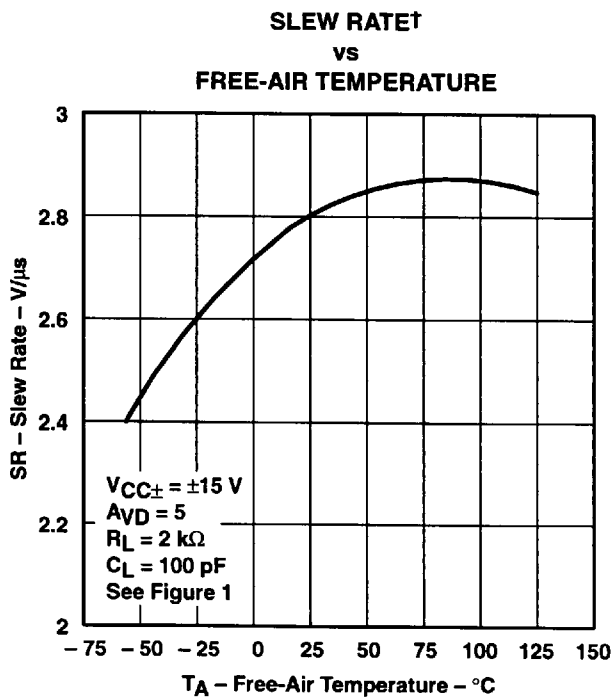

Figure 40

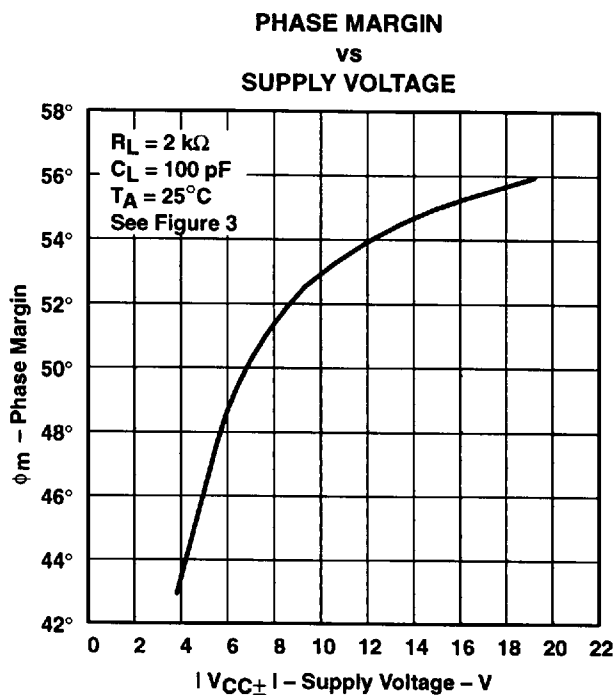

Figure 41

† Data at high and low temperatures are applicable only within the rated operating free-air temperature ranges of the various devices.

TYPICAL CHARACTERISTICS

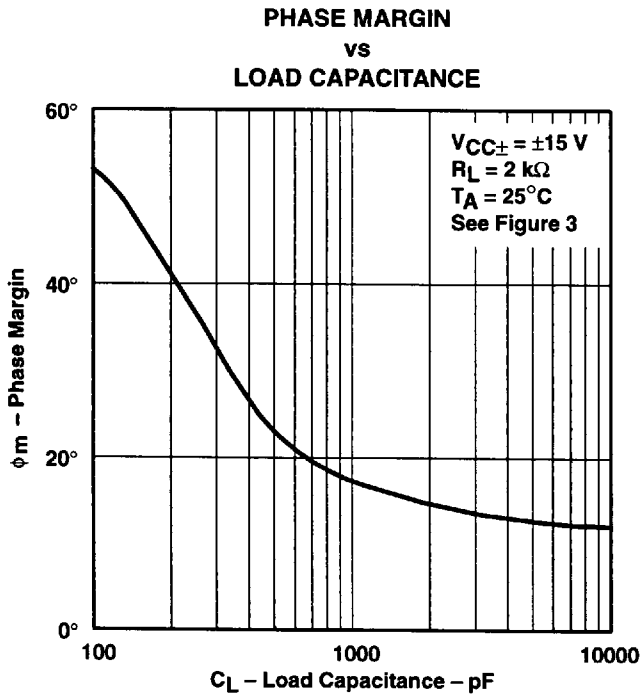
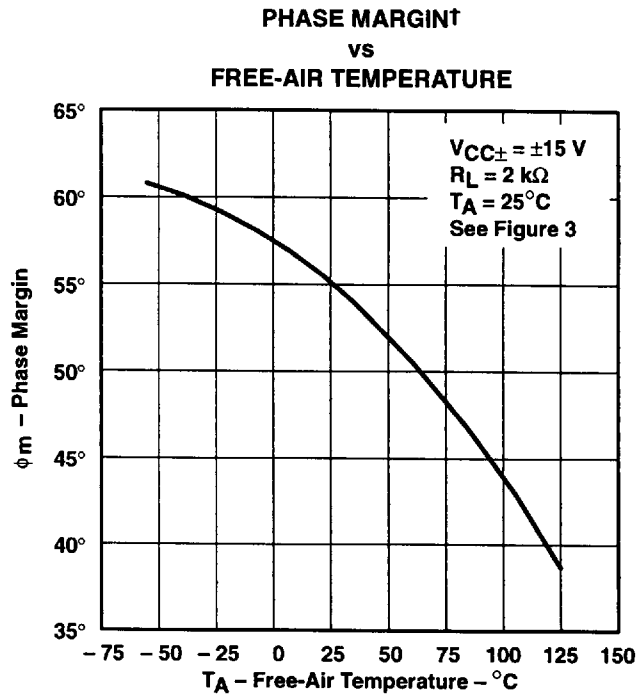

Figure 42



† Data at high and low temperatures are applicable only within the rated operating free-air temperature ranges of the various devices.

Figure 43

TLE2027, TLE2027A, TLE2027Y
EXCALIBUR LOW-NOISE HIGH-SPEED
PRECISION OPERATIONAL AMPLIFIERS

SLOS054D - MAY 1990 - REVISED SEPTEMBER 1996

APPLICATION INFORMATION

macromodel information (continued)

```
.subckt TLE2027 1 2 3 4 5
*
c1      11  12  4.003E-12
c2      6   7   20.00E-12
dc      5   53  dz
de      54  5   dz
dlp     90  91  dz
dln     92  90  dx
dp      4   3   dz
egnd    99  0   poly(2) (3,0) (4,0) 0 5 .5
fb      7   99  poly(5) vb vc ve vlp vln 0 954.8E6 -1E9 1E9 1E9 -1E9
ga      6   0   11 12  2.062E-3
gcm     0   6   10 99  531.3E-12
iee     10  4   dc 56.01E-6
hlim    90  0   vlim 1K
q1      11  2   13 qx
q2      12  1   14 qx
r2      6   9   100.0E3
rc1     3   11  530.5
rc2     3   12  530.5
rel     13  10  -393.2
re2     14  10  -393.2
ree     10  99  3.571E6
ro1     8   5   25
ro2     7   99  25
rp      3   4   8.013E3
vb      9   0   dc 0
vc      3   53  dc 2.400
ve      54  4   dc 2.100
vlim    7   8   dc 0
vlp     91  0   dc 40
vln     0   92  dc 40
.modeldx D(Is=800.0E-18)
.modelqx NPN(Is=800.0E-18 Bf=7.000E3)
.ends
```

Figure 45. Macromodel Subcircuit



POST OFFICE BOX 655303 • DALLAS, TEXAS 75265

APPLICATION INFORMATION

voltage-follower applications

The TLE2027 circuitry includes input-protection diodes to limit the voltage across the input transistors; however, no provision is made in the circuit to limit the current if these diodes are forward biased. This condition can occur when the device is operated in the voltage-follower configuration and driven with a fast, large-signal pulse. It is recommended that a feedback resistor be used to limit the current to a maximum of 1 mA to prevent degradation of the device. Also, this feedback resistor forms a pole with the input capacitance of the device. For feedback resistor values greater than 10 kΩ, this pole degrades the amplifier phase margin. This problem can be alleviated by adding a capacitor (20 pF to 50 pF) in parallel with the feedback resistor (see Figure 46).

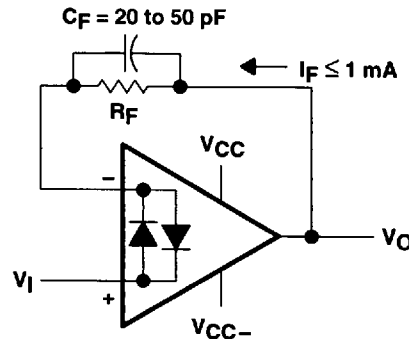

Figure 46. Voltage Follower

Input offset voltage nulling

The TLE2027 series offers external null terminals that can further reduce the input offset voltage. The circuits of Figure 47 can be connected as shown if the feature is desired. If external nulling is not needed, the null terminals may be left disconnected.



Figure 47. Input Offset-Voltage Nulling Circuits

TLE2027, TLE2027A, TLE2027Y
EXCALIBUR LOW-NOISE HIGH-SPEED
PRECISION OPERATIONAL AMPLIFIERS

SLOS054D – MAY 1990 – REVISED SEPTEMBER 1996

MECHANICAL INFORMATION

D (R-PDSO-G)**

PLASTIC SMALL-OUTLINE PACKAGE

14 PIN SHOWN

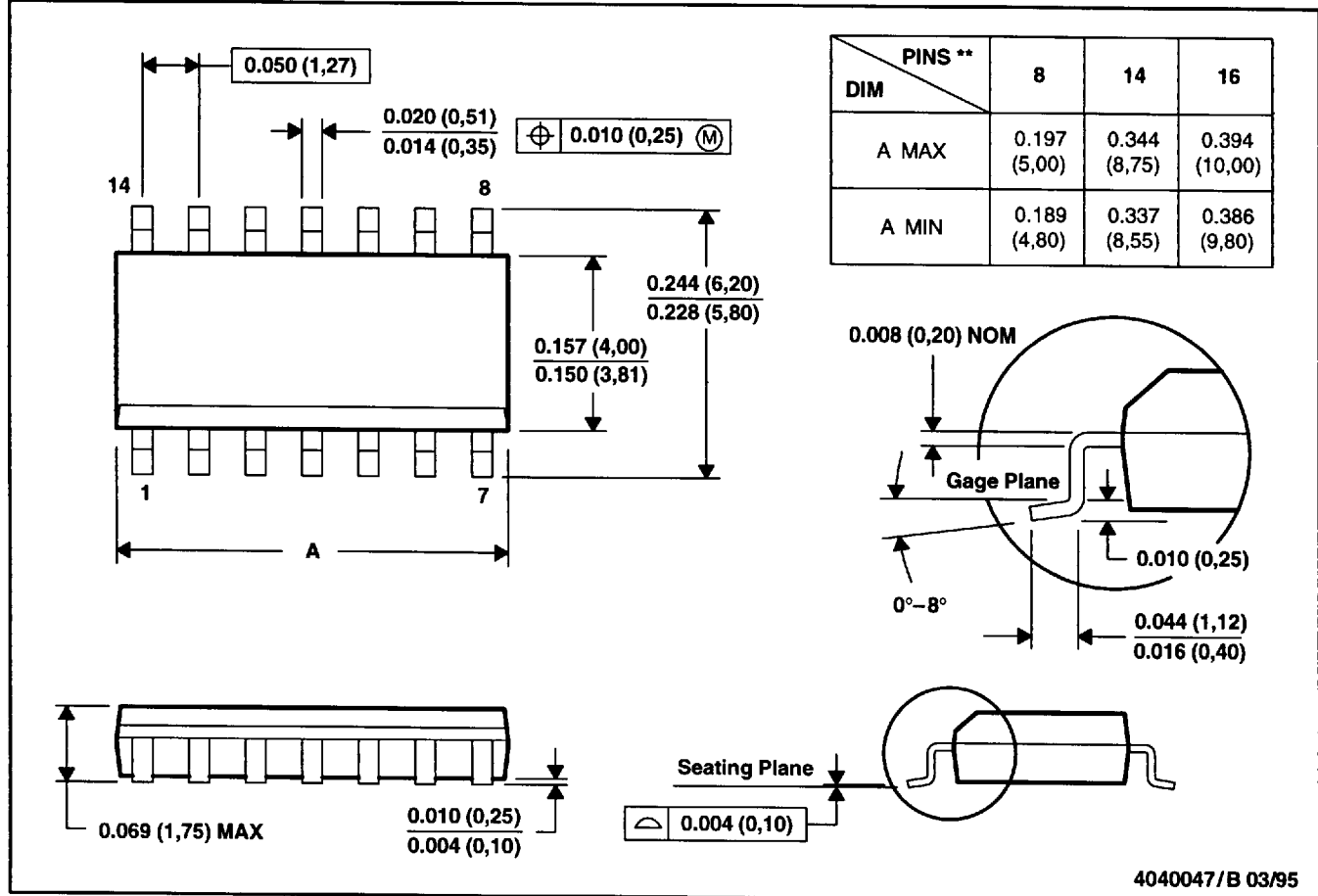

- NOTES: A. All linear dimensions are in inches (millimeters).
 B. This drawing is subject to change without notice.
 C. Body dimensions do not include mold flash or protrusion, not to exceed 0.006 (0,15).
 D. Four center pins are connected to die mount pad.
 E. Falls within JEDEC MS-012

TLE2027, TLE2027A, TLE2027Y
 EXCALIBUR LOW-NOISE HIGH-SPEED
 PRECISION OPERATIONAL AMPLIFIERS

SLOS054D - MAY 1990 - REVISED SEPTEMBER 1996

MECHANICAL INFORMATION

FK (S-CQCC-N**)

LEADLESS CERAMIC CHIP CARRIER

28 TERMINAL SHOWN

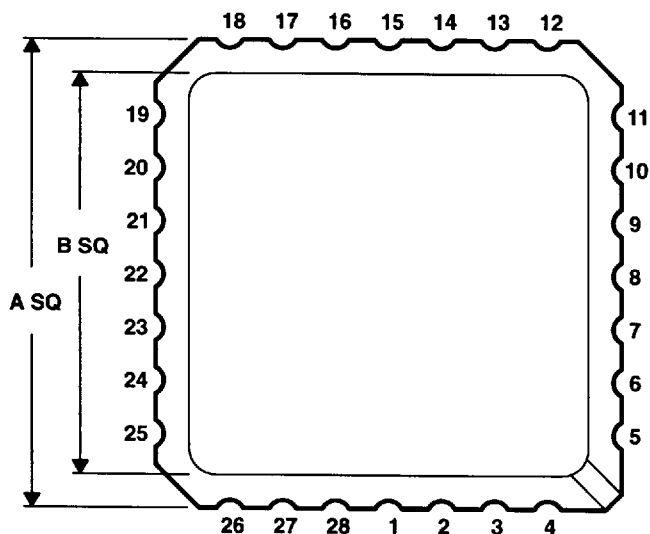

NO. OF TERMINALS **	A		B	
	MIN	MAX	MIN	MAX
20	0.342 (8,69)	0.358 (9,09)	0.307 (7,80)	0.358 (9,09)
28	0.442 (11,23)	0.458 (11,63)	0.406 (10,31)	0.458 (11,63)
44	0.640 (16,26)	0.660 (16,76)	0.495 (12,58)	0.560 (14,22)
52	0.740 (18,78)	0.761 (19,32)	0.495 (12,58)	0.560 (14,22)
68	0.938 (23,83)	0.962 (24,43)	0.850 (21,6)	0.858 (21,8)
84	1.141 (28,99)	1.165 (29,59)	1.047 (26,6)	1.063 (27,0)

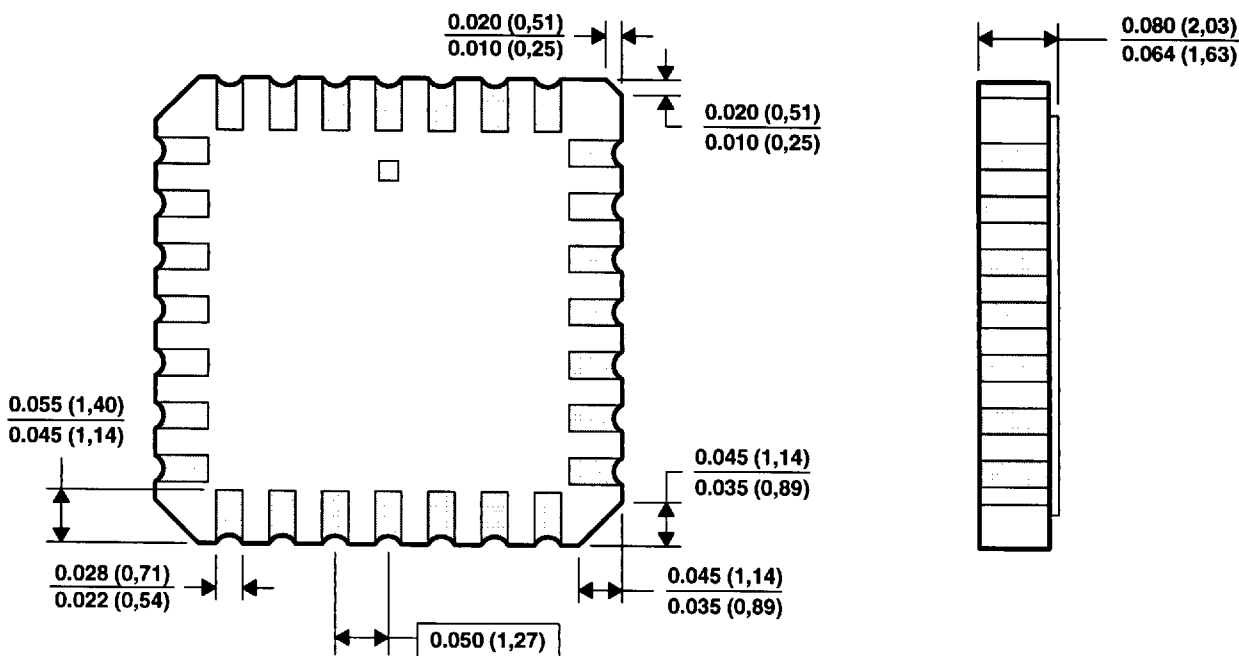

4040140/C 11/95

- NOTES: A. All linear dimensions are in inches (millimeters).
 B. This drawing is subject to change without notice.
 C. This package can be hermetically sealed with a metal lid.
 D. The terminals are gold plated.
 E. Falls within JEDEC MS-004



POST OFFICE BOX 655303 • DALLAS, TEXAS 75265

8961724 0103631 446

TLE2027, TLE2027A, TLE2027Y
EXCALIBUR LOW-NOISE HIGH-SPEED
PRECISION OPERATIONAL AMPLIFIERS

SLOS054D – MAY 1990 – REVISED SEPTEMBER 1996

MECHANICAL INFORMATION

JG (R-GDIP-T8)

CERAMIC DUAL-IN-LINE PACKAGE

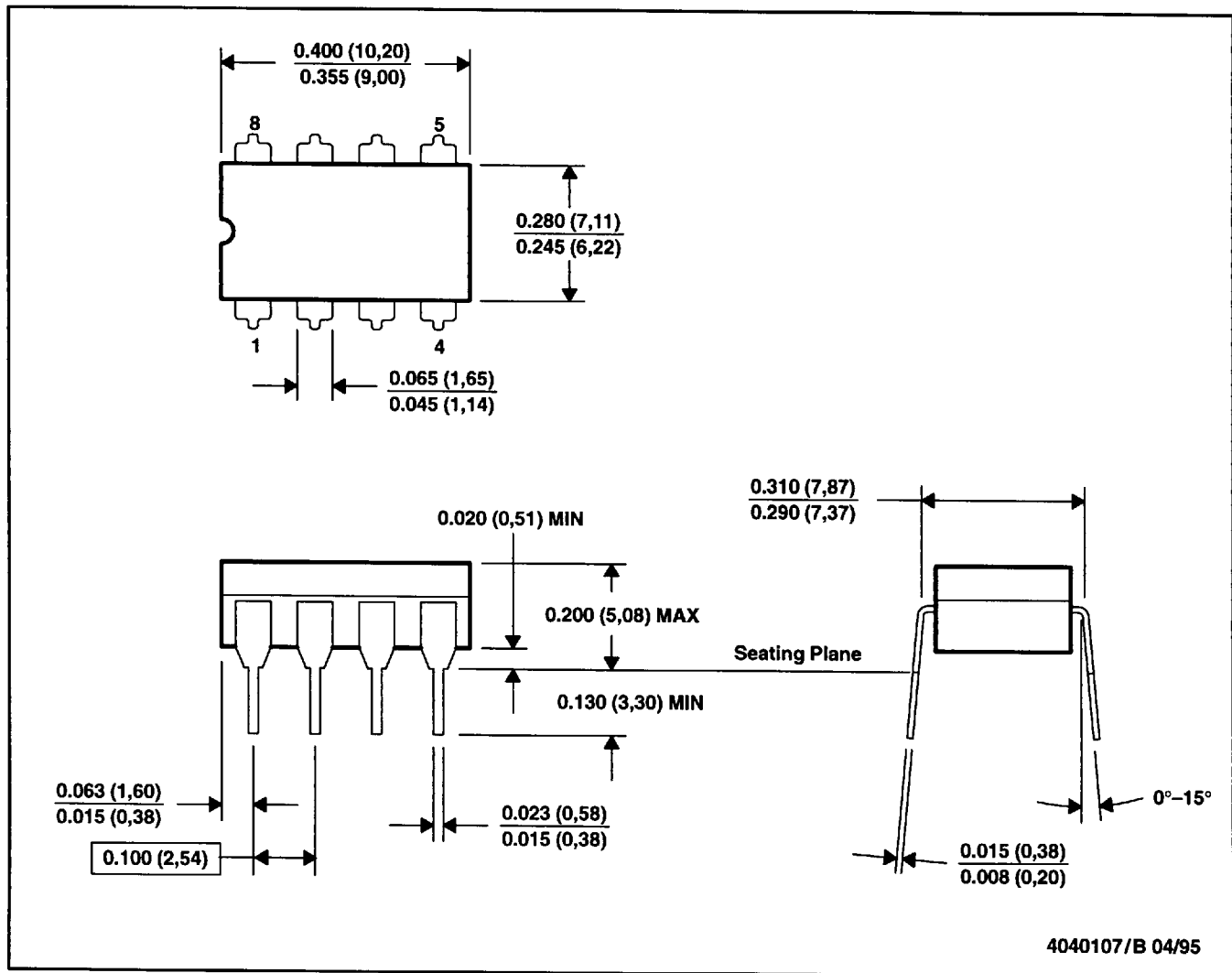

- NOTES: A. All linear dimensions are in inches (millimeters).
 B. This drawing is subject to change without notice.
 C. This package can be hermetically sealed with a ceramic lid using glass frit.
 D. Index point is provided on cap for terminal identification only on press ceramic glass frit seal only
 E. Falls within MIL-STD-1835 GDIP1-T8



POST OFFICE BOX 655303 • DALLAS, TEXAS 75265

TLE2027, TLE2027A, TLE2027Y
 EXCALIBUR LOW-NOISE HIGH-SPEED
 PRECISION OPERATIONAL AMPLIFIERS

SLOS054D - MAY 1990 - REVISED SEPTEMBER 1996

MECHANICAL INFORMATION

P (R-PDIP-T8)

PLASTIC DUAL-IN-LINE PACKAGE

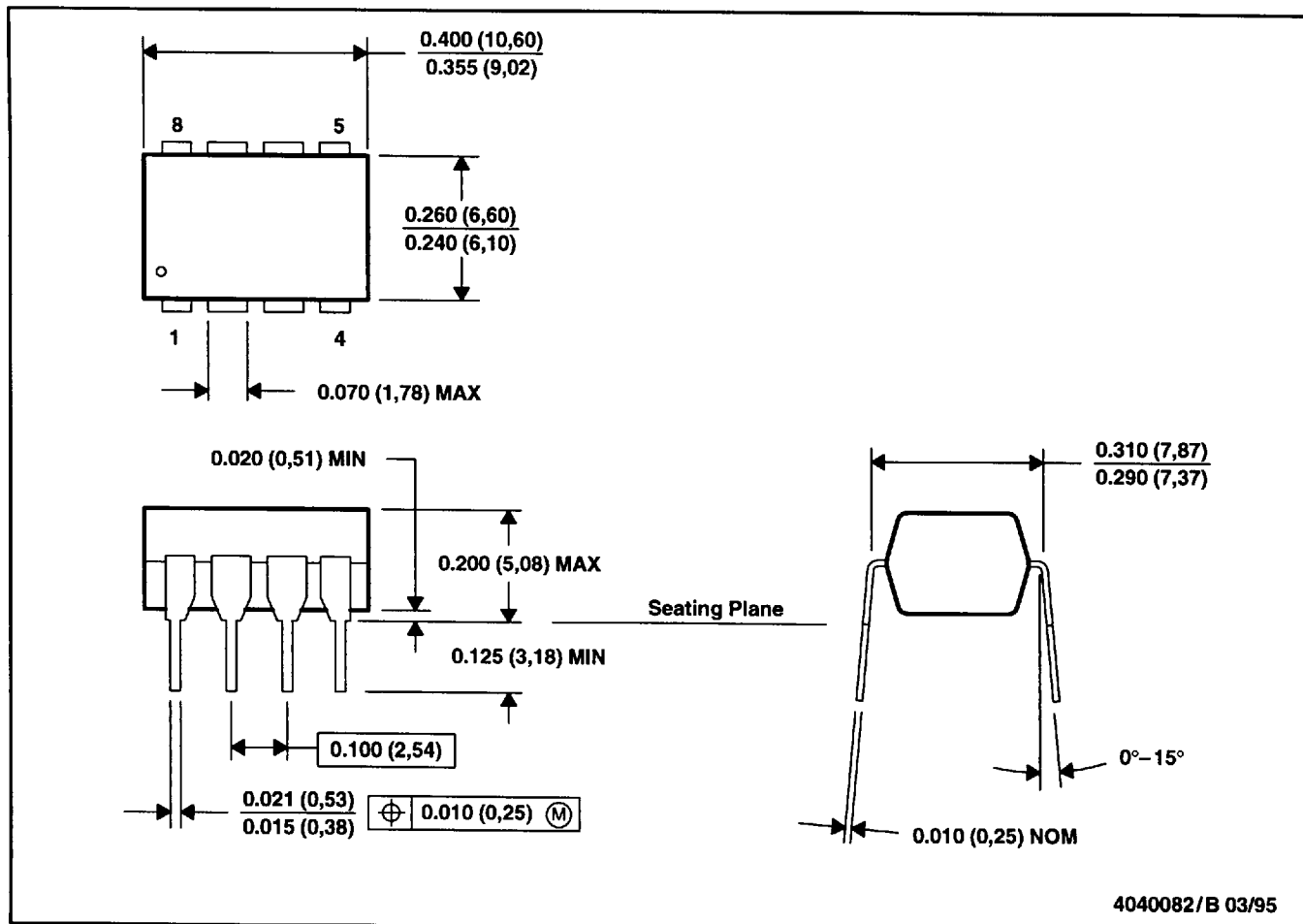

- NOTES: A. All linear dimensions are in inches (millimeters).
 B. This drawing is subject to change without notice.
 C. Falls within JEDEC MS-001



POST OFFICE BOX 655303 • DALLAS, TEXAS 75265