



Is Now Part of



ON Semiconductor®

To learn more about ON Semiconductor, please visit our website at
www.onsemi.com

Please note: As part of the Fairchild Semiconductor integration, some of the Fairchild orderable part numbers will need to change in order to meet ON Semiconductor's system requirements. Since the ON Semiconductor product management systems do not have the ability to manage part nomenclature that utilizes an underscore (_), the underscore (_) in the Fairchild part numbers will be changed to a dash (-). This document may contain device numbers with an underscore (_). Please check the ON Semiconductor website to verify the updated device numbers. The most current and up-to-date ordering information can be found at www.onsemi.com. Please email any questions regarding the system integration to Fairchild_questions@onsemi.com.

ON Semiconductor and the ON Semiconductor logo are trademarks of Semiconductor Components Industries, LLC dba ON Semiconductor or its subsidiaries in the United States and/or other countries. ON Semiconductor owns the rights to a number of patents, trademarks, copyrights, trade secrets, and other intellectual property. A listing of ON Semiconductor's product/patent coverage may be accessed at www.onsemi.com/site/pdf/Patent-Marking.pdf. ON Semiconductor reserves the right to make changes without further notice to any products herein. ON Semiconductor makes no warranty, representation or guarantee regarding the suitability of its products for any particular purpose, nor does ON Semiconductor assume any liability arising out of the application or use of any product or circuit, and specifically disclaims any and all liability, including without limitation special, consequential or incidental damages. Buyer is responsible for its products and applications using ON Semiconductor products, including compliance with all laws, regulations and safety requirements or standards, regardless of any support or applications information provided by ON Semiconductor. "Typical" parameters which may be provided in ON Semiconductor data sheets and/or specifications can and do vary in different applications and actual performance may vary over time. All operating parameters, including "Typicals" must be validated for each customer application by customer's technical experts. ON Semiconductor does not convey any license under its patent rights nor the rights of others. ON Semiconductor products are not designed, intended, or authorized for use as a critical component in life support systems or any FDA Class 3 medical devices or medical devices with a same or similar classification in a foreign jurisdiction or any devices intended for implantation in the human body. Should Buyer purchase or use ON Semiconductor products for any such unintended or unauthorized application, Buyer shall indemnify and hold ON Semiconductor and its officers, employees, subsidiaries, affiliates, and distributors harmless against all claims, costs, damages, and expenses, and reasonable attorney fees arising out of, directly or indirectly, any claim of personal injury or death associated with such unintended or unauthorized use, even if such claim alleges that ON Semiconductor was negligent regarding the design or manufacture of the part. ON Semiconductor is an Equal Opportunity/Affirmative Action Employer. This literature is subject to all applicable copyright laws and is not for resale in any manner.

GBU8A - GBU8M Bridge Rectifiers

Features

- Glass-Passivated Junction
- Surge Overload Rating: 200 A Peak
- Reliable Low-Cost Construction Utilizing Molded Plastic Technique
- Ideal for Printed Circuit Board
- UL Certified: UL #E258596



Ordering Informations

Part Number	Marking	Package	Packing Method
GBU8A	GBU8A	GBU 4L	Rail
GBU8B	GBU8B	GBU 4L	Rail
GBU8D	GBU8D	GBU 4L	Rail
GBU8G	GBU8G	GBU 4L	Rail
GBU8J	GBU8J	GBU 4L	Rail
GBU8K	GBU8K	GBU 4L	Rail
GBU8M	GBU8M	GBU 4L	Rail

Absolute Maximum Ratings

Stresses exceeding the absolute maximum ratings may damage the device. The device may not function or be operable above the recommended operating conditions and stressing the parts to these levels is not recommended. In addition, extended exposure to stresses above the recommended operating conditions may affect device reliability. The absolute maximum ratings are stress ratings only. Values are at $T_A = 25^\circ\text{C}$ unless otherwise noted.

Symbol	Parameter	Value							Units
		8A	8B	8D	8G	8J	8K	8M	
V_{RRM}	Maximum Repetitive Reverse Voltage	50	100	200	400	600	800	1000	V
V_{RMS}	Maximum RMS Bridge Input Voltage	35	70	140	280	420	560	700	V
V_R	DC Reverse Voltage (Rated V_R)	50	100	200	400	600	800	1000	V
$I_{F(AV)}$	Average Rectified Forward Current	$T_C = 100^\circ\text{C}$							A
		$T_A = 45^\circ\text{C}$							A
I_{FSM}	Non-Repetitive Peak Forward Surge Current 8.3 ms Single Half-Sine-Wave	200							A
T_{STG}	Storage Temperature Range	-55 to +150							$^\circ\text{C}$
T_J	Operating Junction Temperature	-55 to +150							$^\circ\text{C}$

Thermal Characteristics

Values are at $T_A = 25^\circ\text{C}$ unless otherwise noted.

Symbol	Parameter	Value	Units
P_D	Power Dissipation	16	W
$R_{\theta JA}$	Thermal Resistance per Leg, Junction to Ambient ⁽¹⁾	18	$^\circ\text{C}/\text{W}$
$R_{\theta JC}$	Thermal Resistance per Leg, Junction to Case ⁽²⁾	3	$^\circ\text{C}/\text{W}$

Notes:

1. Device mounted on PCB with 0.5×0.5 inch (12×12 mm).
2. Heat-sink mounting, $4 \times 4 \times 0.15$ inch copper plate.

Electrical Characteristics

Values are at $T_A = 25^\circ\text{C}$ unless otherwise noted.

Symbol	Parameter	Value	Units
V_F	Forward Voltage, per Element	8.0 A	1.0 V
I_R	Reverse Current, per Element at Rated V_R	$T_A = 25^\circ\text{C}$	5.0 μA
		$T_A = 100^\circ\text{C}$	500 μA
I^2t	I^2t Rating for Fusing	$t < 8.35$ ms	166 A^2s

Typical Performance Characteristics

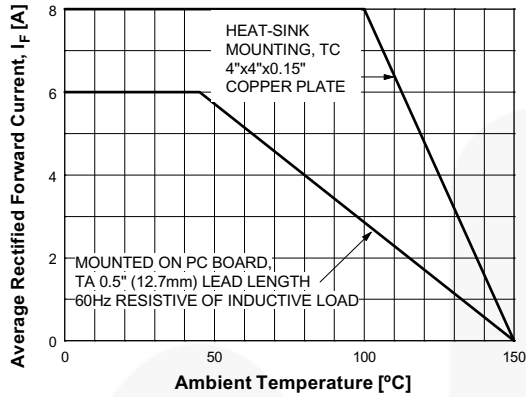

Figure 1. Forward Current Derating Curve

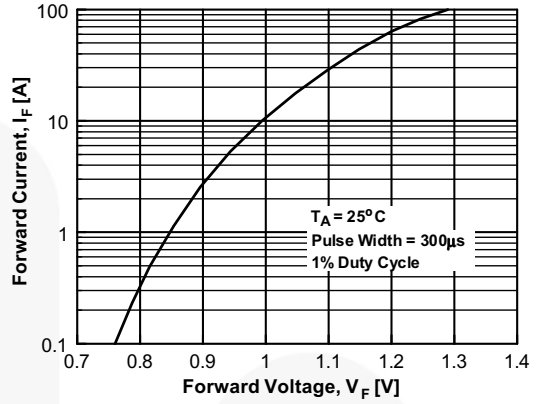

Figure 2. Forward Voltage Characteristics

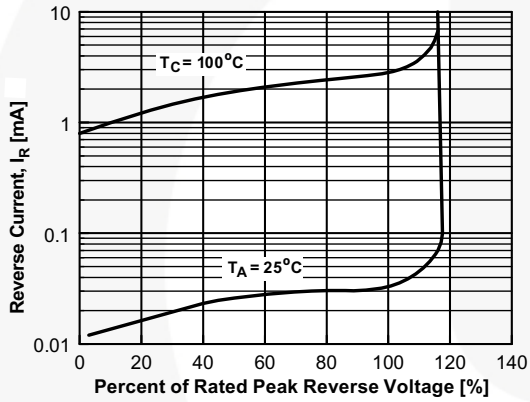

Figure 3. Reverse Current vs. Reverse Voltage

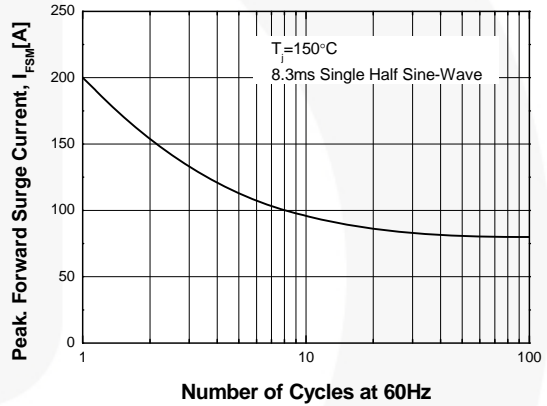

Figure 4. Non-Repetitive Surge Current

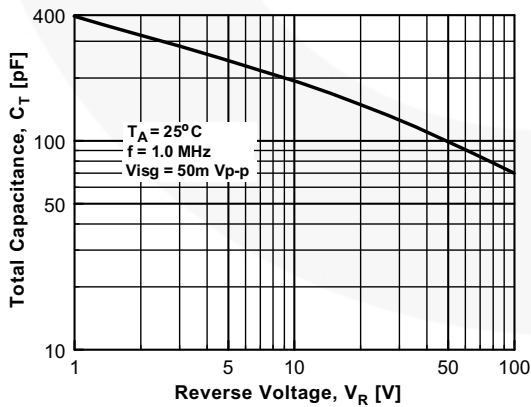
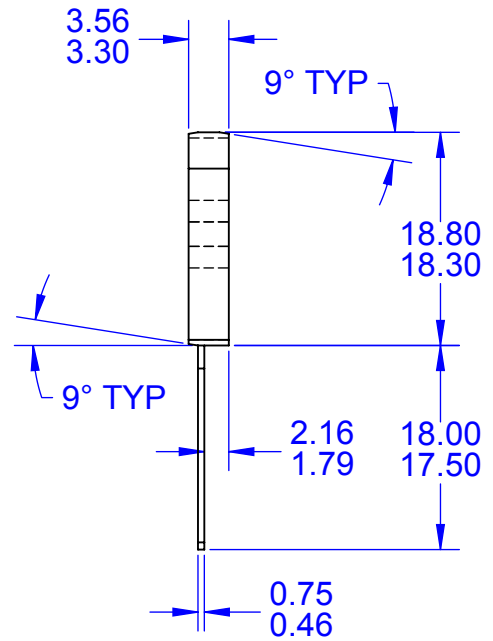

Figure 5. Total Capacitance



TOP VIEW



SIDE VIEW

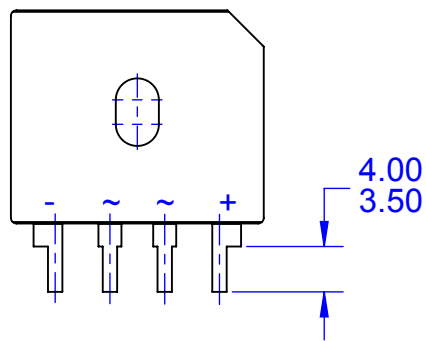

TOP VIEW - SHORT LEAD OPTION

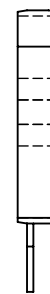

SIDE VIEW

NOTES:

- A. NO INDUSTRY STANDARD APPLIES TO THIS PACKAGE
- B. ALL DIMENSIONS ARE IN MILLIMETERS
- C. DIMENSIONS ARE EXCLUSIVE OF BURRS, MOLD FLASH AND TIE BAR PROTRUSIONS
- D. DIMENSIONS AND TOLERANCES AS PER ASME Y14.5-2009
- E. DRAWING FILENAME: MKT-GBU04Arev3



ON Semiconductor and  are trademarks of Semiconductor Components Industries, LLC dba ON Semiconductor or its subsidiaries in the United States and/or other countries. ON Semiconductor owns the rights to a number of patents, trademarks, copyrights, trade secrets, and other intellectual property. A listing of ON Semiconductor's product/patent coverage may be accessed at www.onsemi.com/site/pdf/Patent-Marking.pdf. ON Semiconductor reserves the right to make changes without further notice to any products herein. ON Semiconductor makes no warranty, representation or guarantee regarding the suitability of its products for any particular purpose, nor does ON Semiconductor assume any liability arising out of the application or use of any product or circuit, and specifically disclaims any and all liability, including without limitation special, consequential or incidental damages. Buyer is responsible for its products and applications using ON Semiconductor products, including compliance with all laws, regulations and safety requirements or standards, regardless of any support or applications information provided by ON Semiconductor. "Typical" parameters which may be provided in ON Semiconductor data sheets and/or specifications can and do vary in different applications and actual performance may vary over time. All operating parameters, including "Typicals" must be validated for each customer application by customer's technical experts. ON Semiconductor does not convey any license under its patent rights nor the rights of others. ON Semiconductor products are not designed, intended, or authorized for use as a critical component in life support systems or any FDA Class 3 medical devices or medical devices with a same or similar classification in a foreign jurisdiction or any devices intended for implantation in the human body. Should Buyer purchase or use ON Semiconductor products for any such unintended or unauthorized application, Buyer shall indemnify and hold ON Semiconductor and its officers, employees, subsidiaries, affiliates, and distributors harmless against all claims, costs, damages, and expenses, and reasonable attorney fees arising out of, directly or indirectly, any claim of personal injury or death associated with such unintended or unauthorized use, even if such claim alleges that ON Semiconductor was negligent regarding the design or manufacture of the part. ON Semiconductor is an Equal Opportunity/Affirmative Action Employer. This literature is subject to all applicable copyright laws and is not for resale in any manner.

PUBLICATION ORDERING INFORMATION

LITERATURE FULFILLMENT:

Literature Distribution Center for ON Semiconductor
19521 E. 32nd Pkwy, Aurora, Colorado 80011 USA
Phone: 303-675-2175 or 800-344-3860 Toll Free USA/Canada
Fax: 303-675-2176 or 800-344-3867 Toll Free USA/Canada
Email: orderlit@onsemi.com

N. American Technical Support: 800-282-9855 Toll Free
USA/Canada
Europe, Middle East and Africa Technical Support:
Phone: 421 33 790 2910
Japan Customer Focus Center
Phone: 81-3-5817-1050

ON Semiconductor Website: www.onsemi.com
Order Literature: <http://www.onsemi.com/orderlit>
For additional information, please contact your local
Sales Representative