



# LED Display Product Data Sheet LTS-5703AKF

Spec No.: DS30-2006-022

Effective Date: 02/23/2006

Revision: -

**LITE-ON DCC**

**RELEASE**

BNS-OD-FC001/A4

**FEATURES**

- \* 0.56 inch (14.22 mm ) DIGIT HEIGHT.
- \* CONTINUOUS UNIFORM SEGMENTS.
- \* LOW POWER REQUIREMENT.
- \* EXCELLENT CHARACTERS APPEARANCE.
- \* HIGH BRIGHTNESS & HIGH CONTRAST.
- \* WIDE VIEWING ANGLE.
- \* SOLID STATE RELIABILITY.
- \* CATEGORIZED FOR LUMINOUS INTENSITY.
- \* **LEAD-FREE PACKAGE (ACCORDING TO ROHS)**

**DESCRIPTION**

The LTS-5703AKF is a 0.56 inch (14.22 mm) height digit display. The device utilizes AS-AllnGaP Yellow Orange LED chips (AllnGaP epi on GaAs substrate), and have light gray face and white segments.

**DEVICE**

<b>PART NO.</b>	<b>DESCRIPTION</b>
AllnGaP Yellow Orange	Common Cathode
LTS-5703AKF	Rt. Hand Decimal

## PACKAGE DIMENSIONS

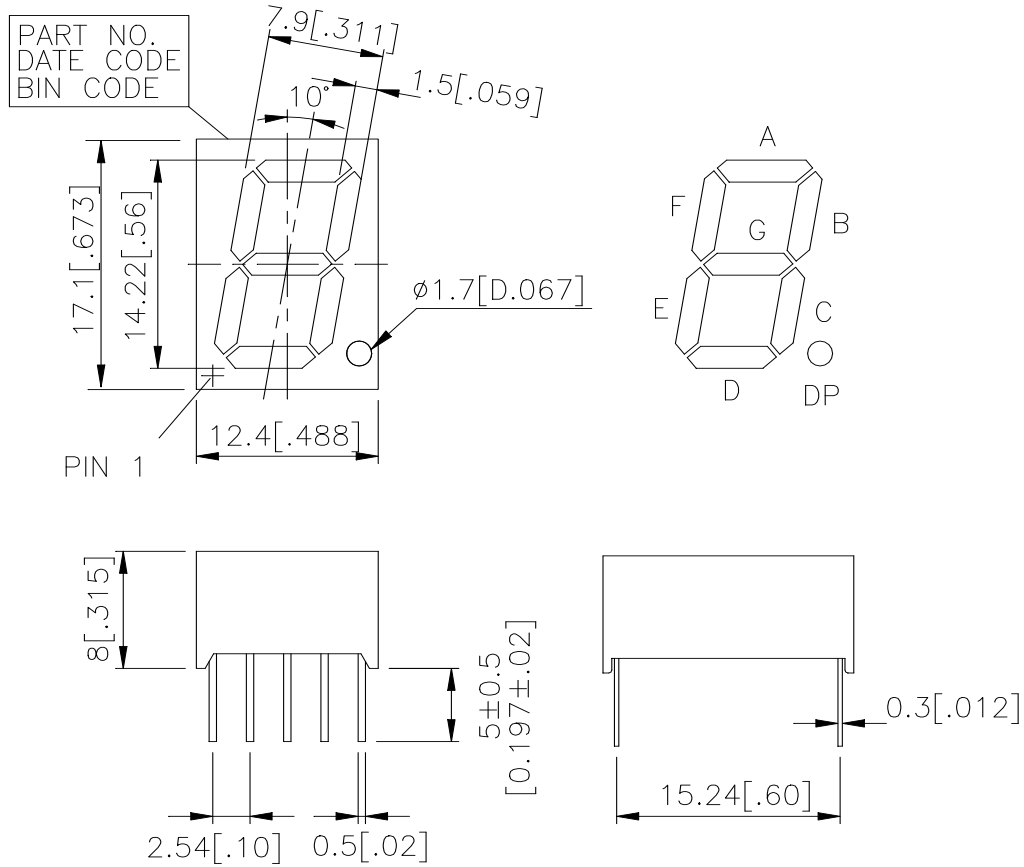

- NOTES: 1. All dimensions are in millimeters. Tolerances are  $\pm 0.25$ -mm (0.01") unless otherwise noted.  
 2. Pin tip's shift tolerance is  $\pm 0.4$  mm.

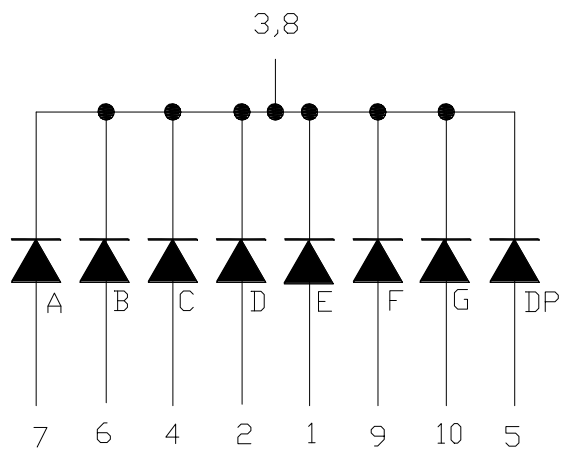
**INTERNAL CIRCUIT DIAGRAM**

**PIN CONNECTION**

<b>No.</b>	<b>CONNECTION</b>
1	ANODE E
2	ANODE D
3	COMMON CATHODE
4	ANODE C
5	ANODE D.P.
6	ANODE B
7	ANODE A
8	COMMON CATHODE
9	ANODE F
10	ANODE G

**ABSOLUTE MAXIMUM RATING AT Ta=25°C**

PARAMETER	MAXIMUM RATING	UNIT
Power Dissipation Per Segment	70	mW
Peak Forward Current Per Segment ( 1/10 Duty Cycle, 0.1ms Pulse Width )	60	mA
Continuous Forward Current Per Segment	25	mA
Derating Linear From 25°C Per Segment	0.33	mA/°C
Reverse Voltage Per Segment	5	V
Operating Temperature Range	-35°C to +85°C	
Storage Temperature Range	-35°C to +85°C	
Solder Temperature 1/16 inch Below Seating Plane for 3 Seconds at 260°C or temperature of unit (during assembly) not over max. temperature rating above		

**ELECTRICAL / OPTICAL CHARACTERISTICS AT Ta=25°C**

PARAMETER	SYMBOL	MIN.	TYP.	MAX.	UNIT	TEST CONDITION
Average Luminous Intensity	I <sub>v</sub>	800	1667		μcd	I <sub>F</sub> =1mA
Peak Emission Wavelength	λ <sub>p</sub>		611		nm	I <sub>F</sub> =20mA
Spectral Line Half-Width	Δλ		17		nm	I <sub>F</sub> =20mA
Dominant Wavelength	λ <sub>d</sub>		605		nm	I <sub>F</sub> =20mA
Forward Voltage Per Segment	V <sub>F</sub>		2.05	2.6	V	I <sub>F</sub> =20mA
Reverse Current Per Segment	I <sub>R</sub>			100	μA	V <sub>R</sub> =5V
Luminous Intensity Matching Ratio (Similar Light Area)	I <sub>v-m</sub>			2:1		I <sub>F</sub> =1mA

Note: Luminous intensity is measured with a light sensor and filter combination that approximates the CIE (Commision Internationale De L'Eclariage) eye-response curve.

## TYPICAL ELECTRICAL / OPTICAL CHARACTERISTIC CURVES

(25°C Ambient Temperature Unless Otherwise Noted)

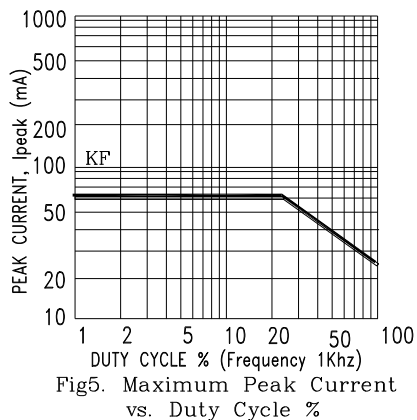
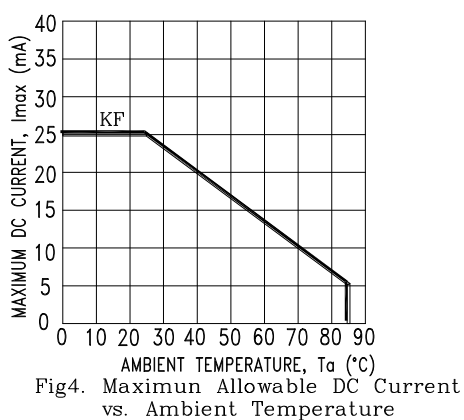
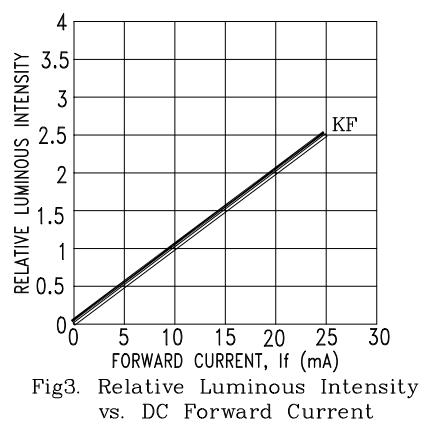
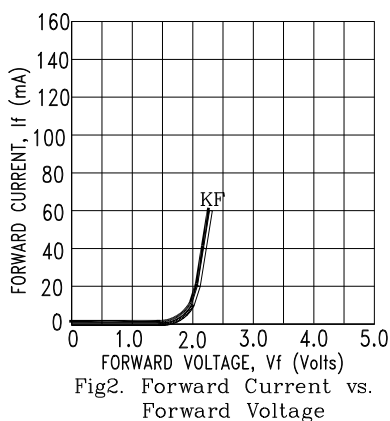
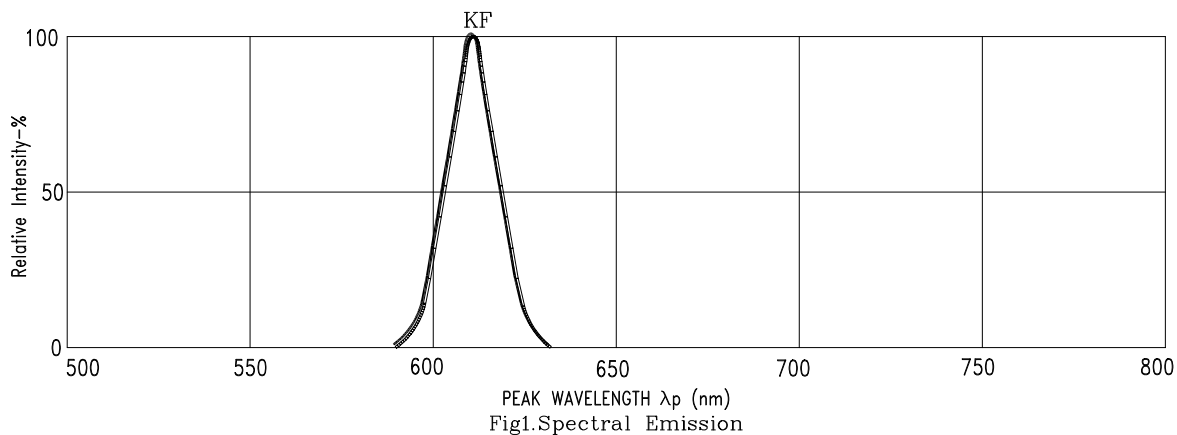

NOTE : KF=AlInGaP YELLOW ORANGE