

XST-3535-UV

Surface Mount

UVC LED

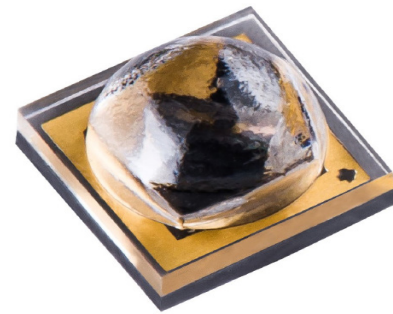

Table of Contents

Ordering Information	2
Binning Structure	3
Typical Device Performance	4
Absolute Maximum Ratings	4
Optical and Electrical Characteristics	5
Typical Spectrum & Radiation Pattern	6
Mechanical Dimensions	7
Solder Profile	8
Shipping Reel Outline	9
Shipping Label	10
Precautions for Use	11
History of Changes	12

Features:

- UVC LED with emission wavelength between 270 nm and 285 nm
- High Optical Power: 100 mW+ of UVC power at maximum rated current
- Compact form factor: 3.5 mm x 3.5 mm package
- Narrow viewing angle of 60 degrees
- Standard SMT Process
- RoHS and REACH compliant

Applications

- Air Purification
- Water Purification
- Surface Disinfection
- Medical Device Sterilization
- Appliance Sterilization
- Food & Beverage Preparation

Ordering Information

Ordering Part Numbers

The table below lists ordering part numbers available for XST-3535-UV LEDs. The part number includes a bin kit, a group of flux and wavelength bins described in page 3, that are shippable for a given ordering part number. Individual flux bins are not orderable. Flux bin listed is minimum bin shipped - higher bins may be included at Luminus' discretion.

Wavelength		Radiometric Flux		Ordering Part Number
Range (nm)	Bin kit	Bin Kit Flux Code	Min. Flux (mW)	
270-280	270, 275	CD	35	XST-3535-UV-A60-CD270-00
275-280	275	CD	35	XST-3535-UV-A60-CD275-01
280-285	280	CD	35	XST-3535-UV-A60-CD280-01
275-285	275, 280	CD	35	XST-3535-UV-A60-CD275-00
270-280	270, 275	CE	40	XST-3535-UV-A60-CE270-00
275-280	275	CE	40	XST-3535-UV-A60-CE275-01
280-285	280	CE	40	XST-3535-UV-A60-CE280-01
275-285	275, 280	CE	40	XST-3535-UV-A60-CE275-00

Part Number Nomenclature

XST — **3535** — **<UV>** — **<A##>** — **<FF###>**

Product Family	Package Type	Color	Package Configuration	Bin kit
XST: UVC Surface Mount Package	3535: 3.5 mm x 3.5 mm	Ultraviolet	A60: 60 degree lens	Flux and Wavelength bin kit code - See ordering informaton

XST-3535-UV Binning Structure

XST-3535-UV LEDs are tested at a drive current of 350 mA, 20 ms single pulse at 25 °C and placed into one of the following radiometric flux (FF), wavelength (WWW) and forward voltage bins.

Radiometric Flux Bins¹

The LEDs can also be driven at higher drive currents, to achieve the correlated flux values listed in the table.

Flux Bin	Binning @ 350 mA, 25 °C		Correlated Minimum Flux (mW) @ 25 °C		
	Mini Flux (mW)	Max Flux (mW)	500 mA	650 mA	800 mA
CD	35	40	49	64	79
CE	40	45	56	74	90
CF	45	50	63	83	101
CG	50	55	70	92	113
CH	55	60	77	101	124
DA	60	70	84	110	135

Wavelength Bins^{2,3}

Wavelength Bin	Binning @ 350 mA, 25 °C	
	Minimum Wavelength (nm)	Maximum Wavelength (nm)
270	270	275
275	275	280
280	280	285

Forward Voltage Bins

Voltage Bin	Binning @ 350 mA, 25 °C	
	Minimum Forward Voltage (V)	Maximum Forward Voltage (V)
V3	5.0	5.5
V4	5.5	6.0
V5	6.0	6.5
V6	6.5	7.0
V7	7.0	7.5

Note 1: Product lifetime is a function of drive current. Sustained operation at absolute maximum current of 800 mA will result in a reduction of device lifetime compared to typical forward drive currents (350 mA-500 mA). Actual device lifetimes will also depend on junction temperature. Contact Luminus for information on product lifetime.

Note 2: Luminus maintains a +/- 6% tolerance on flux measurements and +/- 1 nm on wavelength measurements.

Note 3: Individual flux bins are not orderable. Please refer to product ordering information on page 2 for a list of ordering part numbers.

Typical Device Performance^{1,2}

Parameter	Symbol	Value	Unit
Minimum Forward Voltage	V_{f-min}	5.0	V
Typical Forward Voltage	V_{f-typ}	6.45	V
Maximum Forward Voltage	V_{f-max}	7.5	V
FWHM	$\Delta\lambda$	10	nm
Viewing Angle	$2\theta_{1/2}$	60	°
Thermal Resistance (junction-solder point)	R_{th}	5.0	°C/W

Absolute Maximum Ratings²

Parameter	Symbol	Value	Unit
Forward Current	I_{f-max}	800	mA
Junction Temperature	T_j	100	°C

Note 1: Ratings are based on operation at a constant temperature of $T_j = 25$ °C. Test conditions: 350 mA, 20 ms pulse at 25 °C.

Note 2: XST-3535-UV LEDs are short wavelength, deep UV LEDs. During operation, the LED emits high intensity UVC radiation, which is harmful to skin and eyes. UV light is also hazardous to skin and may cause cancer. Avoid exposure to deep UV light when LED is operational.

Optical & Electrical Characteristics

Relative Power vs. Forward Current

$\phi/\phi_{(350\text{ mA})}$, 20 ms pulse, $T_j = 25^\circ\text{C}$

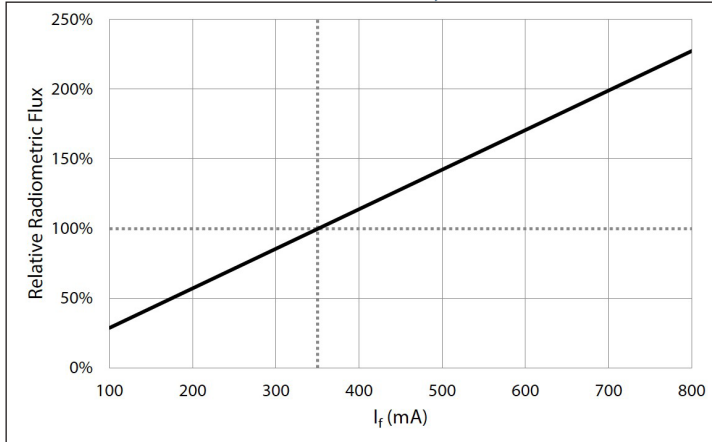

Relative Power vs. Junction Temperature

$\phi/\phi_{(25^\circ\text{C})}$, 20 ms pulse, 350 mA

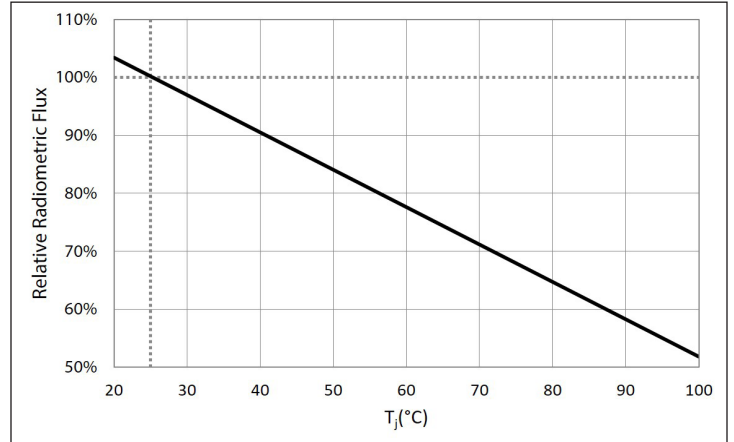

Peak Wavelength Shift vs. Forward Current

$\lambda_p = \lambda_p(I_f) - \lambda_p(350\text{ mA})$, 20 ms pulse, $T_j = 25^\circ\text{C}$

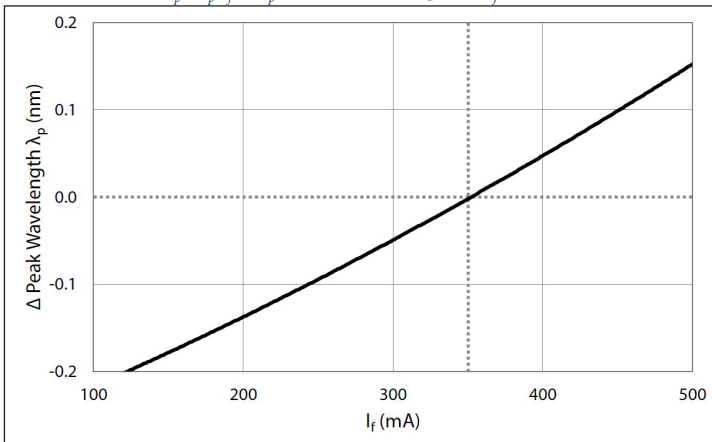

Peak Wavelength Shift vs. Junction Temperature

$\lambda_p = \lambda_p(T_j) - \lambda_p(25^\circ\text{C})$, 20 ms pulse, $I_f = 350\text{ mA}$

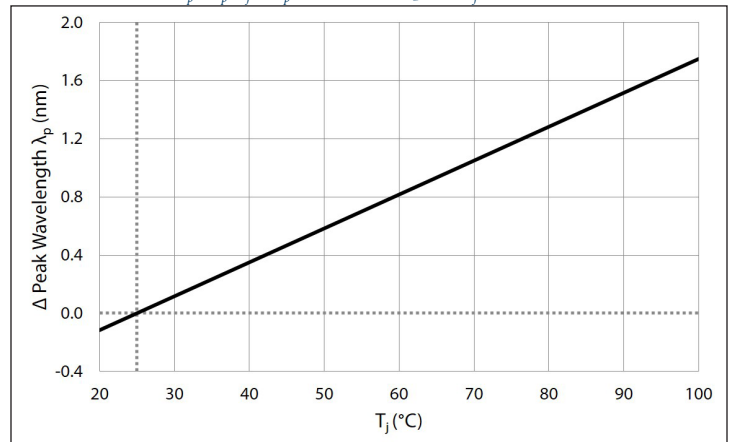

Forward Voltage vs Forward Current

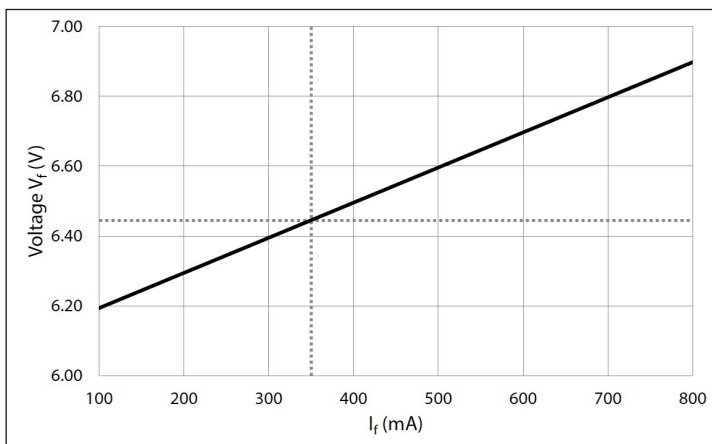

Forward Voltage Shift vs. Junction Temperature

$\Delta V_f = V_f(T_j) - V_f(25^\circ\text{C})$, 20 ms pulse, $I_f = 350\text{ mA}$

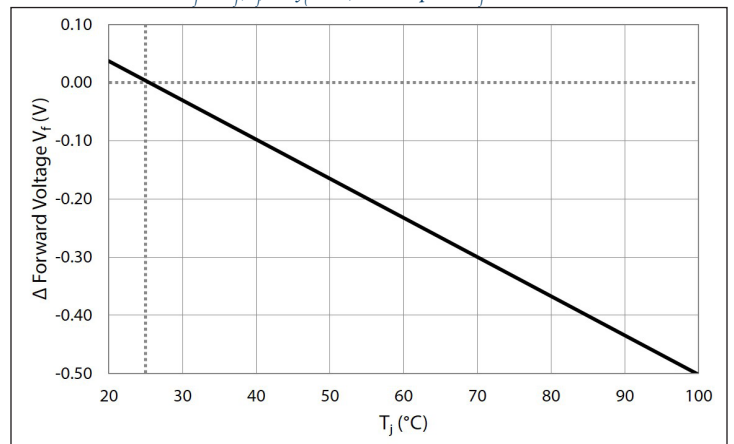

Typical Spectrum

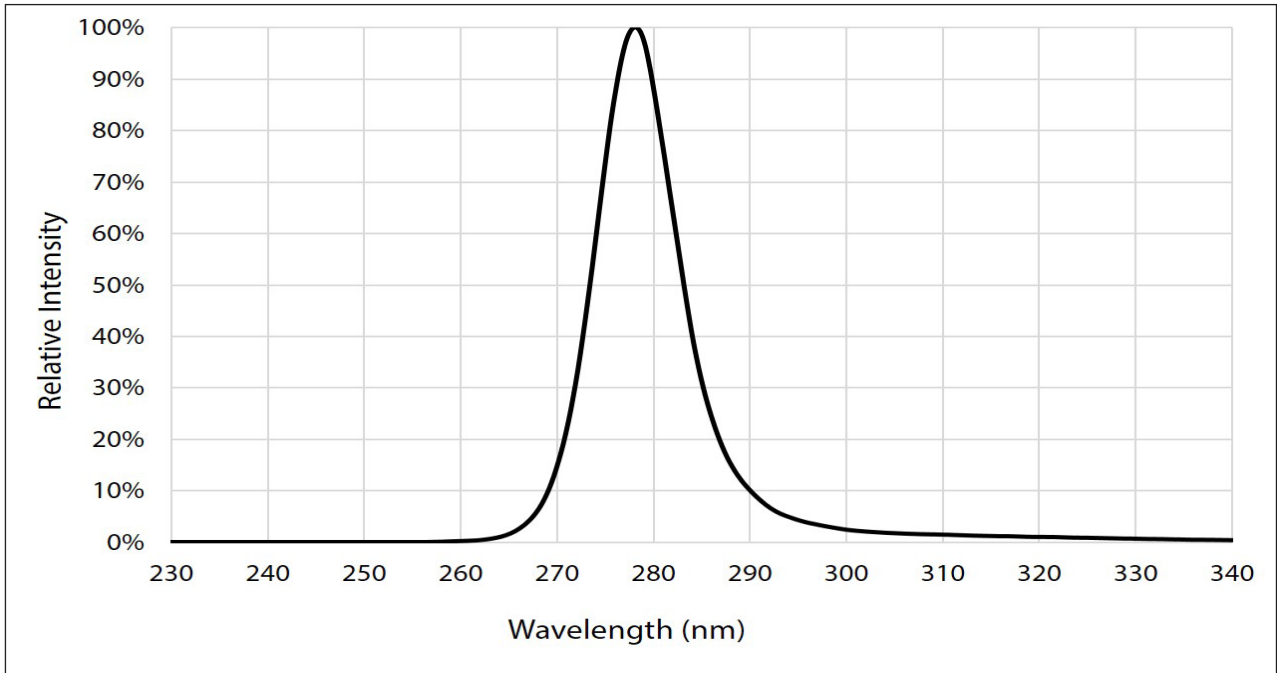

Radiation Pattern

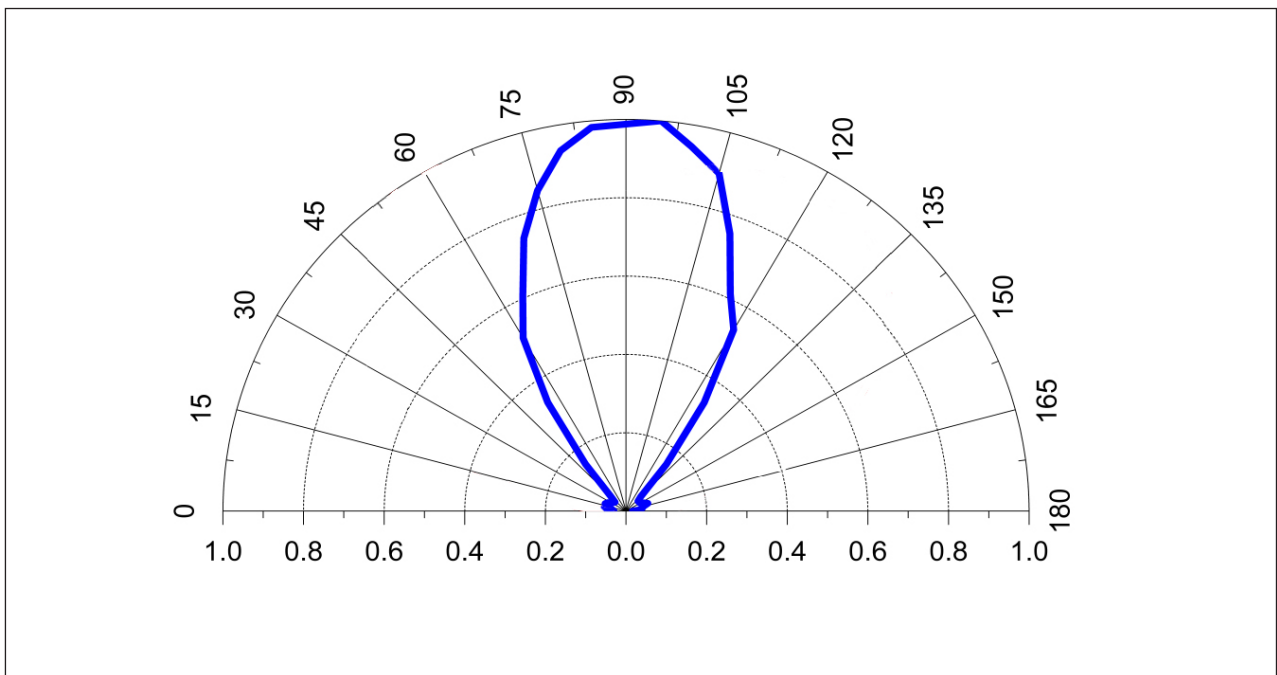

Mechanical Dimensions

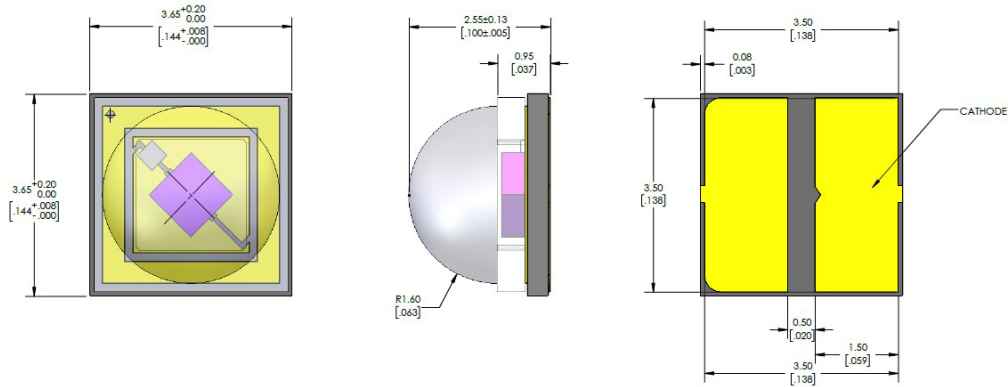

Recommended Solder Pad and Stencil Pattern

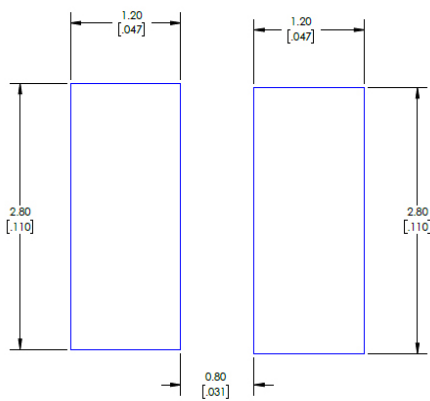

Recommended Stencil Pattern

Solder Pad	3.6 mm x 1.6 mm
Stencil Pattern	2.8 mm x 1.2 mm

Solder Profile

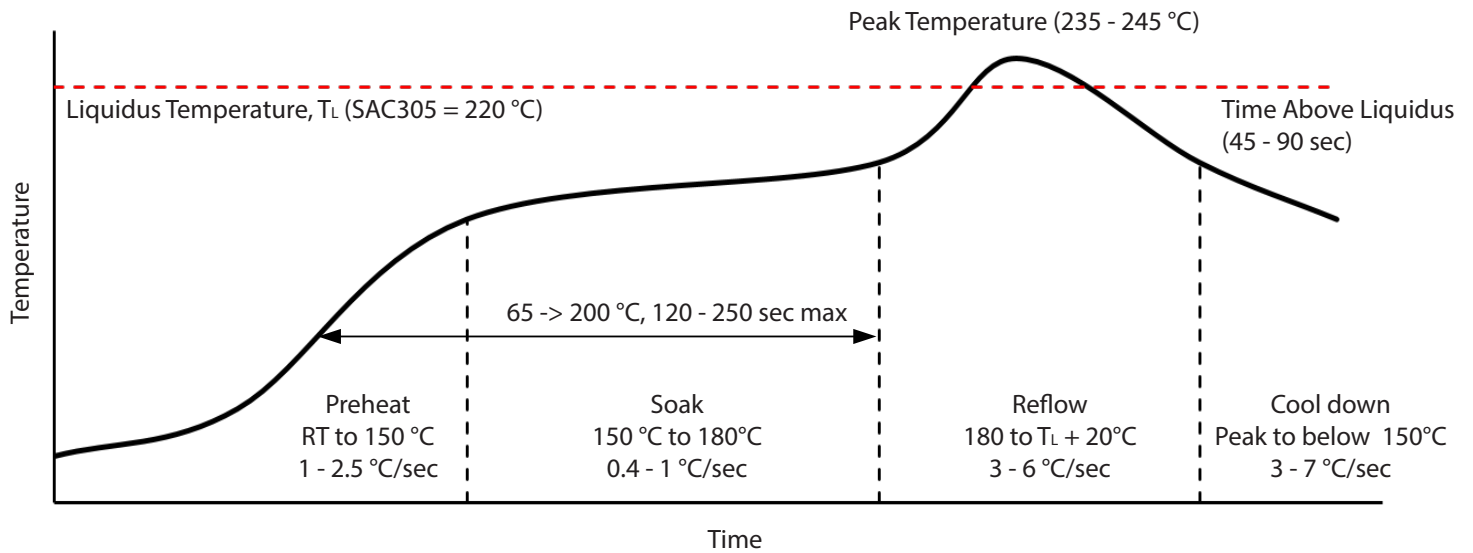

SMT Rework Guideline	Manual Hotplate Reflow	Hot Air Gun Reflow
Heating Time	< 60 sec	
Hotplate Temperature	< 245°C	< 150°C

Note 1: Product complies to Moisture Sensitivity Level 1 (MSL 1)

Note 2: The numbers in the table are specific to SAC305. Luminus recommends using an SAC305 solder paste with a no-clean flux for RoHS compliant products.

Note 3: During the pick and place process, axial forces on the dome (or window) should not exceed 0.5 Newtons (N)

Note 4: Use of a multi-zone IR reflow oven with a nitrogen blanket is recommended.

Note 5: Time-temperature profile of the reflow process showing the four functional profile zones are defined in IPC-7801. Temperature is referenced to the center of the PCB.

Note 6: Luminus recommends to use the solder paste data sheet information as a starting point in time-temperature process development.

Note 7: These are general guidelines. Consult the solder paste manufacturer's datasheet for guidelines specific to the alloy and flux combination used in your application. For more information, please refer to: <https://luminusdevices.zendesk.com/hc/en-us/articles/360060306692-How-do-I-Reflow-Solder-Luminus-SMD-Components->

Note 8: For any technical questions about soldering process, please contact Luminus at techsupport@luminus.com.

Product Shipping & Labeling Information

All XST-3535 products are packaged and labeled with their respective bin as outlined in the tables on pages 2 & 3. Each reel will only contain one flux and one wavelength bin

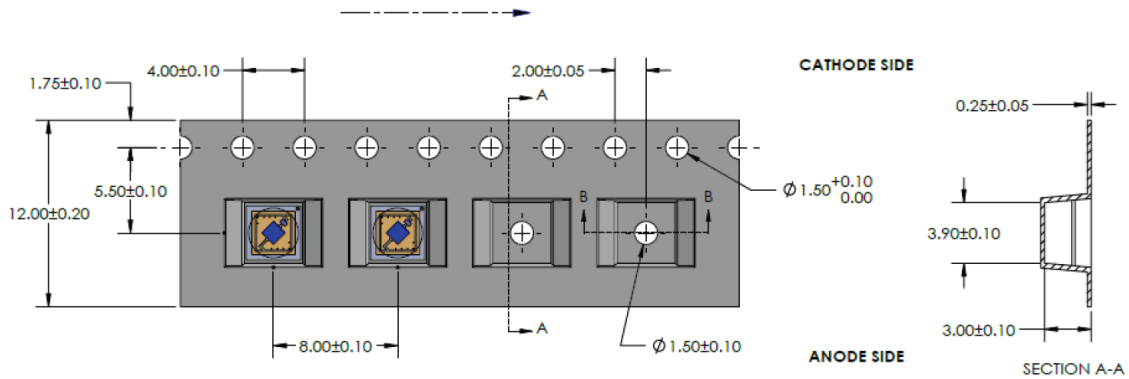

NOTES:

1. FINAL TAPE AND REEL PACKAGING MUST MEET THE REQUIREMENTS OF JEDEC-STD-033, LEVEL 2A.
2. LEADER LENGTH 150 EMPTY POCKETS (MINIMUM).
3. TRAILER LENGTH 110 EMPTY POCKETS (MINIMUM).
4. MUST COMPLY TO EIA-481-C-2003.

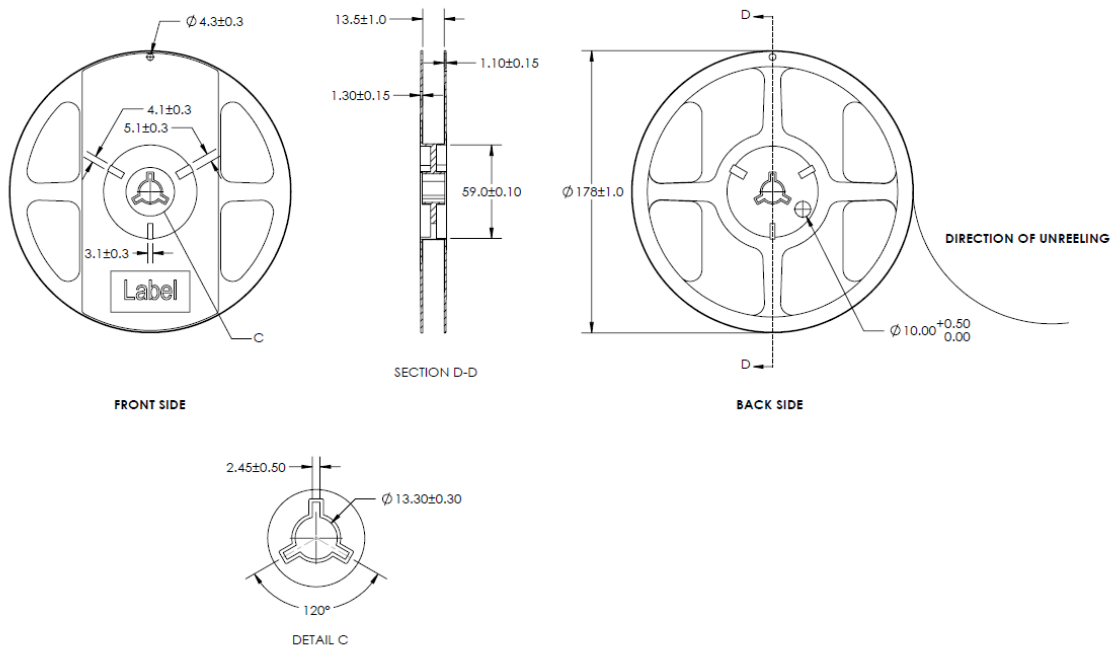

Shipping Label

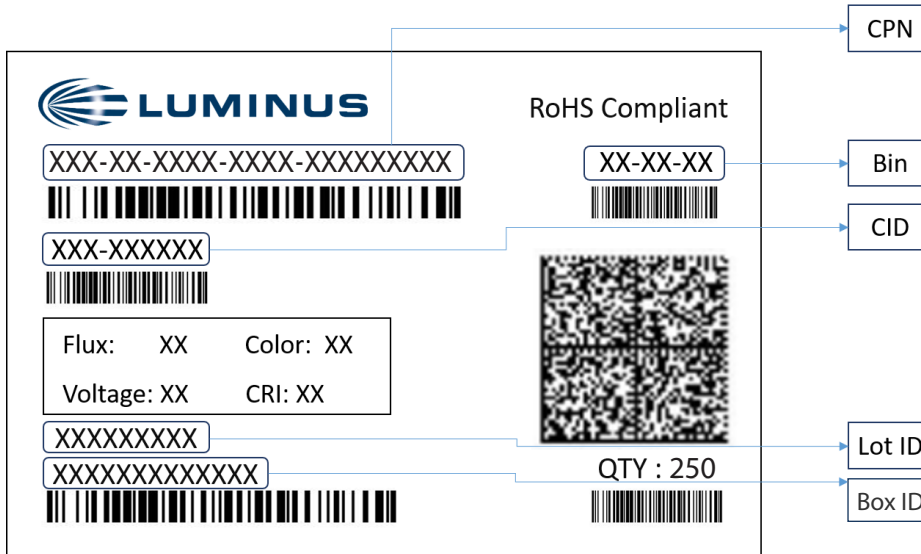

Label Fields:

- CPN: Luminus ordering part number
- CID: Customer's part number
- QTY: Quantity of devices in pack
- Flux: Bin as defined on page 3
- Voltage: Bin as defined on page 3
- Color: Bin as defined on page 3
- CRI: NA

Packing Configuration:

- Maximum of 250 devices per reel, minimum of 50 devices per reel.
- Partial pack or reel may be shipped
- Each pack is enclosed in anti-static bag
- Shipping label is placed on top of each pack

Precautions for storage, handling and use of UV LEDs

1. UV Light

XST-3535-UV LEDs are short wavelength, deep UV LEDs. During operation, the LED emits high intensity UVC radiation, which is harmful to skin and eyes. UV light is also hazardous to skin and may cause cancer. Avoid exposure to deep UV light when LED is operational.

Precautions must be taken to avoid looking directly at the UV light without the use of UV light protective glasses. Do not look directly at the front or at the LED's lens when LED is operational.

2. Static Electricity (ESD)

While XBT 3535 LEDs have built-in Zener protection diodes, they are particularly sensitive to ESD (Electrostatic Discharge). Static electricity and surge voltages seriously damage UV LEDs and can result in complete failure of the device. Precautions must be taken against ESD when handling or operating these devices.

Reference: APN-002815 Electrical Stress Damage to LEDs and How to Prevent It

3. Operating Conditions

In order to ensure the correct functioning of these LEDs, compliance to maximum allowed specifications is important. UV LEDs are particularly sensitive to drive currents that exceed the max operating specifications and may be damaged by such drive currents. The use of current regulated drive circuits is strongly recommended when operating these devices. Customers should also provide adequate thermal management to ensure LEDs do not exceed maximum recommended temperatures. Operating LEDs at temperatures in excess of specification will result in damage and possibly complete failure of the device.

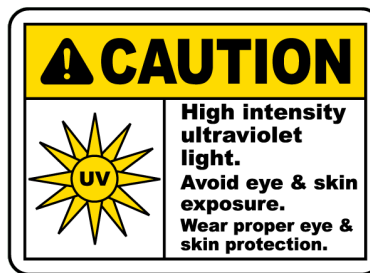

Revision History

Rev	Date	Description of Change
01	06/11/2019	Initial release
02	11/04/2019	Tape and Reel drawing
03	04/04/2020	Additional ordering part numbers introduced, increased max current rating
03	05/19/2020	Editorial change- spectrum reflects 275 nm Bins
04	06/17/2020	Defined higher bin (CH: 55-60 mW)
05	11/09/2020	New wavelength bins and Vf bins introduced. Updated drawing
06	09/08/2022	Add new flux bin, update solder profile, shipping label and editorial changes.
07	10/17/2022	Add new flux bin