



MAX9611 Evaluation Kit

General Description

The MAX9611 evaluation kit (EV kit) is an assembled and tested PCB used to evaluate the MAX9611 high-side current-sense amplifier with an integrated 12-bit ADC and a gain block that can be configured either as an op amp or as a comparator. The on-board microcontroller, which is connected to the PC through the universal serial bus (USB) port, acts as the I²C master.

The EV kit also includes Windows XP®, Windows Vista®, and Windows® 7-compatible software, which provides a simple user interface for exercising the device's features. The program is menu driven and offers a graphical user interface (GUI) complete with control buttons and status displays.

The EV kit comes with the MAX9611AUB+ installed (noninverting configuration). Contact the factory for free samples of the pin-compatible MAX9612AUB+ (inverting configuration).

Features

- ◆ 60V Current Sense with Integrated ADC
- ◆ Windows XP-, Windows Vista-, and Windows 7-Compatible Software
- ◆ On-Board Microcontroller to Generate I²C Commands
- ◆ Easy-to-Use, Menu-Driven Software
- ◆ USB-PC Connection (Cable Included)

Ordering Information

PART	TYPE
MAX9611EVKIT+	EV Kit

+Denotes lead(Pb)-free and RoHS compliant.

Component List

DESIGNATION	QTY	DESCRIPTION
C1, C12, C14, C20	4	10μF ±10%, 16V X5R ceramic capacitors (0805) Murata GRM21BR61C106K
C2, C3	2	22pF ±5%, 50V C0G ceramic capacitors (0603) Murata GRM1885C1H220J
C4	1	0.033μF ±10%, 25V X7R ceramic capacitor (0603) TDK C1608X7R1E333K
C5–C10, C17, C18, C23	9	0.1μF ±10%, 16V X7R ceramic capacitors (0603) TDK C1608X7R1C104K
C11, C13, C21, C22, C24, C25, C29, C30	8	1μF ±10%, 16V X5R ceramic capacitors (0603) TDK C1608X5R1C105K
C15, C16	2	10pF ±5%, 50V C0G ceramic capacitors (0603) Murata GRM1885C1H100J
C19, C28	0	Not installed, ceramic capacitors (0805)

DESIGNATION	QTY	DESCRIPTION
C26	1	1μF ±10%, 100V X7R ceramic capacitor (1206) Murata GRM31CR72A105KA01L
C27	1	10000pF ±10%, 100V X7R ceramic capacitor (0603) TDK C1608X7R2A103K
H1	0	Not installed, 10-pin (2 x 5) header
JU1, JU2, JU3	3	3-pin headers
JU4, JU5	2	5-pin headers
L1	1	Ferrite bead (0603) TDK MMZ1608R301A
M1	1	1.49A, 30V p-channel MOSFET (3 SOT23) Vishay Si2303BDS-T1-E3
P1	1	USB type-B right-angle PC-mount receptacle
OUT, RS+, RS-, SET	4	Test points, red
R1, R2	2	27Ω ±5% resistors (0603)
R3, R14, R15	3	1.5kΩ ±5% resistors (0603)

Windows, Windows XP, and Windows Vista are registered trademarks of Microsoft Corp.



MAX9611 Evaluation Kit

Component List (continued)

DESIGNATION	QTY	DESCRIPTION
R4	1	470Ω ±5% resistor (0603)
R5	1	2.2kΩ ±5% resistor (0603)
R6	1	10kΩ ±5% resistor (0603)
R7	1	169kΩ ±1% resistor (0603)
R8	1	100kΩ ±1% resistor (0603)
R9–R13	0	Not installed, resistors—shorted with PCB trace (0603)
R16, R23	2	20kΩ ±1% resistors (0603)
R17	1	402Ω ±1% resistor (0603)
R18	1	4.02kΩ ±1% resistor (0603)
R19, R20, R21	3	1MΩ ±5% resistors (0603)
R22	1	1.65kΩ ±1% resistor (0603)
R24	0	Not installed, resistor (0603)
R25	1	8.06kΩ ±1% resistor (0603)
R26	1	6.65kΩ ±1% resistor (0603)
R27	1	0.1Ω ±1% current-sense resistor (1206) Vishay WSL1206R1000FEA
U1	1	Current-sense amplifier, 12-bit ADC (10 μMAX®) Maxim MAX9611AUB+
U2	1	Microcontroller (68 QFN-EP*) Maxim MAXQ2000-RAX+

DESIGNATION	QTY	DESCRIPTION
U3	1	2.5V LDO regulator (5 SC70) Maxim MAX8511EXK25+
U4	1	Adjustable-output LDO regulator (5 SC70) Maxim MAX8512EXK+
U5	1	1.8V LDO regulator (5 SC70) Maxim MAX8511EXK18+
U6	1	Level translator (10 μMAX) Maxim MAX1840EUB+
U7	1	UART-to-USB converter (32 TQFP)
U8	1	93C46 type 3-wire EEPROM (8 SO)
Y1	1	16MHz crystal (HCM49) Hong Kong X'tals SSM16000N1HK188F0-0
Y2	1	6MHz crystal (HCM49) Hong Kong X'tals SSL60000N1HK188F0-0
—	1	USB high-speed A-to-B cables, 6ft
—	5	Shunts
—	1	PCB: MAX9611 EVALUATION KIT+

*EP = Exposed pad.

Component Suppliers

SUPPLIER	PHONE	WEBSITE
Hong Kong X'tals Ltd.	852-35112388	www.hongkongcrystal.com
Murata Electronics North America, Inc.	770-436-1300	www.murata-northamerica.com
TDK Corp.	847-803-6100	www.component.tdk.com
Vishay	402-563-6866	www.vishay.com

Note: Indicate that you are using the MAX9611 when contacting these component suppliers.

MAX9611 EV Kit Files

FILE	DESCRIPTION
INSTALL.EXE	Installs the EV kit files on your computer
MAX9611.EXE	Application program
CDM20600.EXE	Installs the USB device driver
UNINSTALL.EXE	Uninstalls the EV kit software
USB_Driver_Help_200.PDF	USB driver installation help file

μMAX is a registered trademark of Maxim Integrated Products, Inc.

MAX9611 Evaluation Kit

Quick Start

Required Equipment

- MAX9611 EV kit (USB cable included)
- Windows XP, Windows Vista, or Windows 7 PC with a spare USB port
- 12V, 1.5A DC power supply
- Electronic load capable of sinking 1A (e.g., HP6060B)
- Three digital voltmeters (DVMs)

Note: In the following sections, software-related items are identified by bolding. Text in **bold** refers to items directly from the EV kit software. Text in **bold and underlined** refers to items from the Windows operating system.

Procedure

The EV kit is fully assembled and tested. Follow the steps below to verify board operation.

Caution: Do not turn on power supplies until all connections are completed.

- 1) Visit www.maxim-ic.com/evkitsoftware to download the latest version of the EV kit software, 9611Rxx.ZIP. Save the EV kit software to a temporary folder and unzip the ZIP file.
- 2) Install the EV kit software on your computer by running the INSTALL.EXE program inside the temporary folder. The program files are copied to your PC and icons are created in the Windows **Start | Programs** menu. During software installation, some versions of Windows may show a warning message indicating that this software is from an unknown publisher. This is not an error condition and it is safe to proceed with installation. Administrator privileges are required to install the USB device driver on Windows.
- 3) Verify that all jumpers (JU1–JU5) are in their default positions, as shown in Tables 1 and 2.
- 4) Set the DC power supply to 12V and connect to the VIN and the GND pads of the MAX9611 EV kit board.
- 5) Set the electronic load to sink 750mA. Connect the electronic load positive terminal to the LOAD pad and the negative terminal to the nearest GND pad.
- 6) Connect the first voltmeter between the RS+ and RS- test points.
- 7) Connect the second voltmeter between the SET test point and the nearest GND pad.
- 8) Connect the third voltmeter between the OUT test point and the nearest GND pad.
- 9) Connect the USB cable from the PC to the EV kit board. A Windows message appears when connecting the EV kit board to the PC for the first time. Each version of Windows has a slightly different message. If you see a Windows message stating **ready to use**, then proceed to the next step; otherwise, open the USB_Driver_Help_200.PDF document in the Windows **Start | Programs** menu to verify that the USB driver was installed successfully.
- 10) Turn on the power supply.
- 11) Start the EV kit software by opening its icon in the **Start | Programs** menu. The EV kit software main window appears, as shown in Figure 1. Observe as the program automatically detects the address of the device and starts the main program.
- 12) Verify that the **Value** within the **ADC** group box is accurate by monitoring the measurement on the voltmeters.

Detailed Description of Software

The user interface (Figure 1) is easy to operate; use the mouse or press the Tab key to navigate with the arrow keys. Each of the buttons correspond to bits in the command and configuration bytes. By pressing these buttons, the correct I²C-compatible write operation is

Table 1. Jumper Description (JU1, JU2, JU3)

JUMPER	SHUNT POSITION	DESCRIPTION
JU1	1-2*	Connects the device to the on-board +3.3V DC supply.
	2-3	Connects the device to the user-supplied +2.7V to +5.5V supply.
JU2	1-2*	Connects the device to the on-board SDA.
	2-3	Connects the device to the user-supplied SDA.
JU3	1-2*	Connects the device to the on-board SCL.
	2-3	Connects the device to the user-supplied SCL.

*Default position.

MAX9611 Evaluation Kit

generated to update the internal registers of the device. The **Interface** group box indicates the current I²C-compatible **Device Address**, **Register Address Sent**, and the **Data Sent/Received** for the last read/write operation. This data is used to confirm proper device operation.

Control Register

The device can be used in two different configurations, op-amp mode or comparator mode. Using the part in op-amp mode operates the transistor (M1) in its linear region, thus limiting the current source into the LOAD pad. Using the part in comparator mode operates M1 as a switch, thus disconnecting the load from the VIN pad in the event of an over-limit condition.

The **MUX** drop-down list is used to read the current-sense amplifier output from the ADC (1x, 4x, 8x), common-mode voltage, OUT voltage, SET voltage, and die temperature. The **MODE** drop-down list allows the user to choose different modes within the op-amp and comparator configuration. If **OUT Latch with Delay and Auto-Retry** is selected, then a **Delay Time** and **Retry Time** group box appears in the main window. The **Delay Time** group box has **1ms** and **100us** radio button options. The **Retry Time** group box has **50ms** and **10ms** radio button options. See the MAX9611 IC data sheet for a detailed description. Check the **SHDN** checkbox to have the part enter shutdown mode.

ADC

Select the desired ADC reading from the **MUX** drop-down list.

Current-Sense Input Voltage

CSA is the current-sense amplifier input voltage. The **MUX** drop-down list allows the user to select gains of 1x, 4x, or 8x, which correspond to full-scale voltages of 440mV, 110mV, and 55mV, and LSBs of 107.5μV, 26.88μV, and 13.44μV, respectively. The RS+ and RS- test points of the EV kit can be used to verify the data.

Common-Mode Voltage

Common-mode voltage is the average of the voltage at RS+ and RS- that is displayed under **VCM**. The common-mode voltage range is from 0 to 57.3V and the LSB is

14mV. Select **011- Channel B: Common Mode Voltage from ADC** from the **MUX** drop-down list for this reading.

OUT Voltage

The internal op-amp or comparator output voltage can be monitored over the 0 to 57.3V range by the ADC and the LSB is 14mV. Select **100- Channel C: OUT Voltage from ADC** from the **MUX** drop-down list for this reading. The OUT voltage can be verified through the OUT test point on the EV kit.

SET Voltage

The SET voltage (SET test point) is determined through resistor-divider R22 and R23. The SET voltage range is from 0 to 1.10V and has an LSB of 268μV. Select **101- Channel D: SET Voltage from ADC** from the **MUX** drop-down list for this reading.

Temperature

The die temperature can be read by the ADC by selecting **110- Channel E: Temperature from ADC** from the **MUX** drop-down list. The temperature range is from -40°C to +127°C and has an LSB of +0.48°C.

Data Logging

All ADC data is saved to a .csv file when the **Data Logging** checkbox is checked.

Advanced User Interface

There are two methods for communicating with the device. The first is through the window shown in Figure 1. The second is through the **Advanced User Interface** window shown in Figure 2. The **Advanced User Interface** window becomes available by selecting the **Options | Interface (Advanced User)** menu item and allows execution of serial commands manually.

An **Advanced User Interface window** can be used as a debug tool because it is capable of manually reading and writing to every register of the device.

Detailed Description of Hardware

The MAX9611 EV kit is an assembled and tested PCB used to evaluate the MAX9611 high-side current-sense amplifier with an integrated 12-bit ADC and a gain block that can be configured either as an op amp or as a comparator.

MAX9611 Evaluation Kit

Evaluates: MAX9611/MAX9612

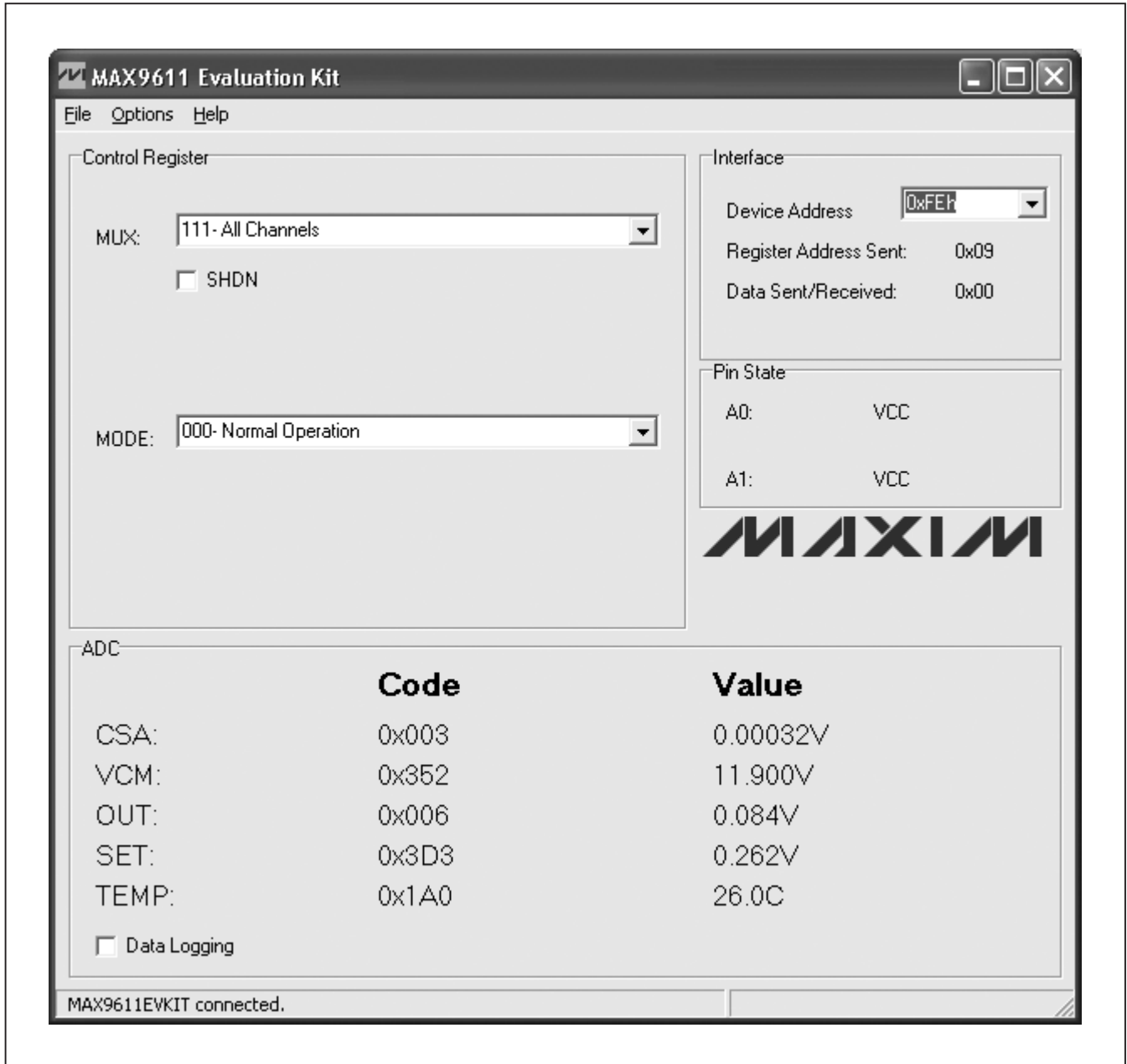

Figure 1. MAX9611 EV Kit Software Main Window

MAX9611 Evaluation Kit

Address Selection

The device's slave I²C address is configured through the A1 and A0 pins. The EV kit features jumpers JU4 and JU5 to configure these pins. The default address is 1111 111 (R/W). See Table 2 for a complete list of addresses. Verify that the new I²C address matches the address shown in the software's **Device Address** combo box.

User-Supplied Power Supply

The EV kit is powered completely from the USB port by default. Move the shunt on jumper JU1 to the 2-3 position and apply a 2.7V to 5.5V power supply between the VCC1 and GND pads.

User-Supplied I²C

To use the device with a user-supplied I²C interface, first move the shunts on jumpers JU2 and JU3 to the 2-3 position. Next apply a user-supplied 2.7V to 5.5V power supply at the VCC1 and GND pads. Lastly, connect SCL and SDA to the corresponding pads on the EV kit.

Evaluating the MAX9612

When installing the MAX9612 into U1 of the EV kit, the following steps must be completed. Remove resistor R24 and populate R25 with the appropriate pullup resistor. The EV kit can only use the MAX9612 as a comparator and not as an op amp because of an absence of an n-channel MOSFET on board. For proper operation, supply the source voltage between the VIN_ALT and GND pads instead of between VIN and GND pads.

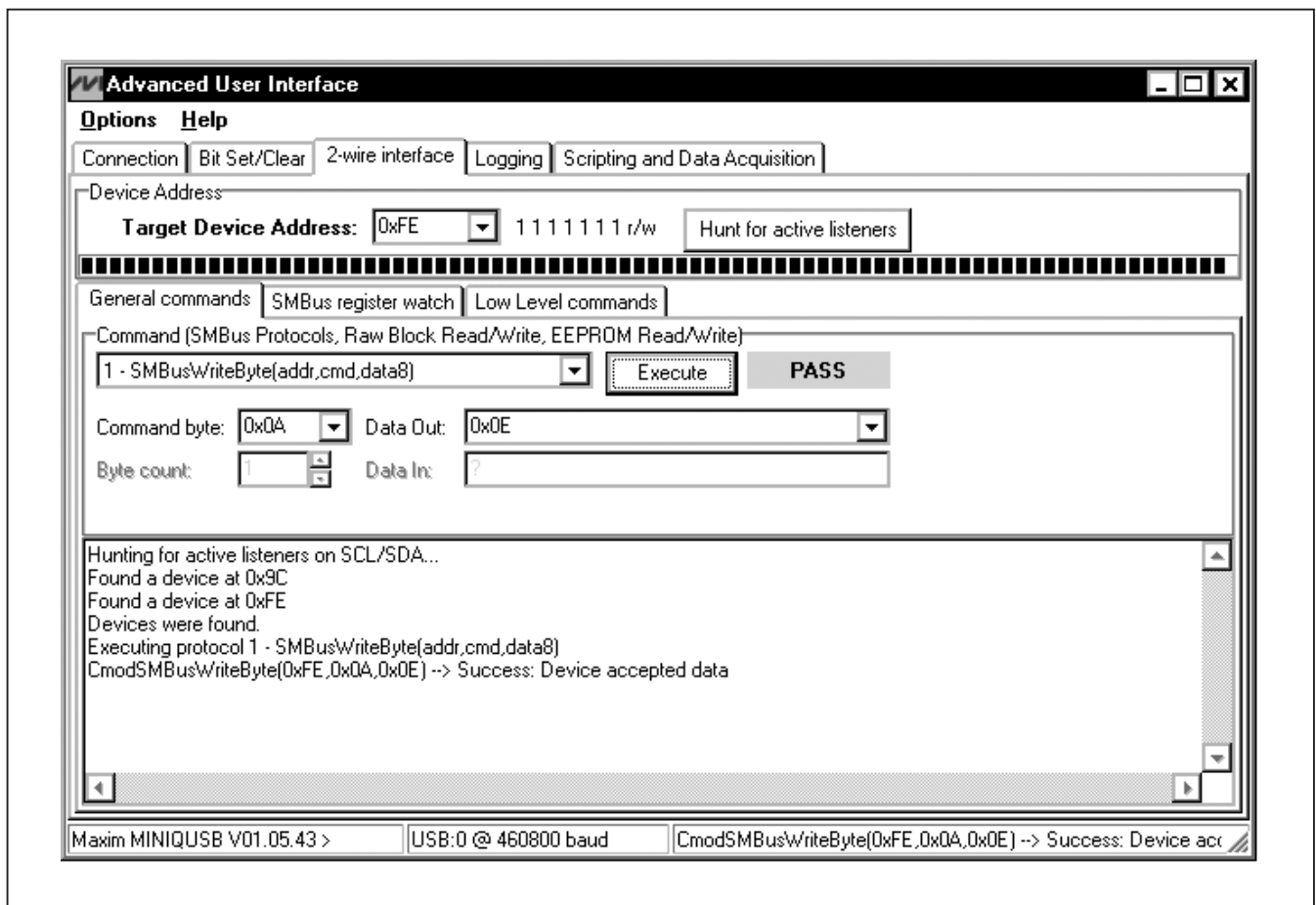

Figure 2. Example of an SMBusWriteByte Operation Using the Advanced User Interface

MAX9611 Evaluation Kit

Evaluates: MAX9611/MAX9612

Table 2. Shunt Setting for SMBus/I²C Address

SHUNT POSITION		B7	B6	B5	B4	B3	B2	B1	B0	WRITE ADDRESS (hex)	READ ADDRESS (hex)
JU4 (A1)	JU5 (A0)										
1-5	1-5	1	1	1	0	0	0	0	R/ \overline{W}	0xE0	0xE1
1-5	1-4	1	1	1	0	0	0	1	R/ \overline{W}	0xE2	0xE3
1-5	1-3	1	1	1	0	0	1	0	R/ \overline{W}	0xE4	0xE5
1-5	1-2	1	1	1	0	0	1	1	R/ \overline{W}	0xE6	0xE7
1-4	1-5	1	1	1	0	1	0	0	R/ \overline{W}	0xE8	0xE9
1-4	1-4	1	1	1	0	1	0	1	R/ \overline{W}	0xEA	0xEB
1-4	1-3	1	1	1	0	1	1	0	R/ \overline{W}	0xEC	0xED
1-4	1-2	1	1	1	0	1	1	1	R/ \overline{W}	0xEE	0xEF
1-3	1-5	1	1	1	1	0	0	0	R/ \overline{W}	0xF0	0xF1
1-3	1-4	1	1	1	1	0	0	1	R/ \overline{W}	0xF2	0xF3
1-3	1-3	1	1	1	1	0	1	0	R/ \overline{W}	0xF4	0xF5
1-3	1-2	1	1	1	1	0	1	1	R/ \overline{W}	0xF6	0xF7
1-2	1-5	1	1	1	1	1	0	0	R/ \overline{W}	0xF8	0xF9
1-2	1-4	1	1	1	1	1	0	1	R/ \overline{W}	0xFA	0xFB
1-2	1-3	1	1	1	1	1	1	0	R/ \overline{W}	0xFC	0xFD
1-2*	1-2*	1	1	1	1	1	1	1	R/ \overline{W}	0xFE	0xFF

*Default position.

MAX9611 Evaluation Kit

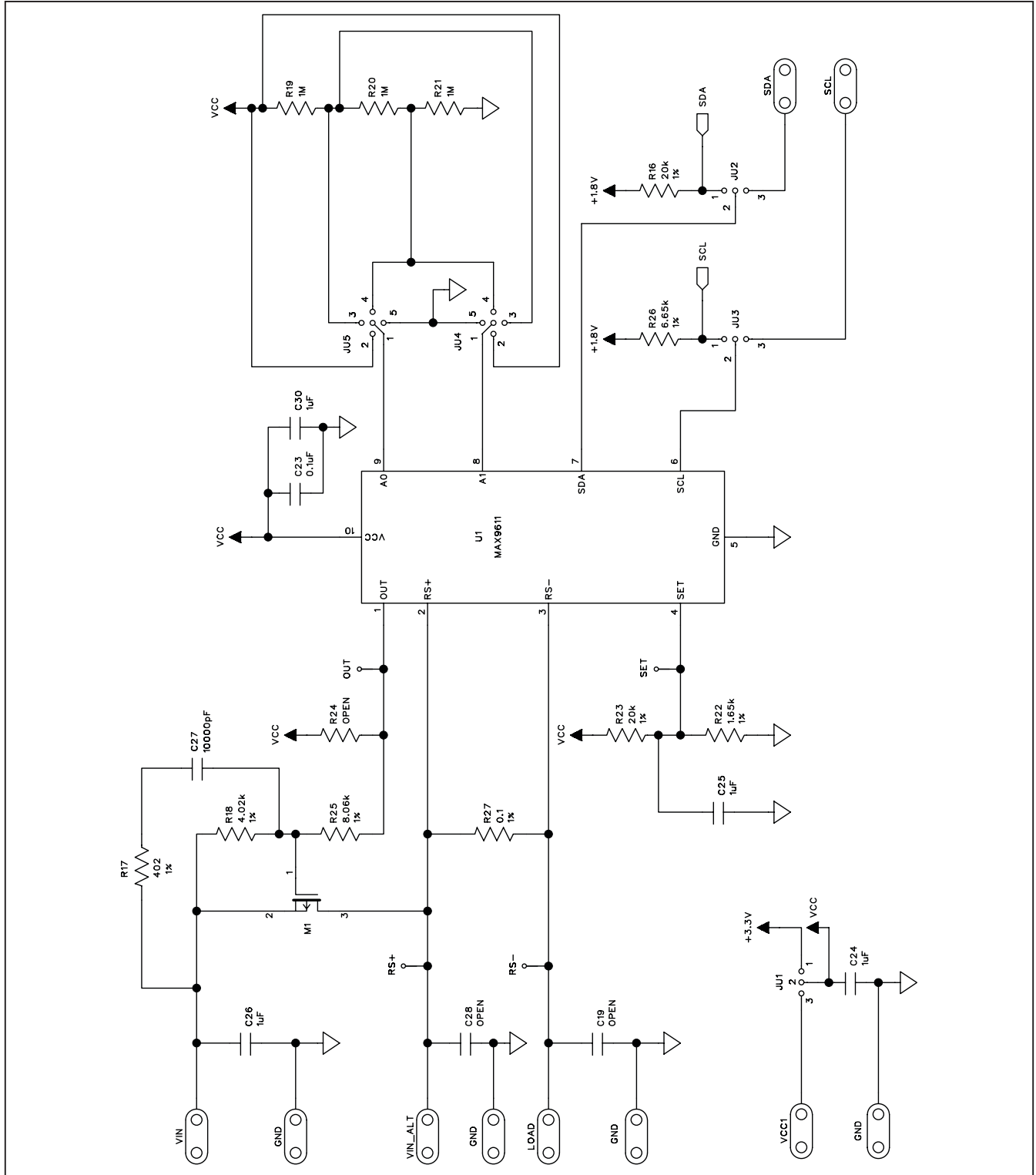

Figure 3a. MAX9611 EV Kit Schematic (Sheet 1 of 2)

MAX9611 Evaluation Kit

Evaluates: MAX9611/MAX9612

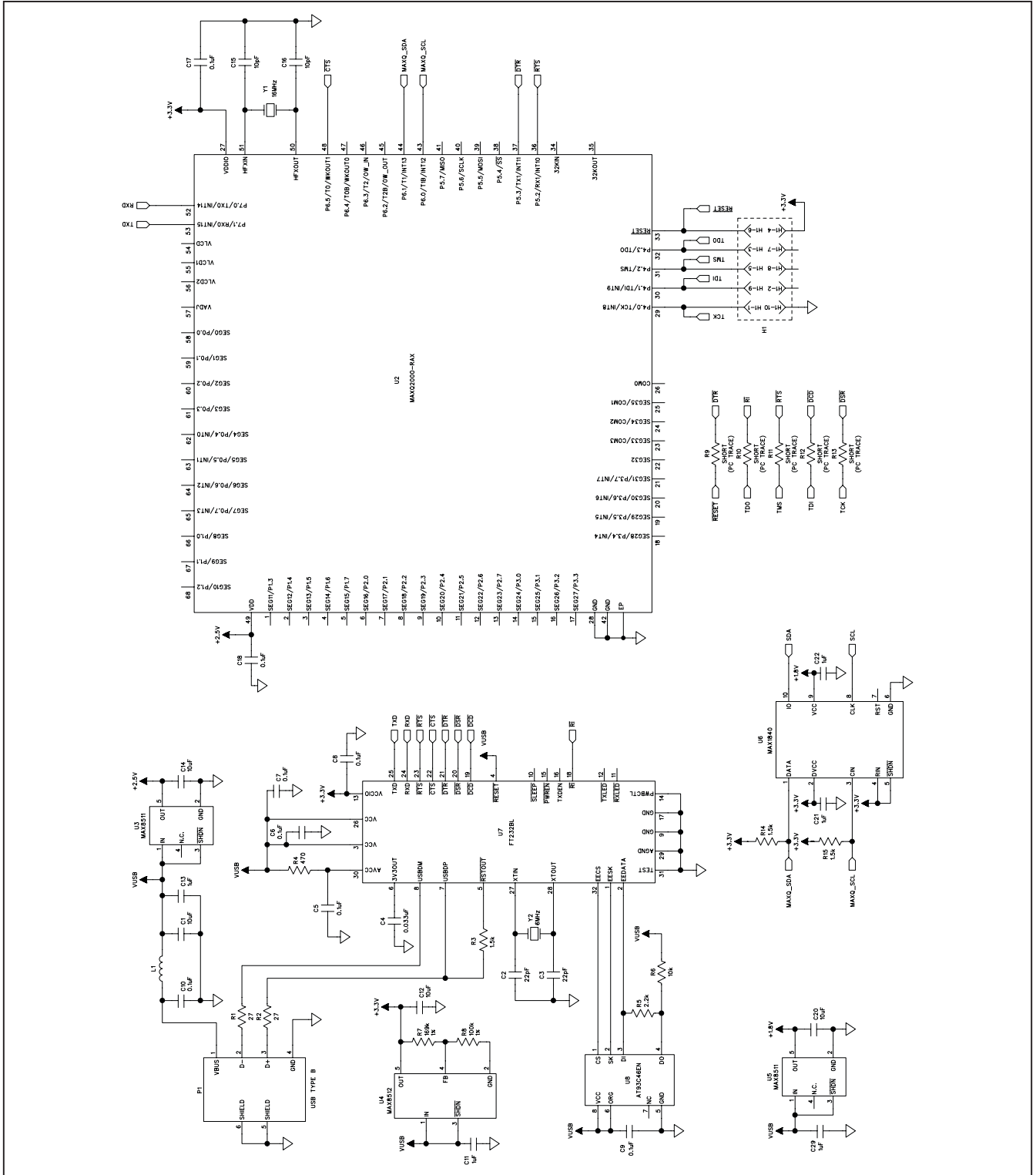

Figure 3b. MAX9611 EV Kit Schematic (Sheet 2 of 2)

MAX9611 Evaluation Kit

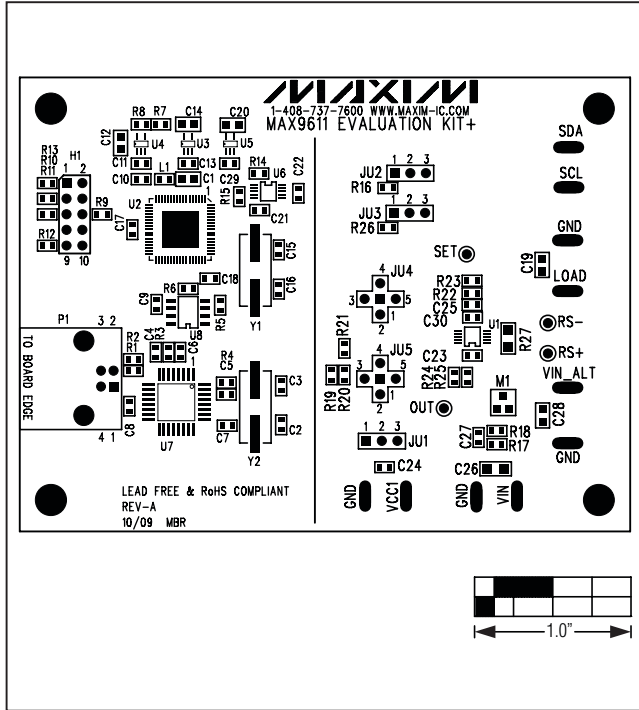

Figure 4. MAX9611 EV Kit Component Placement Guide—Component Side

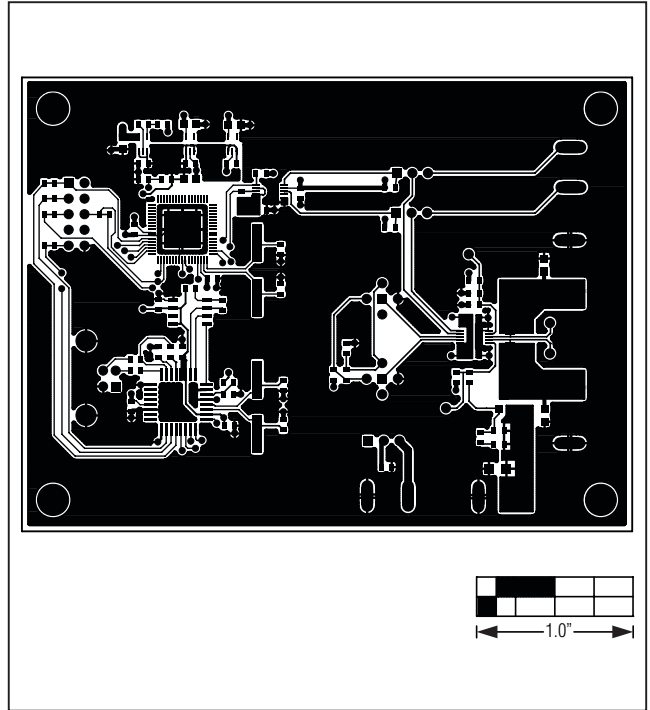

Figure 5. MAX9611 EV Kit PCB Layout—Component Side

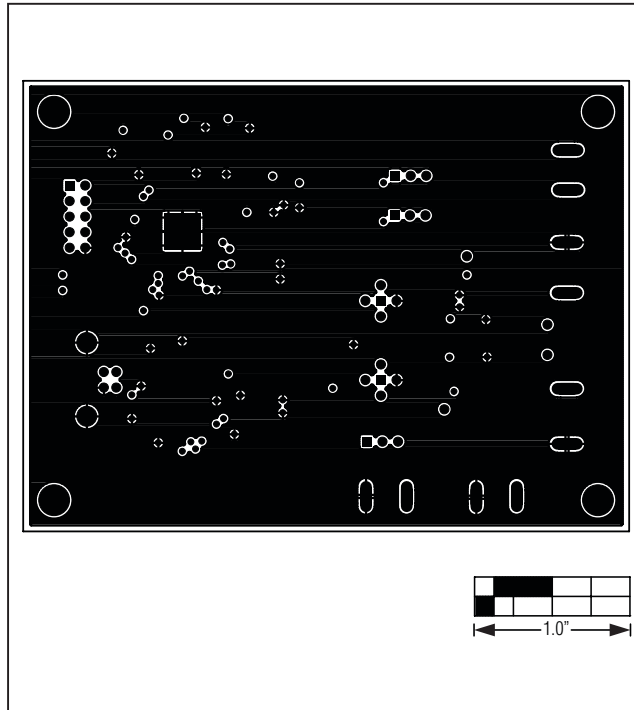

Figure 6. MAX9611 EV Kit PCB Layout—Inner Layer 2

MAX9611 Evaluation Kit

Evaluates: MAX9611/MAX9612

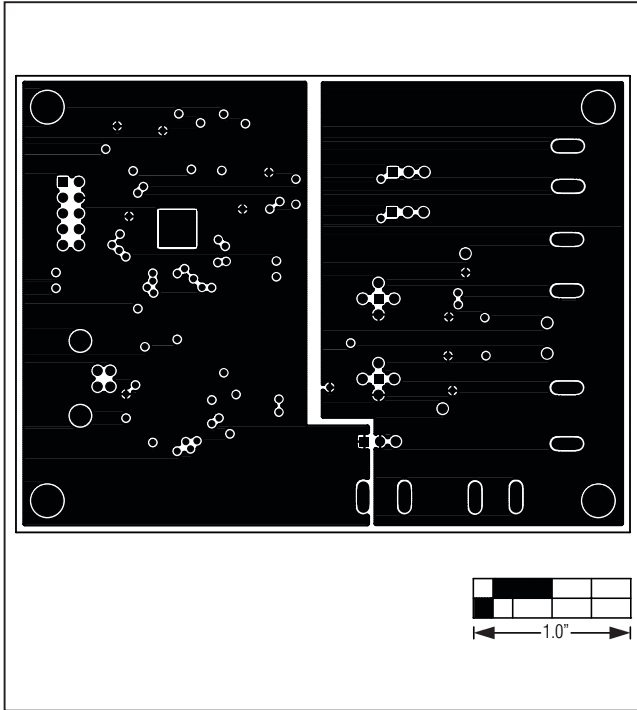

Figure 7. MAX9611 EV Kit PCB Layout—Inner Layer 3

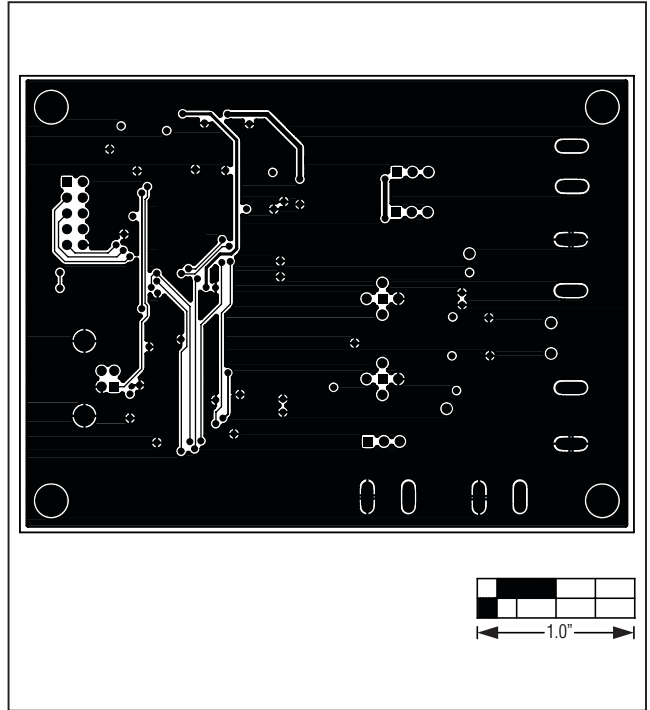

Figure 8. MAX9611 EV Kit PCB Layout—Solder Side

MAX9611 Evaluation Kit

Evaluates: MAX9611/MAX9612

Revision History

REVISION NUMBER	REVISION DATE	DESCRIPTION	PAGES CHANGED
0	11/10	Initial release	—

Maxim cannot assume responsibility for use of any circuitry other than circuitry entirely embodied in a Maxim product. No circuit patent licenses are implied. Maxim reserves the right to change the circuitry and specifications without notice at any time.

12 **Maxim Integrated Products, 120 San Gabriel Drive, Sunnyvale, CA 94086 408-737-7600**

© 2010 Maxim Integrated Products

Maxim is a registered trademark of Maxim Integrated Products, Inc.