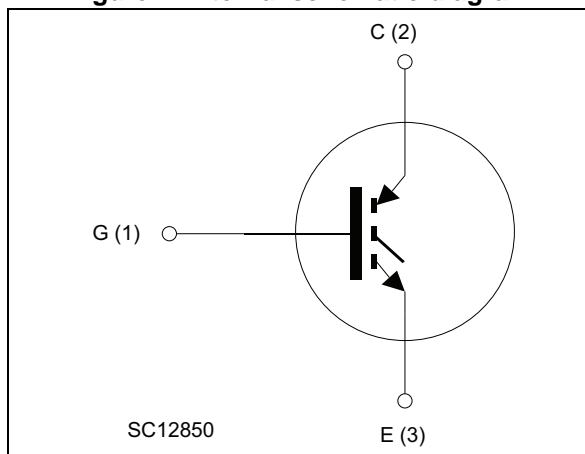

Figure 1. Internal schematic diagram



Features

- Maximum junction temperature: $T_J = 175\text{ °C}$
- High speed switching series
- Minimized tail current
- $V_{CE(sat)} = 2.1\text{ V (typ.) @ } I_C = 25\text{ A}$
- 5 μs minimum short circuit withstand time at $T_J = 150\text{ °C}$
- Tight parameters distribution
- Safe paralleling
- Low thermal resistance

Applications

- Uninterruptible power supply
- Welding machines
- Photovoltaic inverters
- Power factor correction
- High frequency converters

Description

These devices are IGBTs developed using an advanced proprietary trench gate field-stop structure. These devices are part of the H series of IGBTs, which represent an optimum compromise between conduction and switching losses to maximize the efficiency of high switching frequency converters. Moreover, a slightly positive $V_{CE(sat)}$ temperature coefficient and very tight parameter distribution result in safer paralleling operation.

Table 1. Device summary

Order code	Marking	Package	Packaging
STGW25H120F2	G25H120F2	TO-247	Tube
STGWA25H120F2	G25H120F2	TO-247 long leads	Tube

Contents

1	Electrical ratings	3
2	Electrical characteristics	4
2.1	Electrical characteristics (curves)	6
3	Test circuits	11
4	Package information	12
4.1	TO-247, package information	12
4.2	TO-247 long leads, package information	14
5	Revision history	16

1 Electrical ratings

Table 2. Absolute maximum ratings

Symbol	Parameter	Value	Unit
V_{CES}	Collector-emitter voltage ($V_{GE} = 0$)	1200	V
I_C	Continuous collector current at $T_C = 25\text{ °C}$	50	A
I_C	Continuous collector current at $T_C = 100\text{ °C}$	25	A
$I_{CP}^{(1)}$	Pulsed collector current	100	A
V_{GE}	Gate-emitter voltage	± 20	V
P_{TOT}	Total dissipation at $T_C = 25\text{ °C}$	375	W
T_{STG}	Storage temperature range	-55 to 150	°C
T_J	Operating junction temperature	-55 to 175	°C

1. Pulse width limited by maximum junction temperature

Table 3. Thermal data

Symbol	Parameter	Value	Unit
R_{thJC}	Thermal resistance junction-case	0.4	°C/W
R_{thJA}	Thermal resistance junction-ambient	50	°C/W

2 Electrical characteristics

$T_J = 25\text{ °C}$ unless otherwise specified.

Table 4. Static characteristics

Symbol	Parameter	Test conditions	Min.	Typ.	Max.	Unit
$V_{(BR)CES}$	Collector-emitter breakdown voltage ($V_{GE} = 0$)	$I_C = 2\text{ mA}$	1200			V
$V_{CE(sat)}$	Collector-emitter saturation voltage	$V_{GE} = 15\text{ V}, I_C = 25\text{ A}$		2.1	2.6	V
		$V_{GE} = 15\text{ V}, I_C = 25\text{ A}$ $T_J = 125\text{ °C}$		2.4		
		$V_{GE} = 15\text{ V}, I_C = 25\text{ A}$ $T_J = 175\text{ °C}$		2.5		
$V_{GE(th)}$	Gate threshold voltage	$V_{CE} = V_{GE}, I_C = 1\text{ mA}$	5	6	7	V
I_{CES}	Collector cut-off current ($V_{GE} = 0$)	$V_{CE} = 1200\text{ V}$			25	μA
I_{GES}	Gate-emitter leakage current ($V_{CE} = 0$)	$V_{GE} = \pm 20\text{ V}$			250	nA

Table 5. Dynamic characteristics

Symbol	Parameter	Test conditions	Min.	Typ.	Max.	Unit
C_{ies}	Input capacitance	$V_{CE} = 25\text{ V}, f = 1\text{ MHz},$ $V_{GE} = 0$	-	2010	-	pF
C_{oes}	Output capacitance		-	146	-	pF
C_{res}	Reverse transfer capacitance		-	49	-	pF
Q_g	Total gate charge	$V_{CC} = 960\text{ V}, I_C = 25\text{ A},$ $V_{GE} = 15\text{ V},$ see Figure 23	-	100	-	nC
Q_{ge}	Gate-emitter charge		-	11	-	nC
Q_{gc}	Gate-collector charge		-	52	-	nC

Table 6. Switching characteristics (inductive load)

Symbol	Parameter	Test conditions	Min.	Typ.	Max.	Unit
$t_{d(on)}$	Turn-on delay time	$V_{CE} = 600\text{ V}$, $I_C = 25\text{ A}$, $R_G = 10\ \Omega$, $V_{GE} = 15\text{ V}$, see Figure 22	-	29	-	ns
t_r	Current rise time		-	12	-	ns
$(di/dt)_{on}$	Turn-on current slope		-	1774	-	A/ μ s
$t_{d(off)}$	Turn-off delay time		-	130	-	ns
t_f	Current fall time		-	106	-	ns
$E_{on}^{(1)}$	Turn-on switching losses		-	0.6	-	mJ
$E_{off}^{(2)}$	Turn-off switching losses		-	0.7	-	mJ
E_{ts}	Total switching losses	-	1.3	-	mJ	
$t_{d(on)}$	Turn-on delay time	$V_{CE} = 600\text{ V}$, $I_C = 25\text{ A}$, $R_G = 10\ \Omega$, $V_{GE} = 15\text{ V}$, $T_J = 175\text{ }^\circ\text{C}$, see Figure 22	-	27.5	-	ns
t_r	Current rise time		-	13.5	-	ns
$(di/dt)_{on}$	Turn-on current slope		-	1522	-	A/ μ s
$t_{d(off)}$	Turn-off delay time		-	139	-	ns
t_f	Current fall time		-	200	-	ns
$E_{on}^{(1)}$	Turn-on switching losses		-	1.05	-	mJ
$E_{off}^{(2)}$	Turn-off switching losses		-	1.65	-	mJ
E_{ts}	Total switching losses	-	2.7	-	mJ	
t_{sc}	Short-circuit withstand time	$V_{CE} = 600\text{ V}$, $V_{GE} = 15\text{ V}$, $T_J = 150\text{ }^\circ\text{C}$,	5		-	μ s

1. Energy losses include reverse recovery of the external diode.
2. Turn-off losses include also the tail of the collector current.

2.1 Electrical characteristics (curves)

Figure 2. Power dissipation vs. case temperature

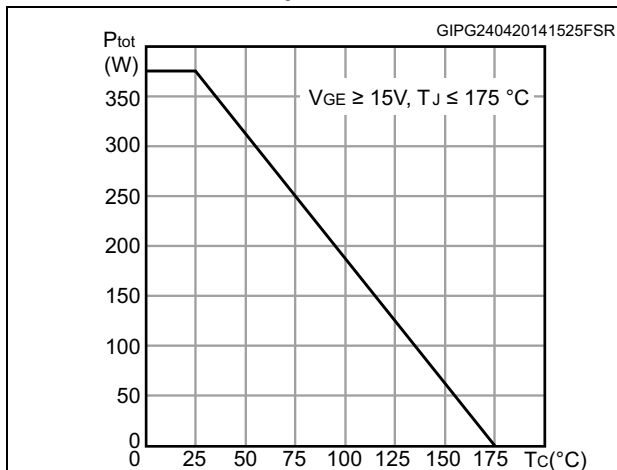

Figure 3. Collector current vs. case temperature

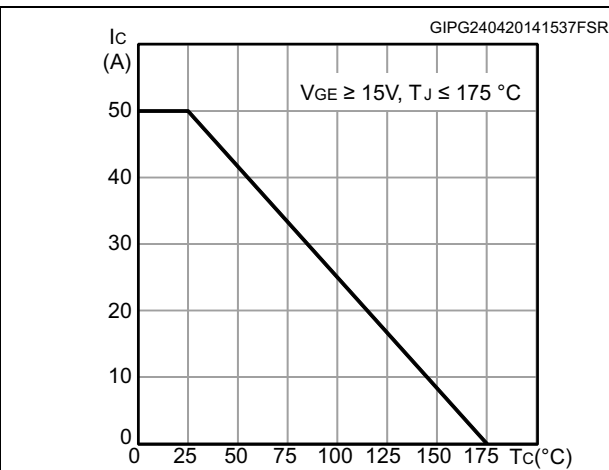

Figure 4. Output characteristics (T_J = 25°C)

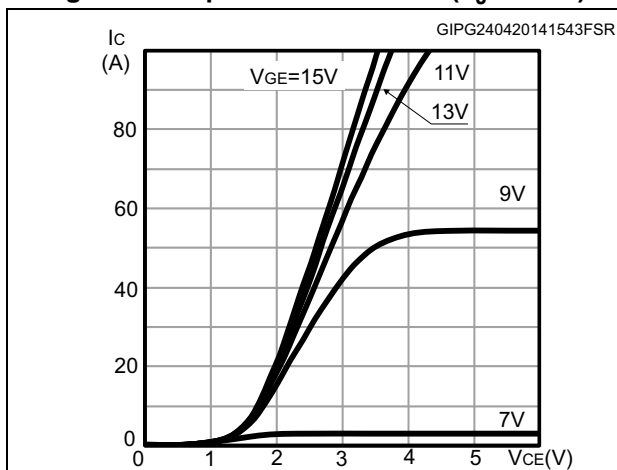

Figure 5. Output characteristics (T_J = 175°C)

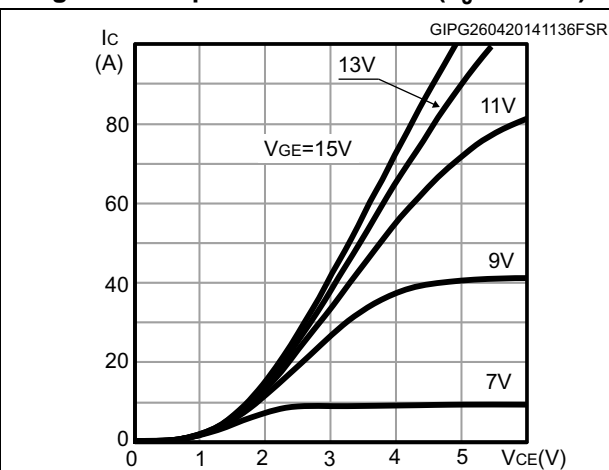

Figure 6. V_{CE(sat)} vs. junction temperature

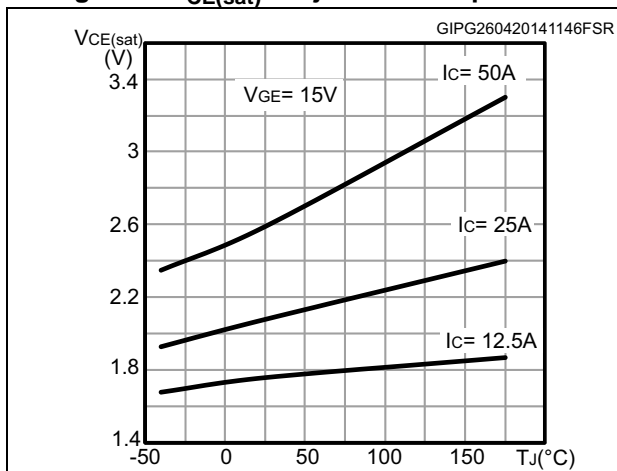

Figure 7. V_{CE(sat)} vs. collector current

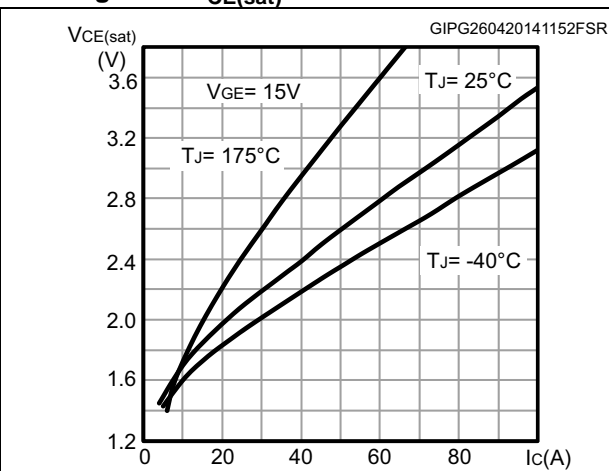

Figure 8. Collector current vs. switching frequency

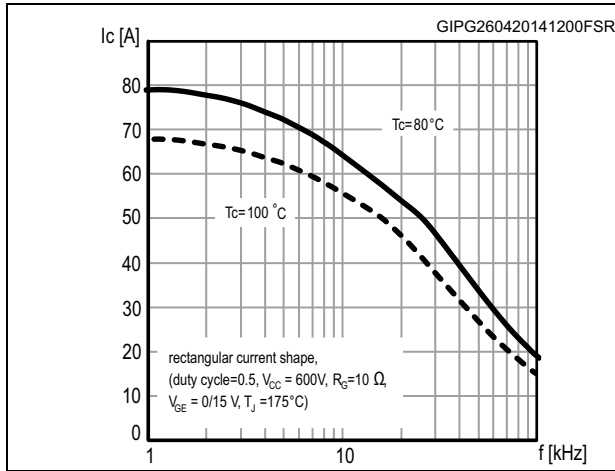

Figure 9. Forward bias safe operating area

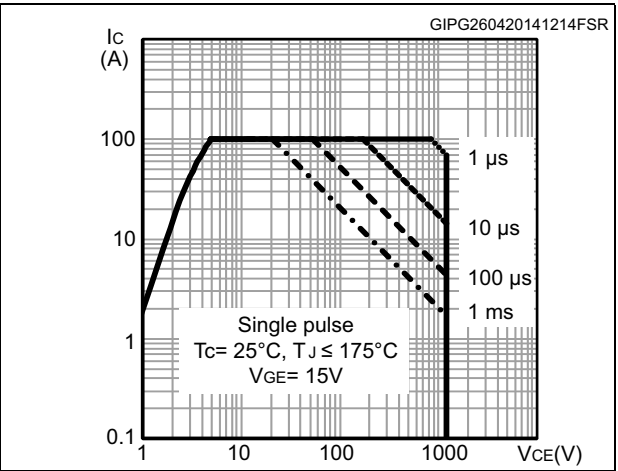

Figure 10. Transfer characteristics

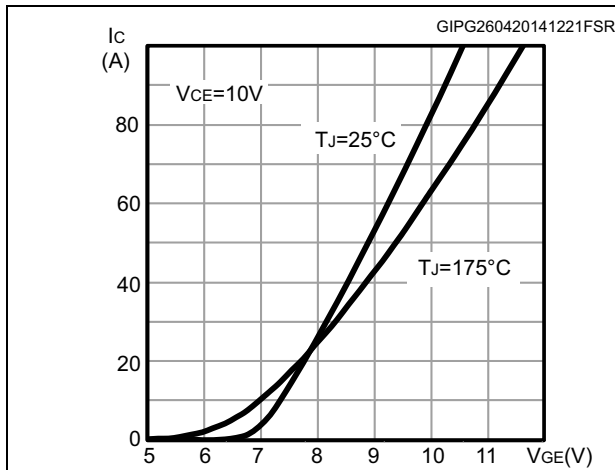

Figure 11. Normalized $V_{GE(th)}$ vs junction temperature

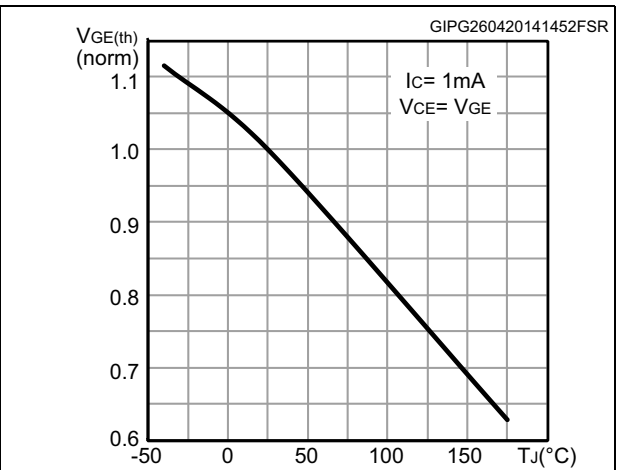

Figure 12. Normalized $V_{(BR)CES}$ vs. junction temperature

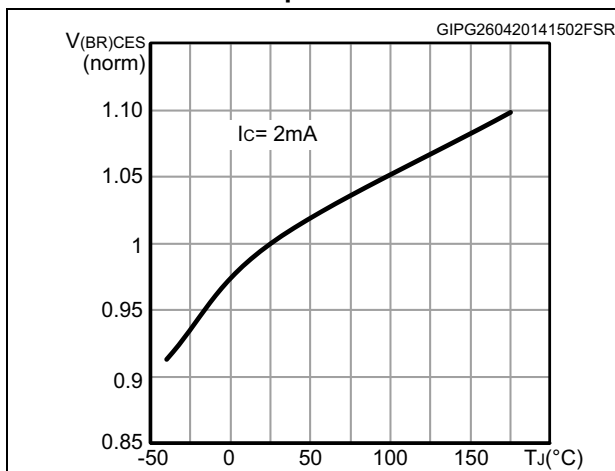

Figure 13. Capacitance variation

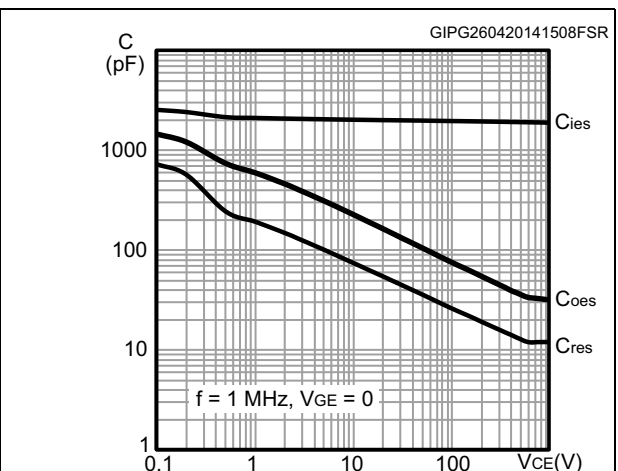

Figure 14. Gate charge vs. gate-emitter voltage

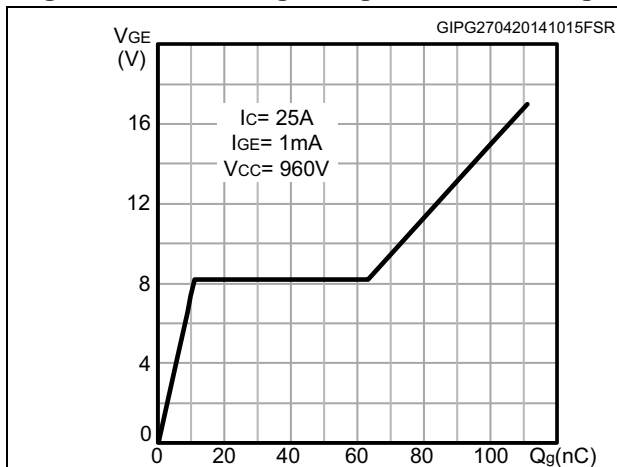

Figure 15. Switching loss vs collector current

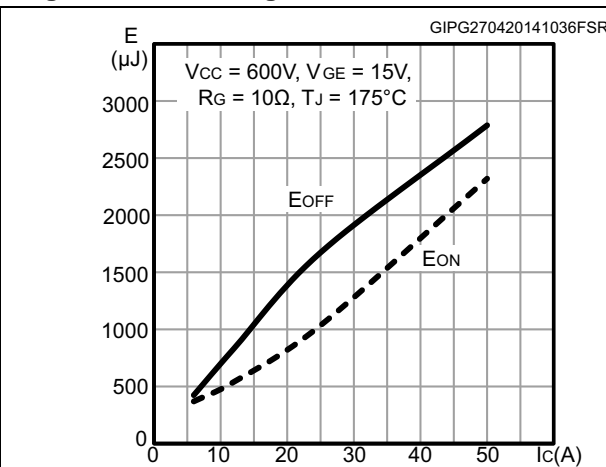

Figure 16. Switching loss vs gate resistance

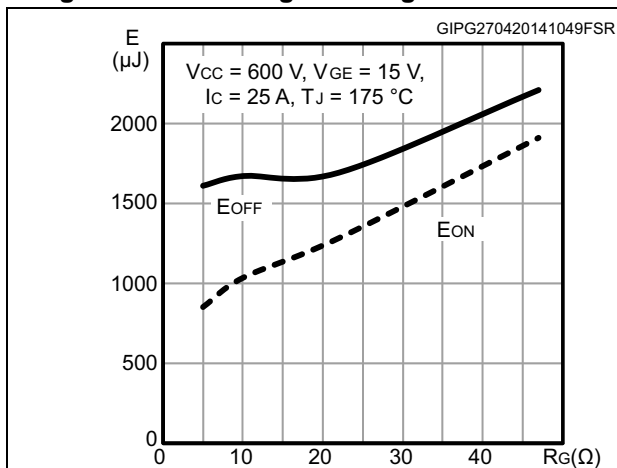

Figure 17. Switching loss vs temperature

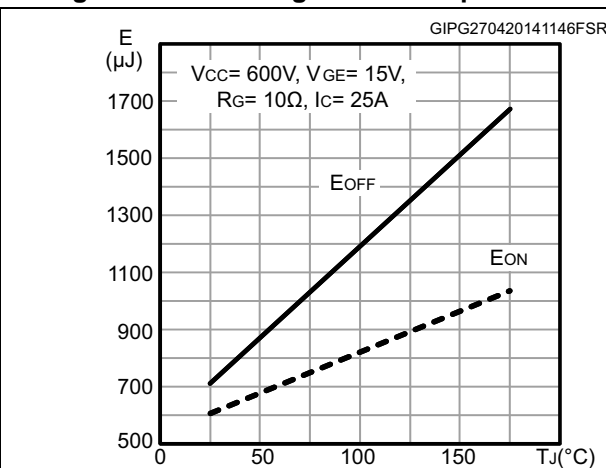

Figure 18. Switching loss vs collector-emitter voltage

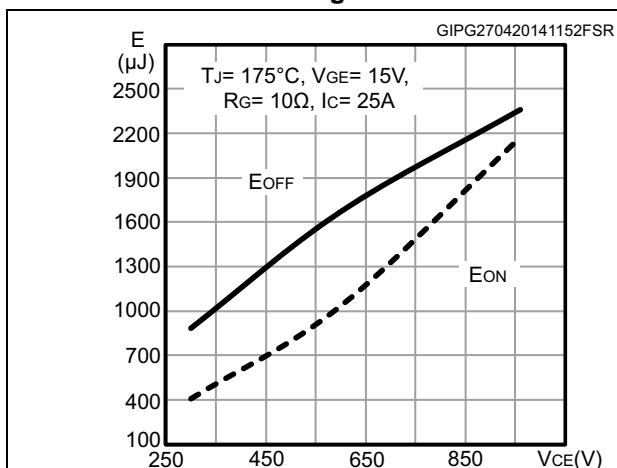
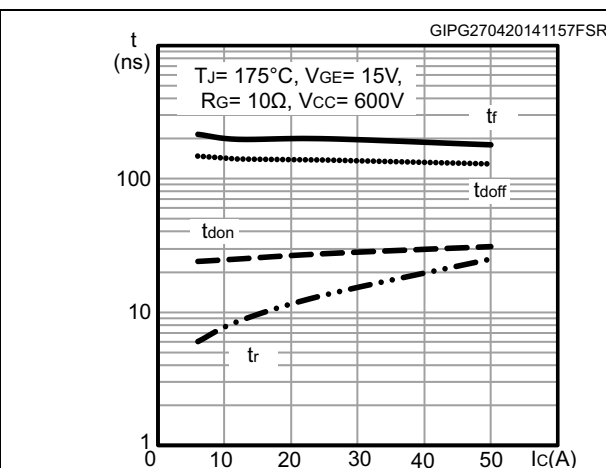

Figure 19. Switching times vs. collector current



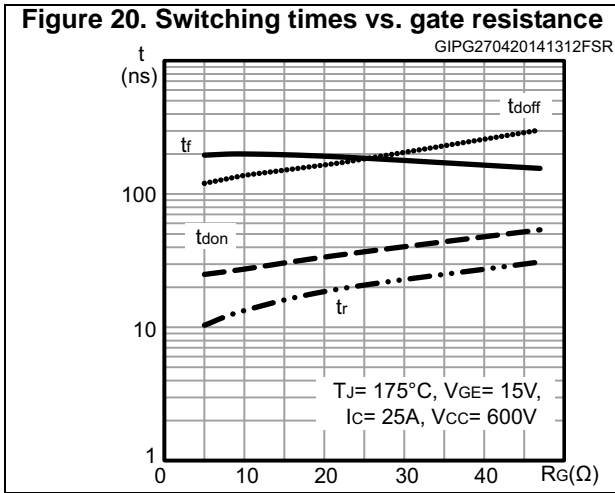
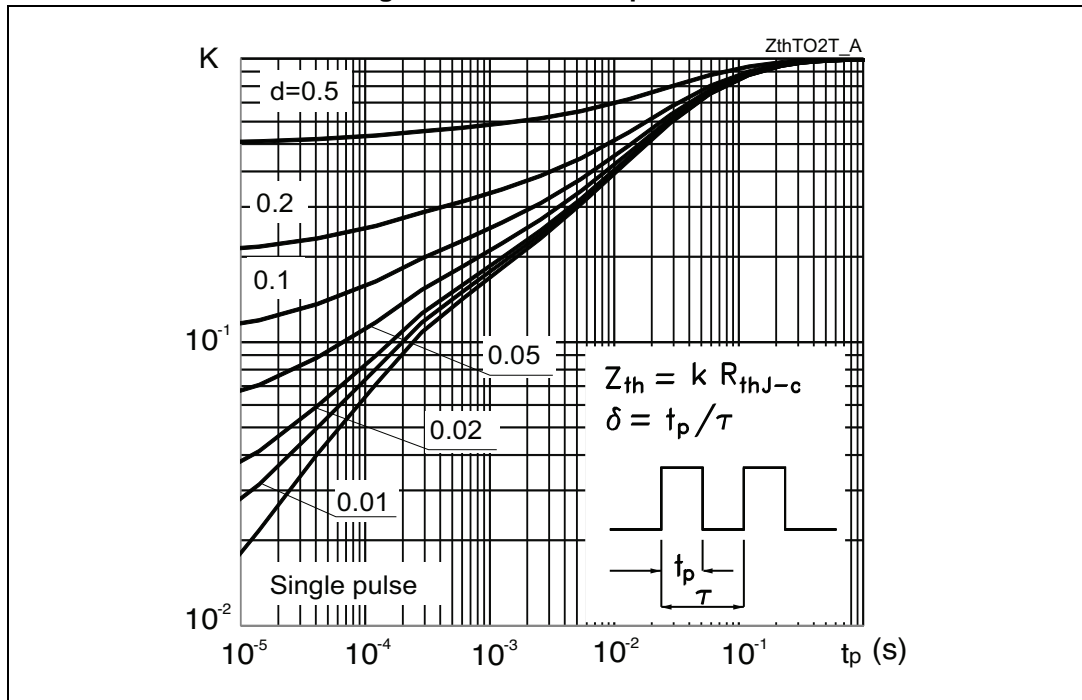

Figure 21. Thermal impedance



4 Package information

In order to meet environmental requirements, ST offers these devices in different grades of ECOPACK[®] packages, depending on their level of environmental compliance. ECOPACK[®] specifications, grade definitions and product status are available at: www.st.com. ECOPACK[®] is an ST trademark.

4.1 TO-247, package information

Figure 25. TO-247 outline

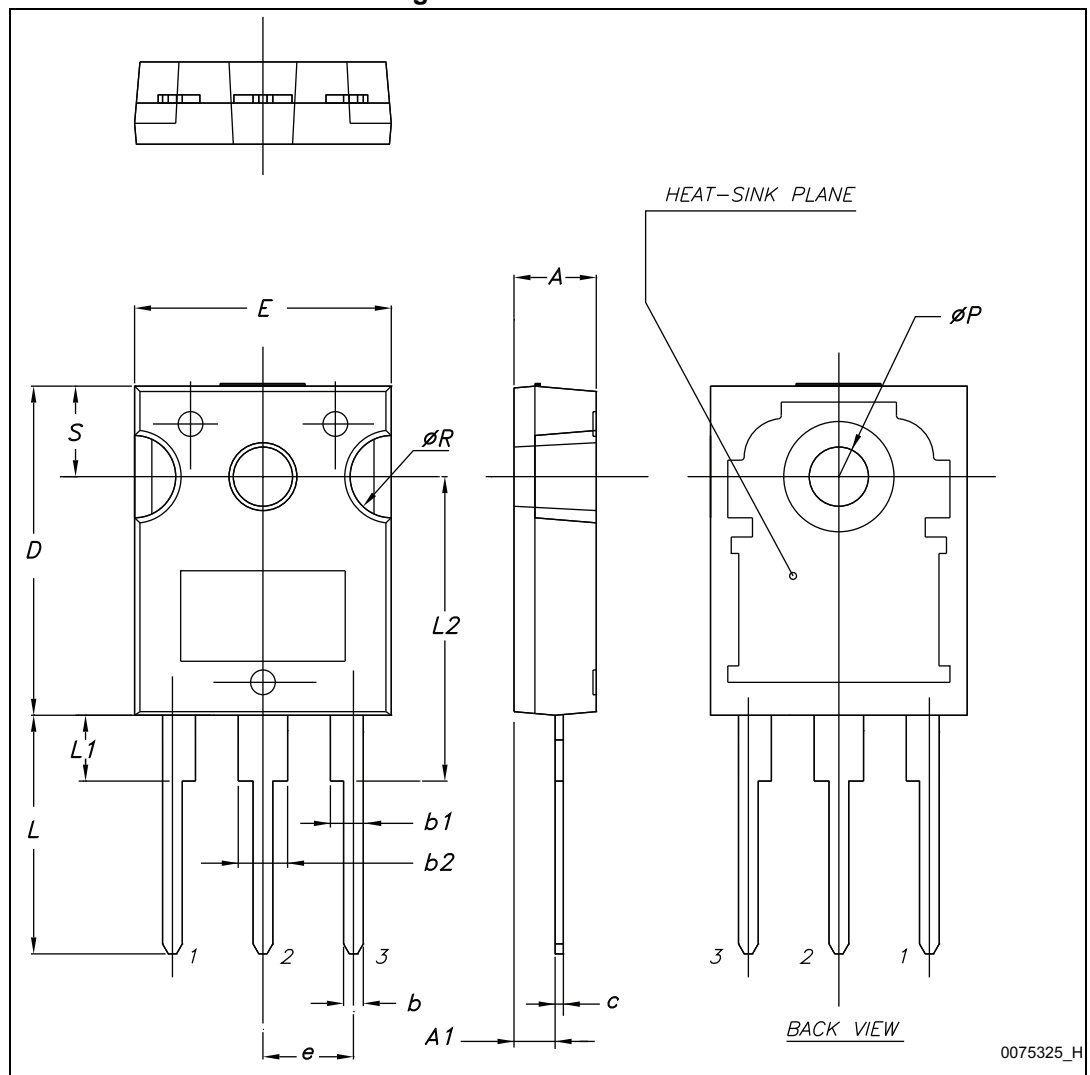
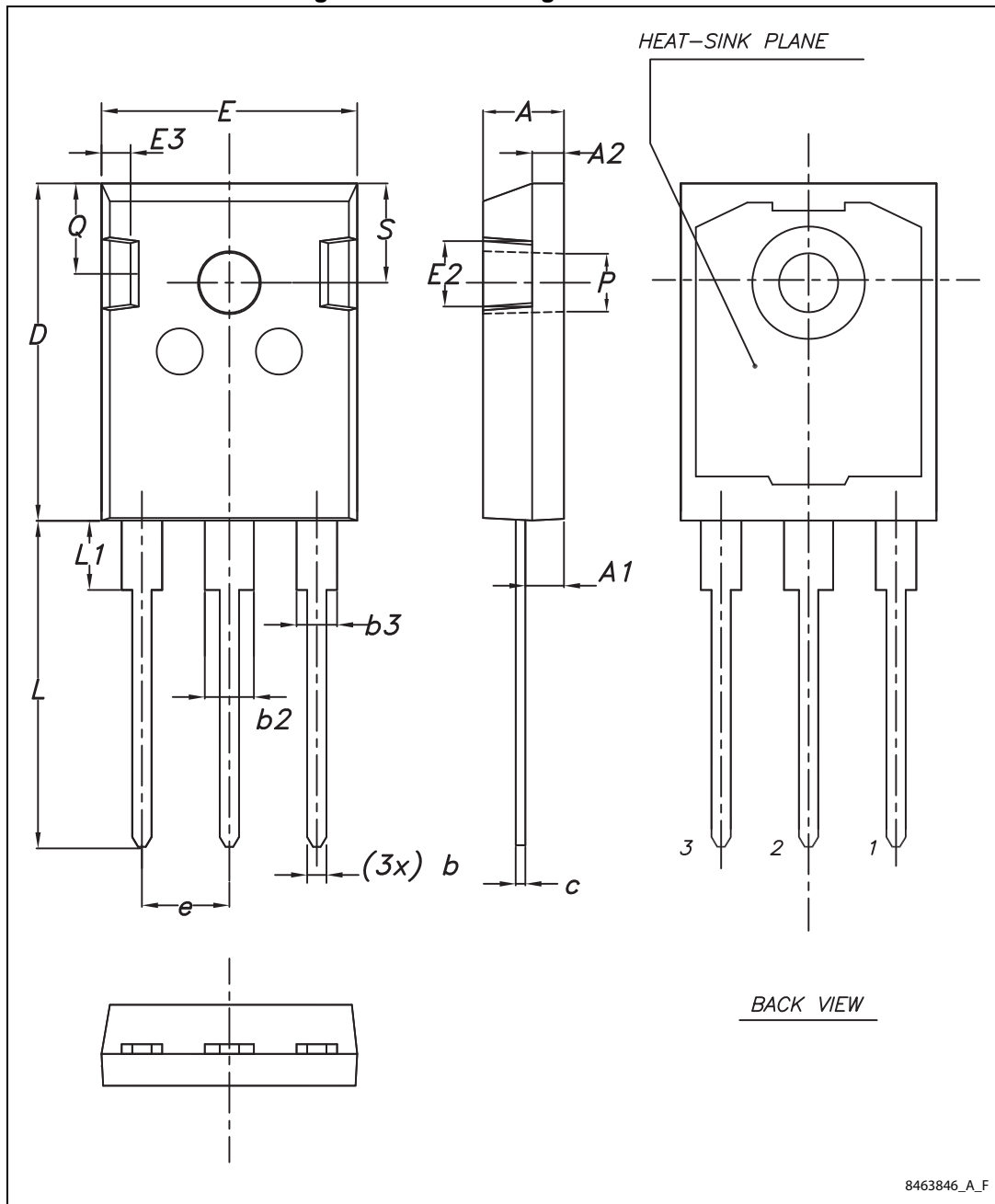

Table 7. TO-247 mechanical data

Dim.	mm.		
	Min.	Typ.	Max.
A	4.85		5.15
A1	2.20		2.60
b	1.0		1.40
b1	2.0		2.40
b2	3.0		3.40
c	0.40		0.80
D	19.85		20.15
E	15.45		15.75
e	5.30	5.45	5.60
L	14.20		14.80
L1	3.70		4.30
L2		18.50	
ØP	3.55		3.65
ØR	4.50		5.50
S	5.30	5.50	5.70

4.2 TO-247 long leads, package information

Figure 26. TO-247 long leads outline



8463846_A_F

Table 8. TO-247 long leads mechanical data

Dim.	mm		
	Min.	Typ.	Max.
A	4.90	5.00	5.10
A1	2.31	2.41	2.51
A2	1.90	2.00	2.10
b	1.16		1.26
b2			3.25
b3			2.25
c	0.59		0.66
D	20.90	21.00	21.10
E	15.70	15.80	15.90
E2	4.90	5.00	5.10
E3	2.40	2.50	2.60
e	5.34	5.44	5.54
L	19.80	19.92	20.10
L1			4.30
P	3.50	3.60	3.70
Q	5.60		6.00
S	6.05	6.15	6.25

5 Revision history

Table 9. Document revision history

Date	Revision	Changes
28-Feb-2014	1	Initial release.
31-Mar-2014	2	Document status changed from preliminary to production data. Updated Table 4: Static characteristics and Table 6: Switching characteristics (inductive load) . Added Section 2.1: Electrical characteristics (curves) .
06-Mar-2015	3	Added 4.2: TO-247 long leads, package information Updated Features and Figure 23.: Gate charge test circuit Minor text changes
23-Mar-2015	4	Removed figures with diode Minor text changes.

IMPORTANT NOTICE – PLEASE READ CAREFULLY

STMicroelectronics NV and its subsidiaries ("ST") reserve the right to make changes, corrections, enhancements, modifications, and improvements to ST products and/or to this document at any time without notice. Purchasers should obtain the latest relevant information on ST products before placing orders. ST products are sold pursuant to ST's terms and conditions of sale in place at the time of order acknowledgement.

Purchasers are solely responsible for the choice, selection, and use of ST products and ST assumes no liability for application assistance or the design of Purchasers' products.

No license, express or implied, to any intellectual property right is granted by ST herein.

Resale of ST products with provisions different from the information set forth herein shall void any warranty granted by ST for such product.

ST and the ST logo are trademarks of ST. All other product or service names are the property of their respective owners.

Information in this document supersedes and replaces information previously supplied in any prior versions of this document.

© 2015 STMicroelectronics – All rights reserved