

**SF2038B-2**

**76.500 MHz  
SAW Filter**

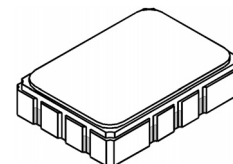

**SMP-03**

- *Designed for SDARS IF Receiver*
- *Low Insertion Loss*
- *5.0 X 7.0 mm Surface-Mount Case*
- *Differential or Single Ended Input and Output*
- *Complies with Directive 2002/95/EC (RoHS)*
- *Moisture Sensitivity Level: 1*
- *AEC-Q200 Qualified*

**Absolute Maximum Ratings**

Rating	Value	Units
Maximum Incident Power in Passband	+10	dBm
Max. DC voltage between any 2 terminals	30	VDC
Storage Temperature Range (with tape & reel)	-40 to +85	°C
Storage Temperature Range (without tape & reel)	-50 to +125	°C
Max Soldering Profile	265°C for 10 s	

**Electrical Characteristics**

Characteristic	Sym	Notes	Min	Typ	Max	Units			
Nominal Center Frequency	$f_C$			76.500		MHz			
Passband	Insertion Loss	IL		10.0	12.0	dB			
			1dB Passband	BW <sub>1</sub>	12.5		14.0	MHz	
			15dB Bandwidth	BW <sub>15</sub>			16.8	18.0	MHz
			30dB Bandwidth	BW <sub>30</sub>			18.0	19.2	MHz
Amplitude Ripple over $f_c \pm 6.25$ MHz				0.70	1.3	dB <sub>p-p</sub>			
Group Delay Variation over $f_c \pm 6.25$ MHz		GDV		40	150	ns <sub>p-p</sub>			
Rejection	50 to 64.44 MHz		40	46	dB				
			64.44 to 66.70 MHz -40 to 85°C	36		41			
			64.44 to 66.70 MHz 85 to 105°C	30					
			86.30 to 87.54 MHz	*30		44			
			87.54 to 91.50 MHz	31		44			
			91.50 to 100 MHz	40		47			
Operating Temperature Range	T <sub>A</sub>		-40		+105	°C			
Frequency Coefficient	FTC			-87		ppm/°C			
Differential Input				175 ohms					
Differential Output				180 ohms					
Case Style				SMP-03 7 x 5 mm Nominal Footprint					
Lid Symbolization (YY=year, WW=week, S=shift, ## = Sequence code)				RFM, SF2038B, YYWWS##					

\*At low temperature extreme -40°C



**CAUTION: Electrostatic Sensitive Device. Observe precautions for handling.**

**NOTES:**

1. The design, manufacturing process, and specifications of this device are subject to change.
2. US or International patents may apply.
3. RoHS compliant from the first date of manufacture.

## Matching Circuit and Matching Component Values Used in G3 Sirius Radios

(Refer to Sirius Radio G3 Chipset Application Note, Doc. #RX000104-B, Sec. 4.2.2)

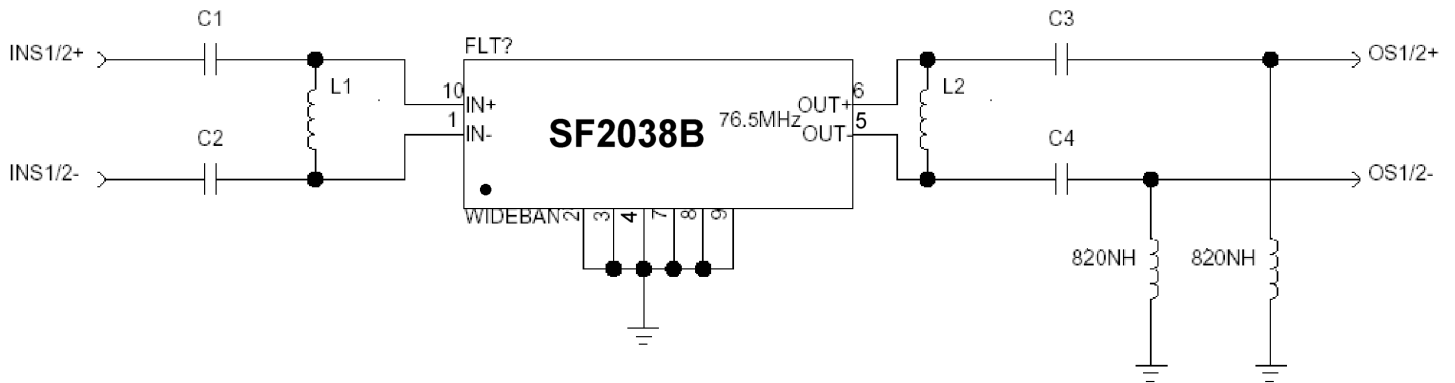

**Wideband SAW Matching Circuit**

### Wideband SAW Matching Values

Reference Designator	Value
C1	15 pF
C2	15 pF
L1	270 nH
L2	270 nH
C3	27 pF
C4	27 pF

**Matching Circuit and Matching Component Values Used on Filter Demo Board**

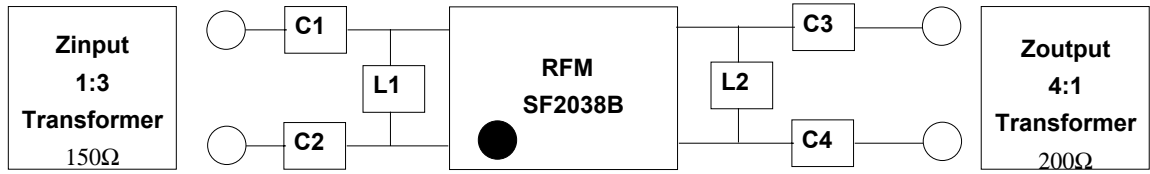

**SF2038B**  
**76.500 MHz**

**C1 = 22pF**  
**C2 = 22pF**  
**L1 = 220nH**  
**L2 = 270nH**  
**C3 = 22pF**  
**C4 = 22pF**

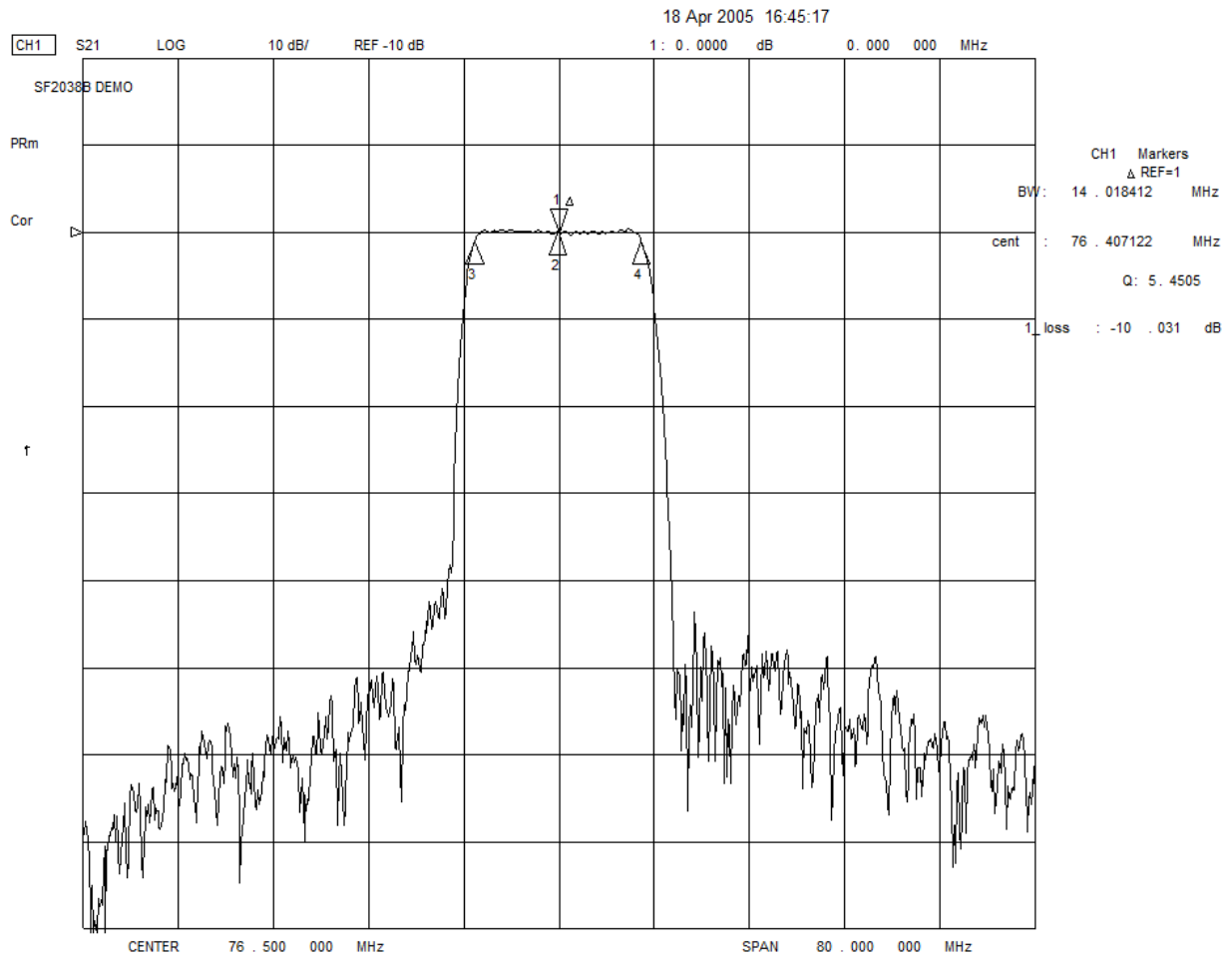

18 Apr 2005 16:42:05

CH1 S21 LOG 1 dB/ REF -10.4 dB 2 :- . 29950 dB 12 . 722 641 MHz

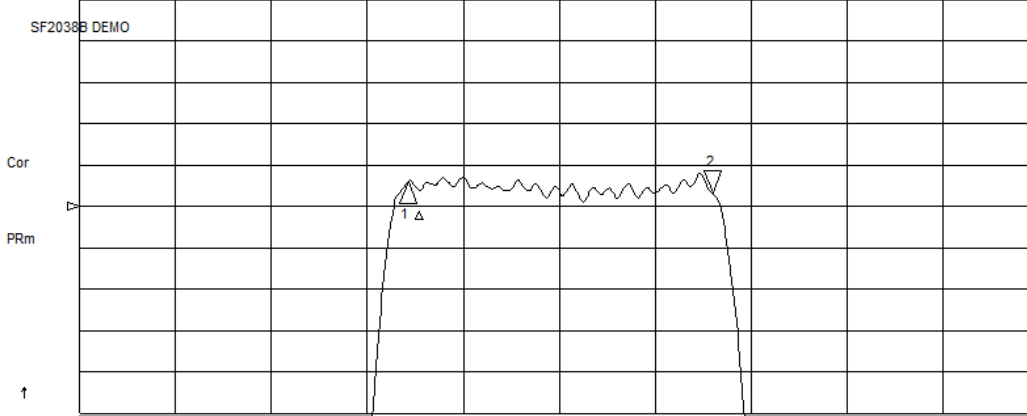

CH1 Markers  
Δ REF=1  
mean : -9 . 9489 dB  
s. dev : . 13250 dB  
p-p : . 69240 dB

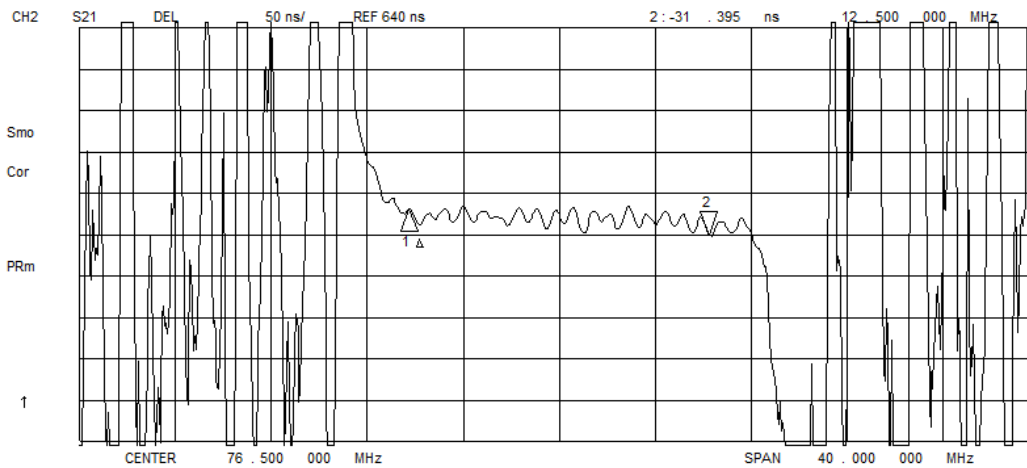

CH2 Markers  
Δ REF=1  
mean : 659 . 90 ns  
s. dev : 7 . 6786 ns  
p-p : 35 . 477 ns

18 Apr 2005 16:35:10

CH1 S11 1 UFS

1 : 44 . 537 Ω 19 . 910 Ω 41 . 422 nH 76 . 500 000 MHz

SF2038B DEMO

Cor

PRm

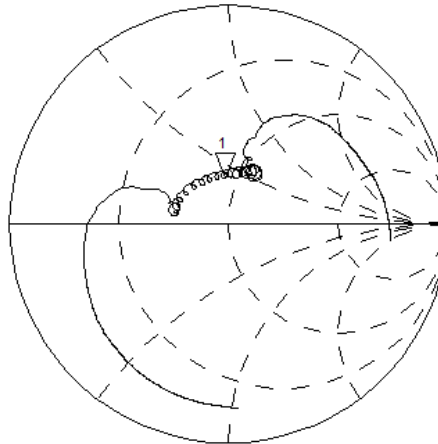

CH2 S22 1 UFS

1 : 53 . 521 Ω 19 . 055 Ω 39 . 642 nH 76 . 500 000 MHz

Cor

PRm

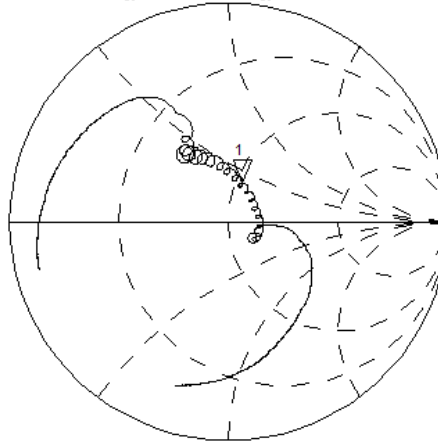

CENTER 76 . 500 000 MHz

SPAN 40 . 000 000 MHz

# SMP-03 Case

## 10-Terminal Ceramic Surface-Mount Case 7 x 5 mm Nominal Footprint

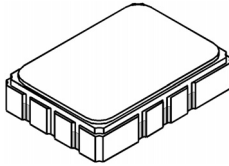

Recommended PCB Footprint

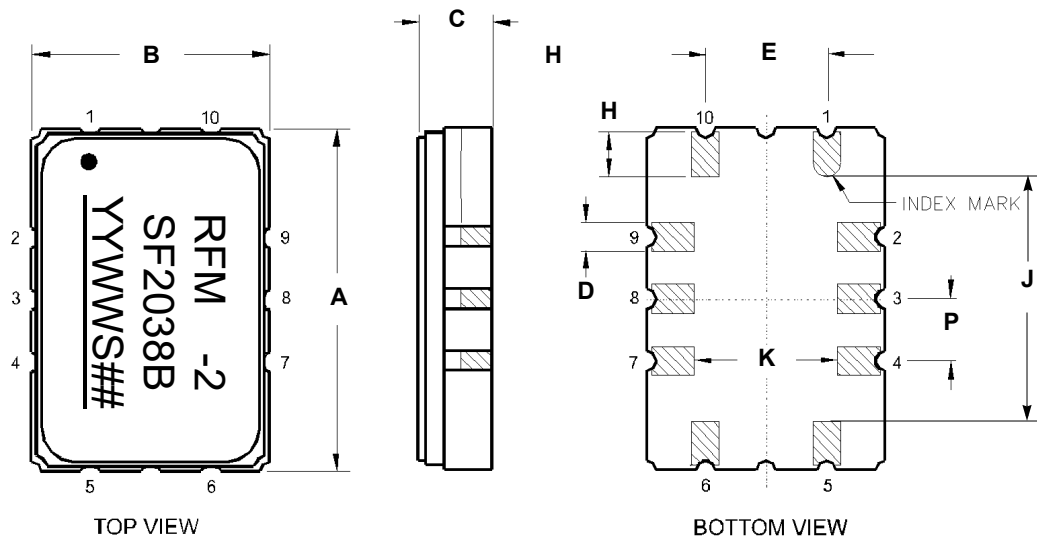
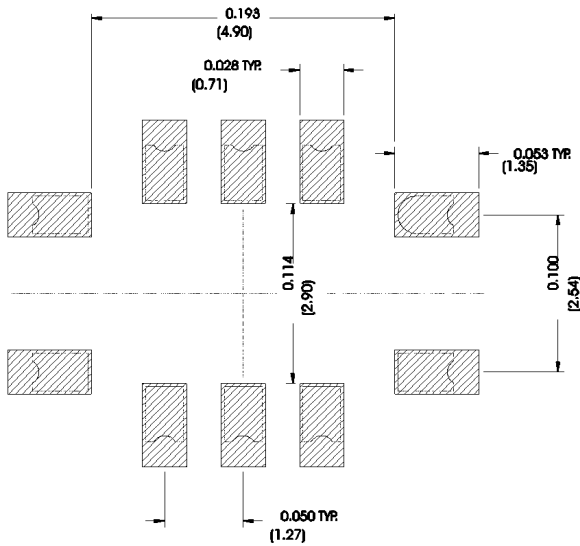

Case Dimensions						
Dimension	mm			Inches		
	Min	Nom	Max	Min	Nom	Max
A	6.80	7.00	7.20	0.268	0.276	0.283
B	4.80	5.00	5.20	0.189	0.197	0.205
C		1.65	2.00		0.065	0.079
D	.47	0.60	.73	0.019	0.024	0.029
E	2.41	2.54	2.67	0.095	0.100	0.105
H	0.87	1.0	1.13	0.034	0.039	0.044
J	4.87	5.00	5.13	0.192	0.197	0.202
K	2.87	3.00	3.13	0.113	0.118	0.123
P	1.14	1.27	1.40	0.045	0.050	0.055

Materials	
Solder Pad Termination	Au plating 30 - 60 ulnches (76.2-152 uM) over 80-200 ulnches (203-508 uM) Ni.
Lid	Fe-Ni-Co Alloy Electroless Nickel Plate (8-11% Phosphorus) 100-200 ulnches Thick
Body	Al <sub>2</sub> O <sub>3</sub> Ceramic

Electrical Connections		
	Connection	Terminals
Port 1	Input or Return	10
	Return or Input	1
Port 2	Output or Return	5
	Return or Output	6
	Ground	All others
	Single Ended Operation	Return is ground
	Differential Operation	Return is hot

## Tape and Reel Specifications

Tape and Reel Standard per ANSI/EIA-481

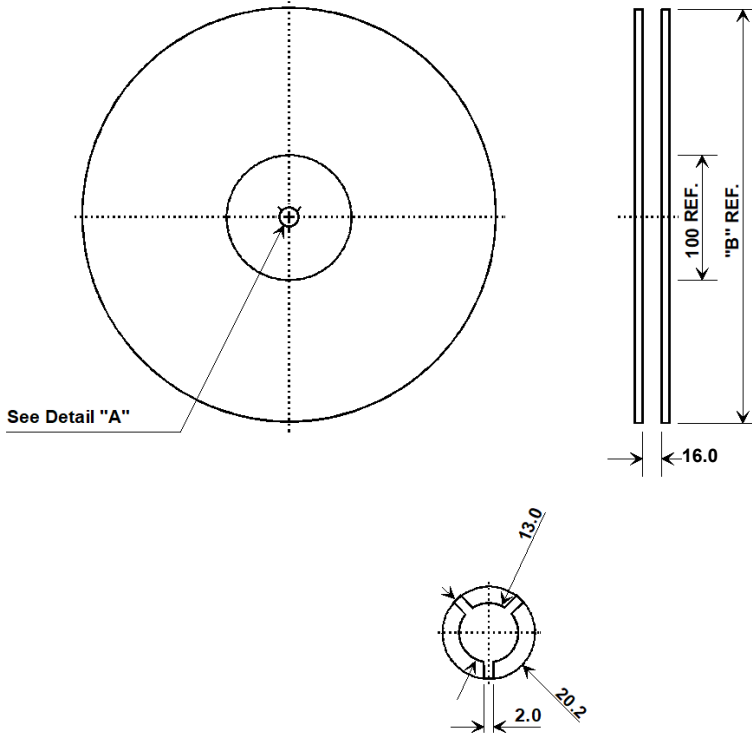

"B"		Quantity Per Reel
Inches	millimeters	
7	178	500
13	330	2000

### Product Reflow/ESD/MSL

Reflow Peak Temperature	265	°C
Reflow Peak Time	10	Seconds
Liquidus 217 Temperature/Time	110	Seconds
Over Liquidus 230 Temperature/Time	70	Seconds
Reflow Condition	SMT	
Class Level HBM	2	
HBM(V)	2000	HBM(V)
MM(V)	N/A	MM(V)
CDM(V)	2000	CDM(V)

### COMPONENT ORIENTATION and DIMENSIONS

Carrier Tape Dimensions	
Ao	5.5 mm
Bo	7.5 mm
Ko	2.0 mm
Pitch	8.0 mm
W	16.0 mm

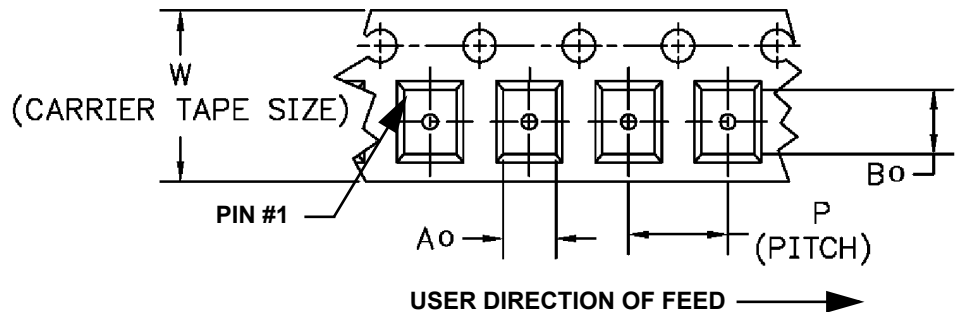
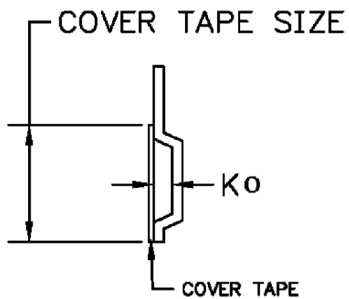

## Recommended Reflow Profile

1. Preheating shall be fixed at 150~180°C for 60~90 seconds.
2. Ascending time to preheating temperature 150°C shall be 30 seconds min.
3. Heating shall be fixed at 220°C for 50~80 seconds and at 260°C+0/-5°C peak (10 seconds).
4. Time: 5 times maximum.

