

AOT460

N-Channel Enhancement Mode Field Effect Transistor

General Description

The AOT460/L uses advanced trench technology and design to provide excellent $R_{DS(ON)}$ with low gate charge. This device is suitable for use in UPS, high current switching applications. AOT460 and AOT460L are electrically identical.

- RoHS Compliant
- Halogen Free

Features

$V_{DS} (V) = 60V$
 $I_D = 85 A$ ($V_{GS} = 10V$)
 $R_{DS(ON)} < 7.5m\Omega$ ($V_{GS} = 10V$)

100% UIS Tested!

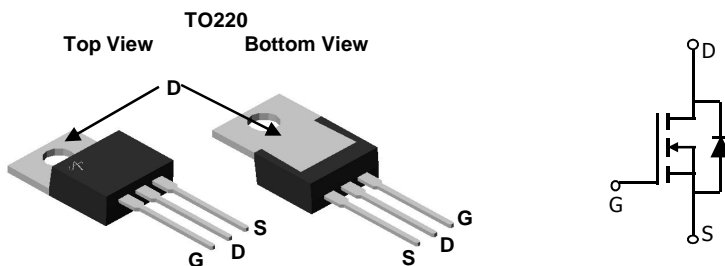

Absolute Maximum Ratings $T_A=25^\circ C$ unless otherwise noted

Parameter	Symbol	Maximum	Units
Drain-Source Voltage	V_{DS}	60	V
Gate-Source Voltage	V_{GS}	± 20	V
Continuous Drain Current ^C	I_D	$T_C=25^\circ C$	A
		$T_C=100^\circ C$	
Pulsed Drain Current ^C	I_{DM}	340	A
Avalanche Current ^C	I_{AR}	80	A
Repetitive avalanche energy $L=0.1mH$ ^C	E_{AR}	320	mJ
Power Dissipation ^B	P_D	$T_C=25^\circ C$	W
		$T_C=100^\circ C$	
Junction and Storage Temperature Range	T_J, T_{STG}	-55 to 175	$^\circ C$

Thermal Characteristics

Parameter	Symbol	Typ	Max	Units
Maximum Junction-to-Ambient ^A	$R_{\theta JA}$	45	60	$^\circ C/W$
Maximum Junction-to-Case ^B	$R_{\theta JC}$	0.45	0.56	$^\circ C/W$

Electrical Characteristics ($T_J=25^\circ\text{C}$ unless otherwise noted)

Symbol	Parameter	Conditions	Min	Typ	Max	Units
STATIC PARAMETERS						
BV_{DSS}	Drain-Source Breakdown Voltage	$I_D=250\mu\text{A}$, $V_{GS}=0\text{V}$	60			V
I_{DSS}	Zero Gate Voltage Drain Current	$V_{DS}=60\text{V}$, $V_{GS}=0\text{V}$ $T_J=55^\circ\text{C}$			10 50	μA
I_{GSS}	Gate-Body leakage current	$V_{DS}=0\text{V}$, $V_{GS}=\pm 20\text{V}$			100	nA
$V_{GS(th)}$	Gate Threshold Voltage	$V_{DS}=V_{GS}$, $I_D=250\mu\text{A}$	2	2.95	4	V
$I_{D(ON)}$	On state drain current	$V_{GS}=10\text{V}$, $V_{DS}=5\text{V}$	340			A
$R_{DS(ON)}$	Static Drain-Source On-Resistance	$V_{GS}=10\text{V}$, $I_D=30\text{A}$ $T_J=125^\circ\text{C}$		6.3 10.5	7.5 13	$\text{m}\Omega$
g_{FS}	Transconductance	$V_{DS}=5\text{V}$, $I_D=30\text{A}$		90		S
V_{SD}	Diode Forward Voltage	$I_S=1\text{A}$, $V_{GS}=0\text{V}$		0.7	1	V
I_S	Maximum Body-Diode Continuous Current ^G				85	A
DYNAMIC PARAMETERS						
C_{iss}	Input Capacitance	$V_{GS}=0\text{V}$, $V_{DS}=30\text{V}$, $f=1\text{MHz}$		3800	4560	pF
C_{oss}	Output Capacitance			430		pF
C_{rss}	Reverse Transfer Capacitance			190		pF
R_g	Gate resistance	$V_{GS}=0\text{V}$, $V_{DS}=0\text{V}$, $f=1\text{MHz}$		1.5	2.3	Ω
SWITCHING PARAMETERS						
$Q_g(10\text{V})$	Total Gate Charge	$V_{GS}=10\text{V}$, $V_{DS}=30\text{V}$, $I_D=30\text{A}$		68	88	nC
$Q_g(4.5\text{V})$	Total Gate Charge			33		nC
Q_{gs}	Gate Source Charge			15		nC
Q_{gd}	Gate Drain Charge			19		nC
$t_{D(on)}$	Turn-On DelayTime	$V_{GS}=10\text{V}$, $V_{DS}=30\text{V}$, $R_L=1\Omega$, $R_{GEN}=3\Omega$		18		ns
t_r	Turn-On Rise Time			35		ns
$t_{D(off)}$	Turn-Off DelayTime			44		ns
t_f	Turn-Off Fall Time			23		ns
t_{rr}	Body Diode Reverse Recovery Time	$I_F=30\text{A}$, $di/dt=100\text{A}/\mu\text{s}$		53	64	ns
Q_{rr}	Body Diode Reverse Recovery Charge	$I_F=30\text{A}$, $di/dt=100\text{A}/\mu\text{s}$		98		nC

A: The value of $R_{\theta JA}$ is measured with the device in a still air environment with $T_A=25^\circ\text{C}$.

B: The power dissipation P_D is based on $T_{J(MAX)}=175^\circ\text{C}$, using junction-to-case thermal resistance, and is more useful in setting the upper dissipation limit for cases where additional heatsinking is used.

C: Repetitive rating, pulse width limited by junction temperature $T_{J(MAX)}=175^\circ\text{C}$.

D: The $R_{\theta JA}$ is the sum of the thermal impedance from junction to case $R_{\theta JC}$ and case to ambient.

E: The static characteristics in Figures 1 to 6 are obtained using $<300\mu\text{s}$ pulses, duty cycle 0.5% max.

F: These curves are based on the junction-to-case thermal impedance which is measured with the device mounted to a large heatsink, assuming a maximum junction temperature of $T_{J(MAX)}=175^\circ\text{C}$.

G: The maximum current rating is limited by bond-wires.

Rev1: Jan. 2009

THIS PRODUCT HAS BEEN DESIGNED AND QUALIFIED FOR THE CONSUMER MARKET. APPLICATIONS OR USES AS CRITICAL COMPONENTS IN LIFE SUPPORT DEVICES OR SYSTEMS ARE NOT AUTHORIZED. AOS DOES NOT ASSUME ANY LIABILITY ARISING OUT OF SUCH APPLICATIONS OR USES OF ITS PRODUCTS. AOS RESERVES THE RIGHT TO IMPROVE PRODUCT DESIGN, FUNCTIONS AND RELIABILITY WITHOUT NOTICE.

TYPICAL ELECTRICAL AND THERMAL CHARACTERISTICS

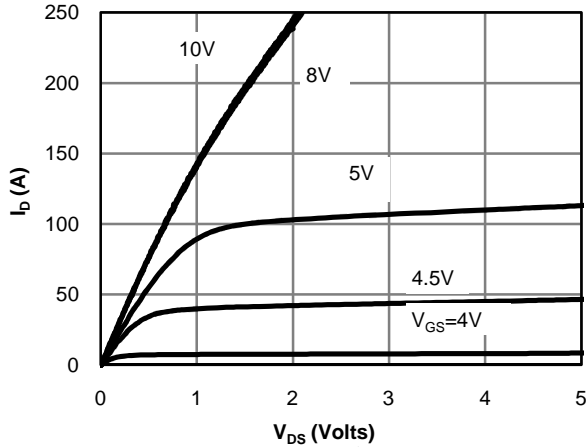

Figure 1: On-Region Characteristics

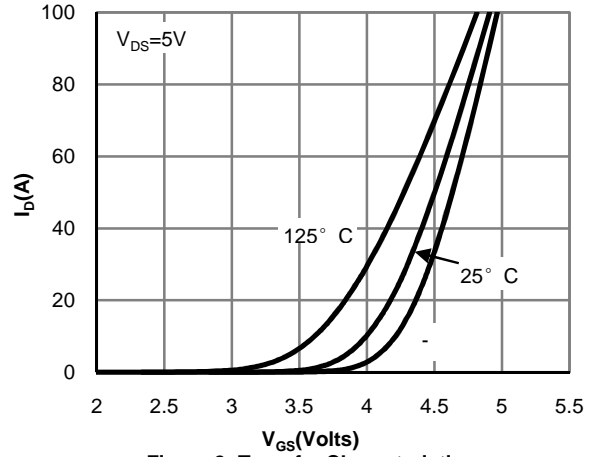

Figure 2: Transfer Characteristics

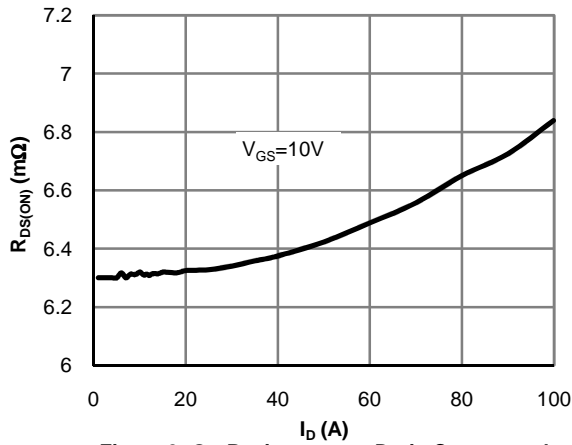

Figure 3: On-Resistance vs. Drain Current and Gate Voltage

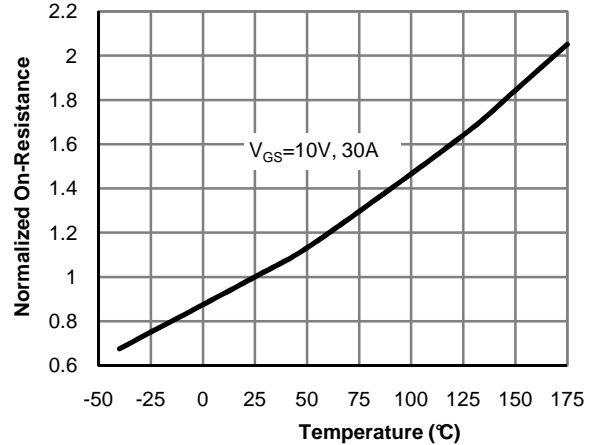

Figure 4: On-Resistance vs. Junction Temperature

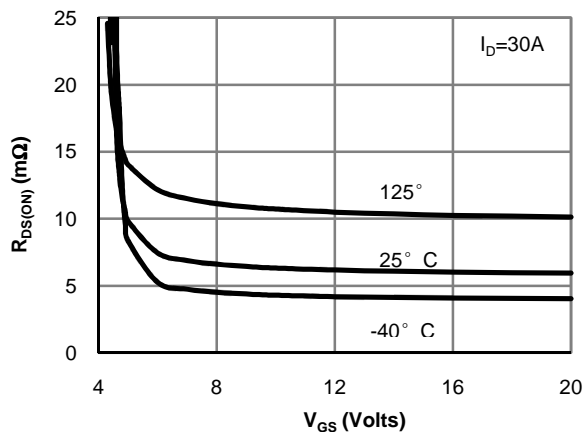

Figure 5: On-Resistance vs. Gate-Source Voltage

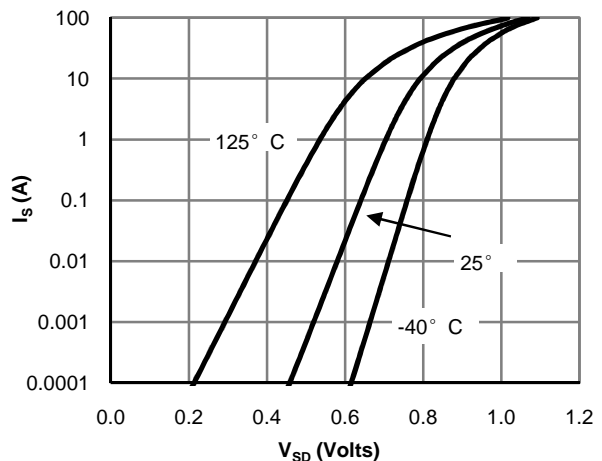

Figure 6: Body-Diode Characteristics

TYPICAL ELECTRICAL AND THERMAL CHARACTERISTICS

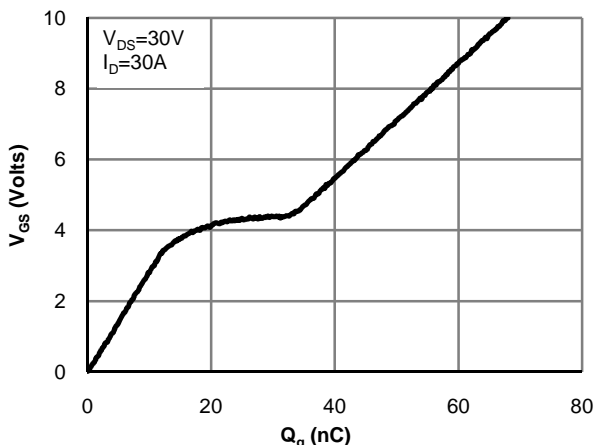

Figure 7: Gate-Charge Characteristics

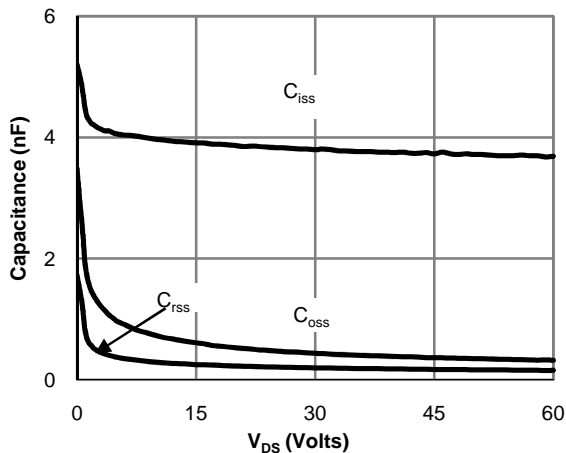

Figure 8: Capacitance Characteristics

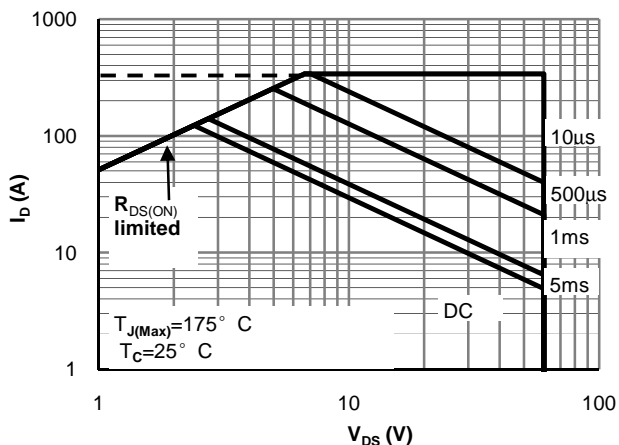

Figure 9: Maximum Forward Biased Safe Operating Area (Note F)

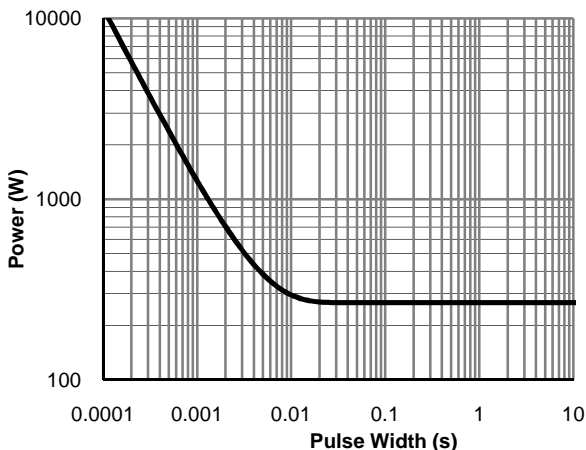

Figure 10: Single Pulse Power Rating Junction-to-Case (Note F)

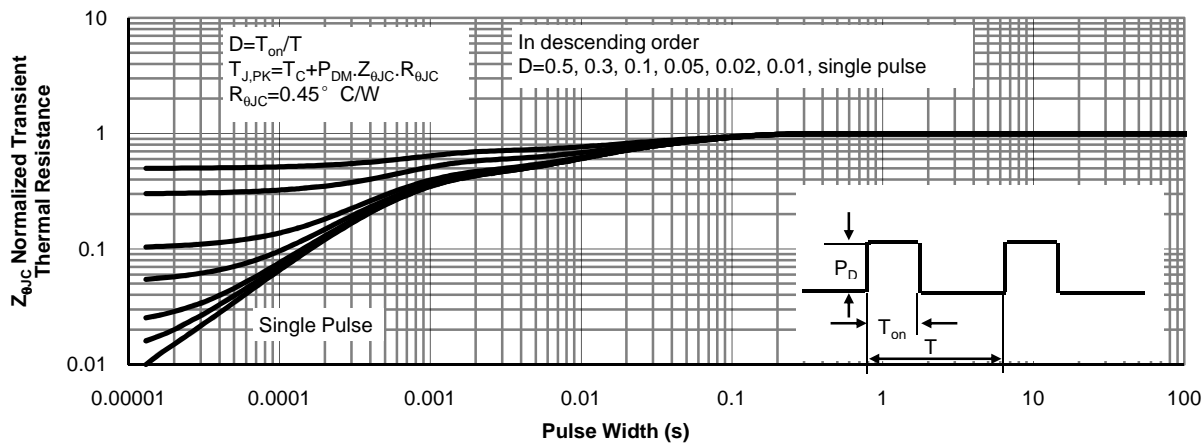

Figure 11: Normalized Maximum Transient Thermal Impedance (Note F)

TYPICAL ELECTRICAL AND THERMAL CHARACTERISTICS

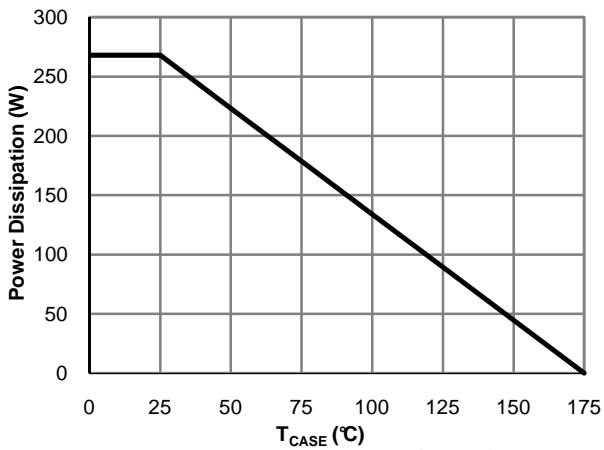

Figure 13: Power De-rating (Note B)

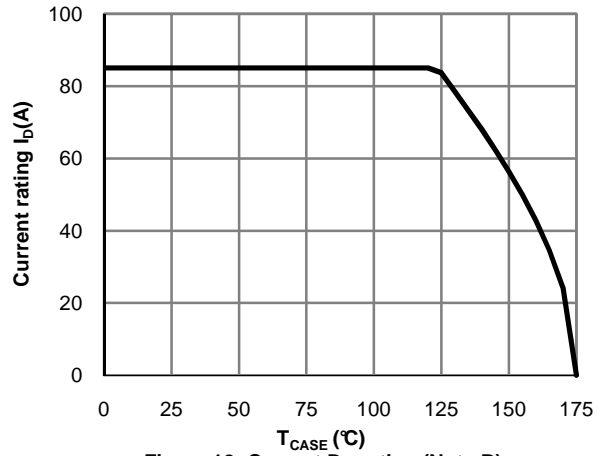

Figure 12: Current De-rating (Note B)

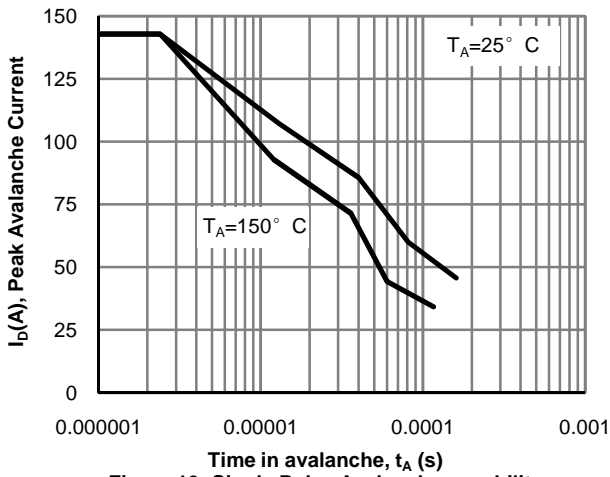
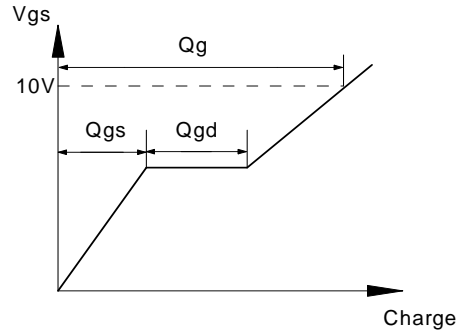
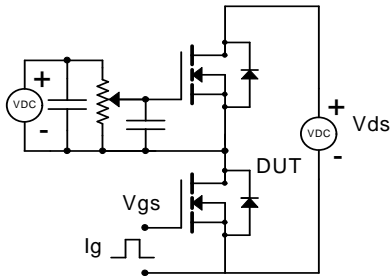
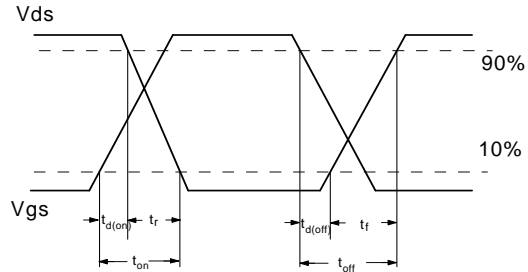
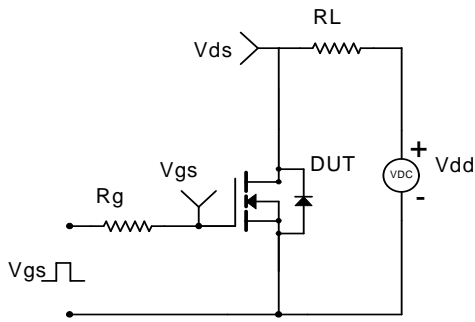

Figure 10: Single Pulse Avalanche capability

Gate Charge Test Circuit & Waveform



Resistive Switching Test Circuit & Waveforms



Unclamped Inductive Switching (UIS) Test Circuit & Waveforms

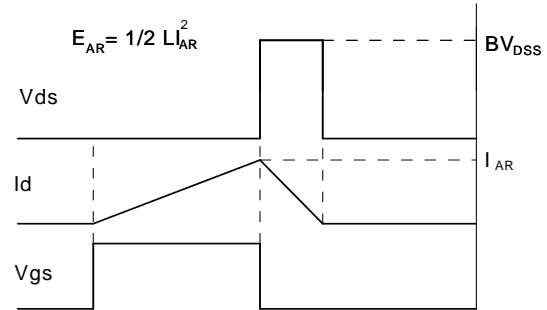
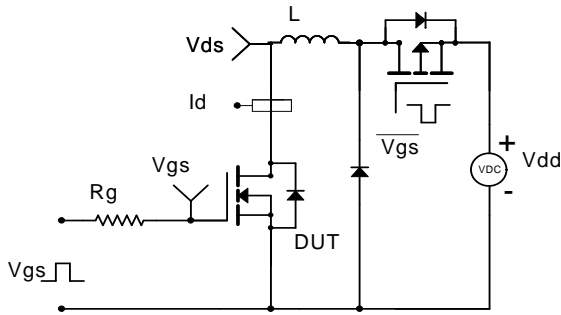

Diode Recovery Test Circuit & Waveforms

