

FODM3011, FODM3012, FODM3022, FODM3023, FODM3052, FODM3053

4-Pin Full Pitch Mini-Flat Package Random-Phase Triac Driver Output Optocouplers

Features

- Compact 4-pin surface mount package (2.4 mm maximum standoff height)
- Peak blocking voltage
250V (FODM301X)
400V (FODM302X)
600V (FODM305X)
- Available in tape and reel quantities of 500 and 2500.
- Add "NF098" for new construction version with 260°C max. reflow temperature rating
- UL, C-UL and VDE certifications pending

Applications

- Industrial controls
- Traffic lights
- Vending machines

Applications (Continued)

- Solid state relay
- Lamp ballasts
- Solenoid/valve controls
- Static AC power switch
- Incandescent lamp dimmers
- Motor control

Description

The FODM301X, FODM302X, and FODM305X series consists of a GaAs infrared emitting diode driving a silicon bilateral switch housed in a compact 4-pin mini-flat package. The lead pitch is 2.54mm. They are designed for interfacing between electronic controls and power triacs to control resistive and inductive loads for 115V/240V operations.

Package Dimensions

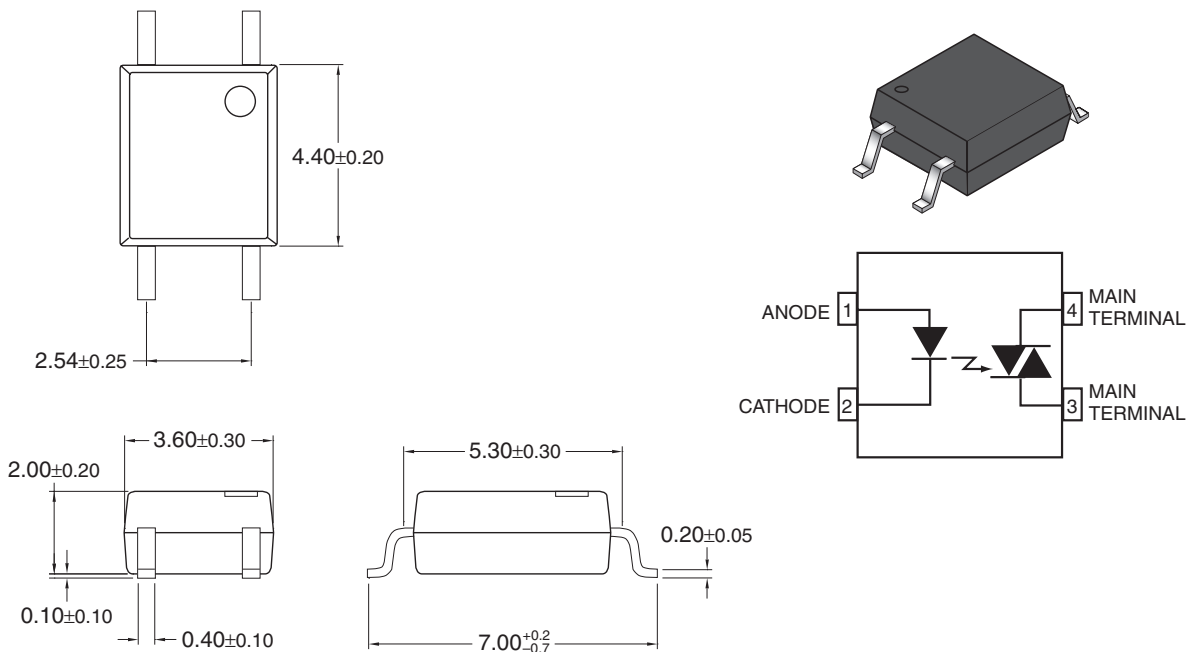

Note:

All dimensions are in millimeters.

Absolute Maximum Ratings ($T_A = 25^\circ\text{C}$ unless otherwise specified)

Symbol	Parameter	Value	Units
TOTAL PACKAGE			
T_{STG}	Storage Temperature	-55 to +150	$^\circ\text{C}$
T_{OPR}	Operating Temperature	-40 to +100	$^\circ\text{C}$
EMITTER			
I_F (avg)	Continuous Forward Current	60	mA
I_F (pk)	Peak Forward Current (1 μs pulse, 300pps.)	1	A
V_R	Reverse Input Voltage	3	V
P_D	Power Dissipation (No derating required over operating temp. range)	100	mW
DETECTOR			
$I_{T(RMS)}$	On-State RMS Current	70	mA (RMS)
V_{DRM}	Off-State Output Terminal Voltage	FODM3011/FODM3012	250
		FODM3022/FODM3023	400
		FODM3052/FODM3053	600
P_D	Power Dissipation (No derating required over operating temp. range)	300	mW

Electrical Characteristics ($T_A = 25^\circ\text{C}$)**Individual Component Characteristics**

Symbol	Parameter	Test Conditions	Device	Min.	Typ.*	Max.	Unit
EMITTER							
V_F	Input Forward Voltage	$I_F = 10\text{mA}$	All		1.20	1.5	V
I_R	Reverse Leakage Current	$V_R = 3\text{V}, T_A = 25^\circ\text{C}$	All		0.01	100	μA
DETECTOR							
I_{DRM}	Peak Blocking Current Either Direction	Rated $V_{\text{DRM}}, I_F = 0^{(1)}$	All		2	100	nA
dV/dt	Critical Rate of Rise of Off-State Voltage	$I_F = 0$ (Figure 8) ⁽²⁾	FODM3011, FODM3012, FODM3022, FODM3023		10		V/ μs
			FODM3052, FODM3053	1,000			

Transfer Characteristics ($T_A = 25^\circ\text{C}$)

Symbol	DC Characteristics	Test Conditions	Device	Min.	Typ.*	Max.	Unit
I_{FT}	LED Trigger Current	Main Terminal Voltage = $3\text{V}^{(3)}$	FODM3011, FODM3022, FODM3052			10	mA
			FODM3012, FODM3023, FODM3053			5	
I_H	Holding Current, Either Direction		All		300		μA
V_{TM}	Peak On-State Voltage Either Direction	$I_{\text{TM}} = 100\text{mA}$ peak	All		1.7	3	V

Isolation Characteristics

Symbol	Characteristic	Test Conditions	Device	Min.	Typ.*	Max.	Unit
V_{ISO}	Steady State Isolation Voltage	1 Minute, R.H. = 40% to 60%	All	3750			VRMS

*All typicals at $T_A = 25^\circ\text{C}$ **Notes:**

1. Test voltage must be applied within dv/dt rating.
2. This is static dv/dt. See Figure 1 for test circuit. Commutating dv/dt is function of the load-driving thyristor(s) only.
3. All devices are guaranteed to trigger at an I_F value less than or equal to max I_{FT} . Therefore, recommended operating I_F lies between max I_{FT} (10mA for FODM3011, FODM3022, and FODM3052, 5mA for FODM3012, FODM3023, and FODM3053) and absolute max I_F (60mA).

Typical Performance Curves

Fig. 1 LED Forward Voltage vs. Forward Current

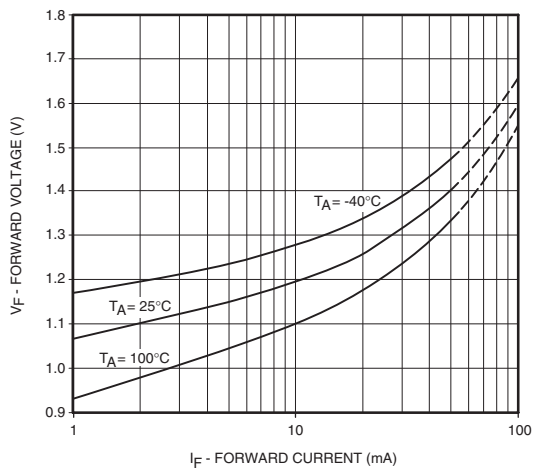

Fig. 2 Leakage Current vs. Ambient Temperature

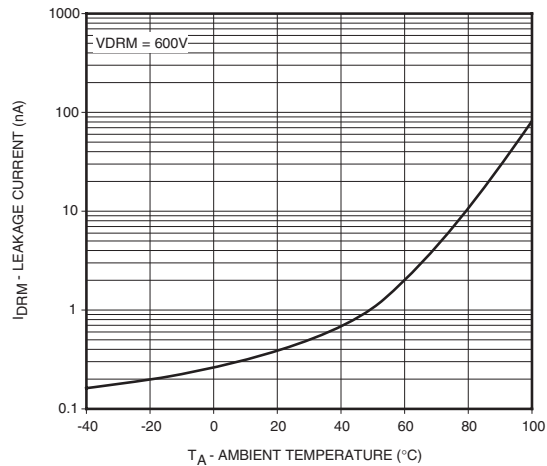

Fig. 3 Holding Current vs. Ambient Temperature

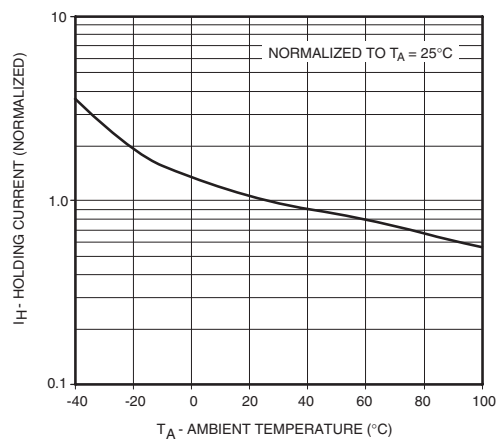
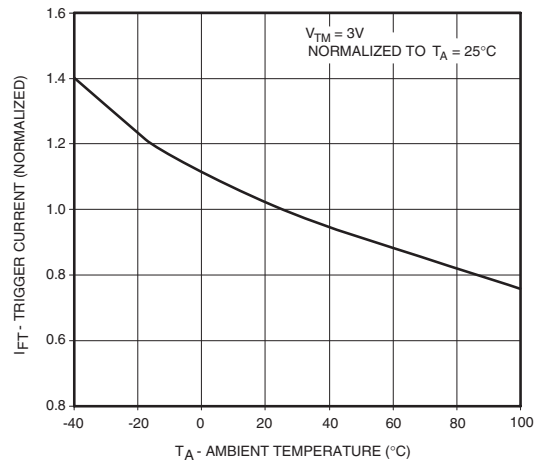

Fig. 4 Trigger Current vs. Ambient Temperature



Typical Performance Curves

Fig. 5 LED Current Required to Trigger vs. LED Pulse Width

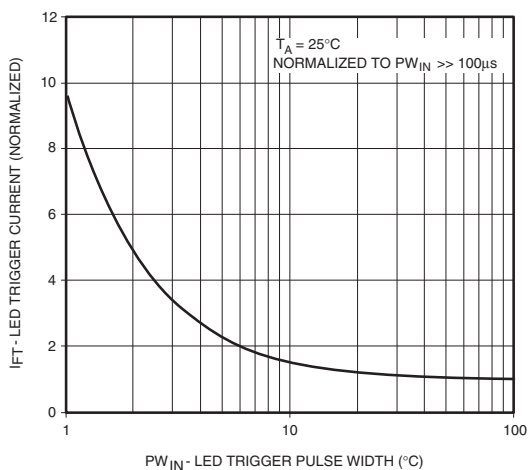

Fig. 6 Off-State Output Terminal Voltage vs. Ambient Temperature

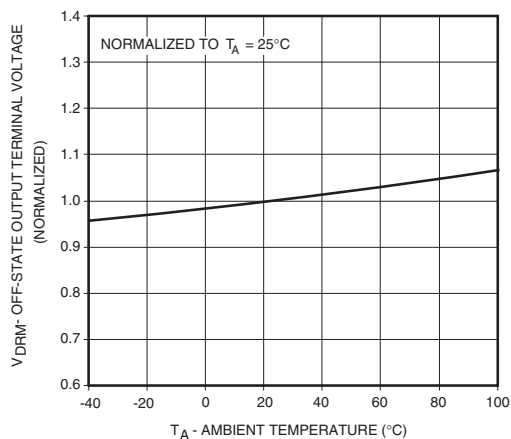
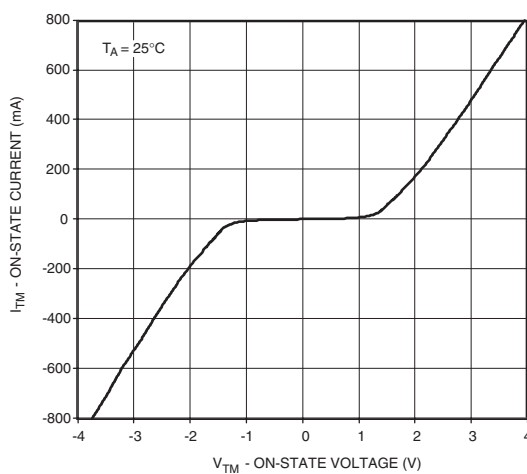

Fig. 7 On-State Characteristics



Typical Performance Curves

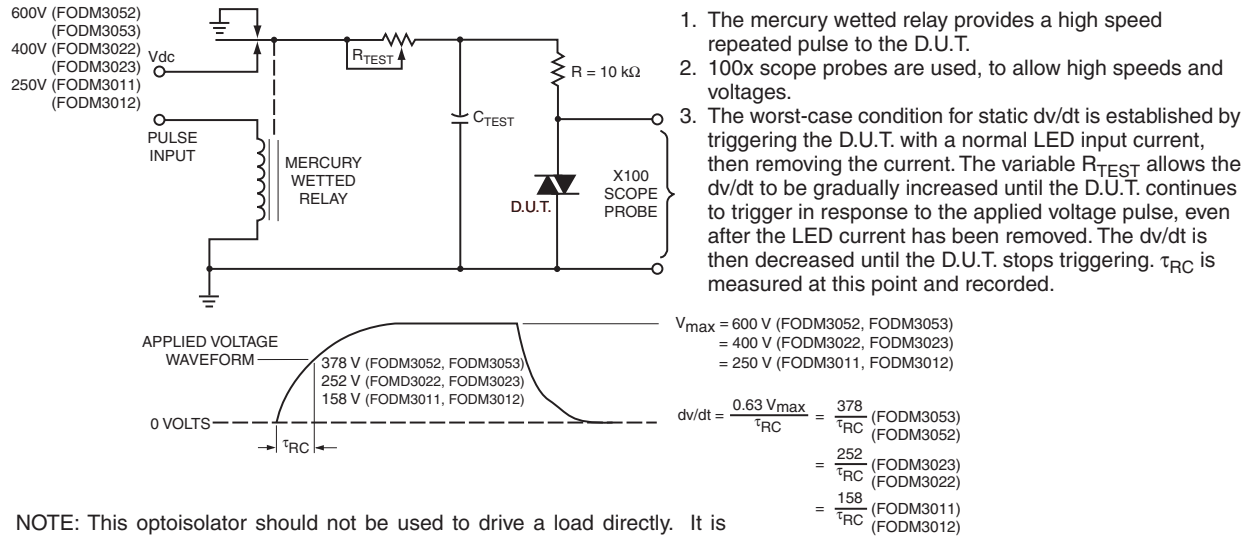

Figure 8. Static dv/dt Test Circuit

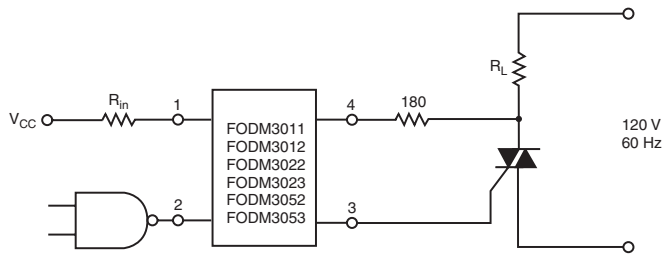

Figure 9. Resistive Load

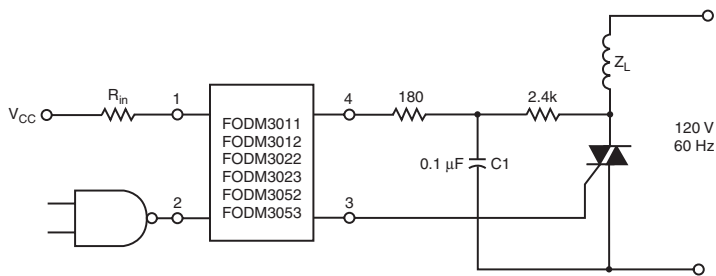
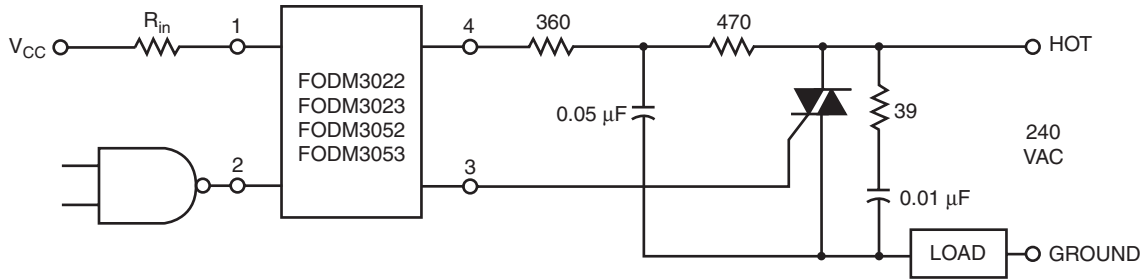

Figure 10. Inductive Load with Sensitive Gate Triac (I_{GT} ≤ 15 mA)



In this circuit the “hot” side of the line is switched and the load connected to the cold or ground side.
 The 39Ω resistor and 0.01μF capacitor are for snubbing of the triac, and the 470Ω resistor and 0.05μF capacitor are for snubbing the coupler. These components may or may not be necessary depending upon the particular and load used.

Figure 11. Typical Application Circuit

Ordering Information

Option	Description
V_NF098	VDE Approved
R1_NF098	Tape and Reel (500 units)
R2_NF098	Tape and Reel (2500 units)
R1V_NF098	Tape and Reel (500 units) and VDE Approved
R2V_NF098	Tape and Reel (2500 units) and VDE Approved

Note:

To specify the new construction version with 260°C max reflow peak temperature rating: Add "NF098" to the end of the part number. The non NF098 version is rated for 230°C peak reflow temperature.

Marking Information

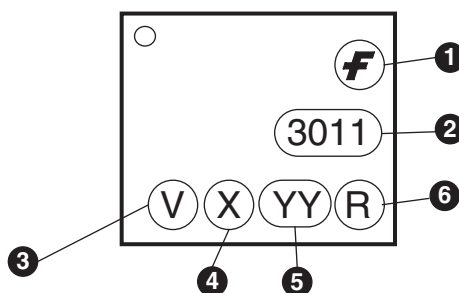

Definitions	
1	Fairchild logo
2	Device number
3	VDE mark (Note: Only appears on parts ordered with VDE option – See order entry table)
4	One digit year code
5	Two digit work week ranging from '01' to '53'
6	Assembly package code

Tape and Reel Information

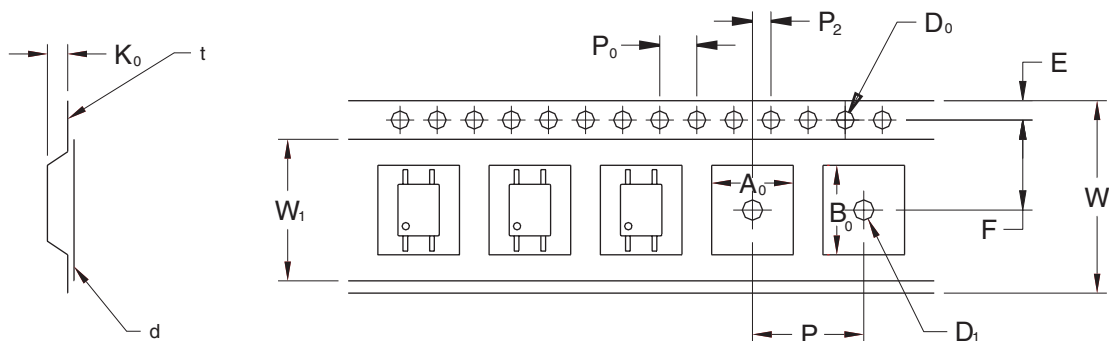

		2.54 Pitch
Description	Symbol	Dimensions
Tape Width	W	12.00±0.3
Tape Thickness	t	0.30±0.05
Sprocket Hole Pitch	P ₀	4.00±0.1
Sprocket Hole Dia.	D ₀	1.50±0.1
Sprocket Hole Location	E	1.75±0.1
Pocket Location	F	5.50±0.1
	P ₂	2.00±0.1
Pocket Pitch	P	8.00±0.1
Pocket Dimension	A ₀	3.90±0.1
	B ₀	7.45±0.1
	K ₀	2.45±0.1
Pocket Hole Dia.	D ₁	1.50±0.1
Cover Tape Width	W ₁	9.30±0.1
Cover Tape Thickness	d	0.062±0.02
Max. Component Rotation or Tilt		20° max
Devices Per Reel	R1	500
	R2	2500
Reel Diameter	R1	178 mm (7")
	R2	330 mm (13")

Footprint Drawing for PCB Layout

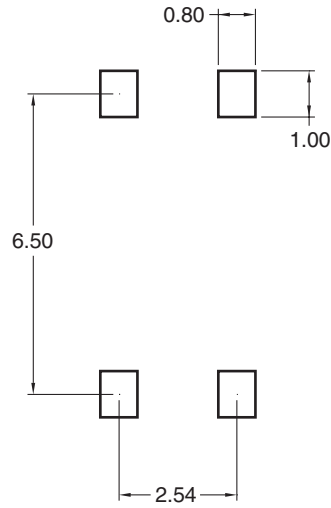

Note:
All dimensions are in mm.

Recommended Infrared Reflow Soldering Profile

- Peak reflow temperature: 260°C (package surface temperature)
- Time of temperature higher than 245°C: 40 seconds or less
- Number of reflows: 3

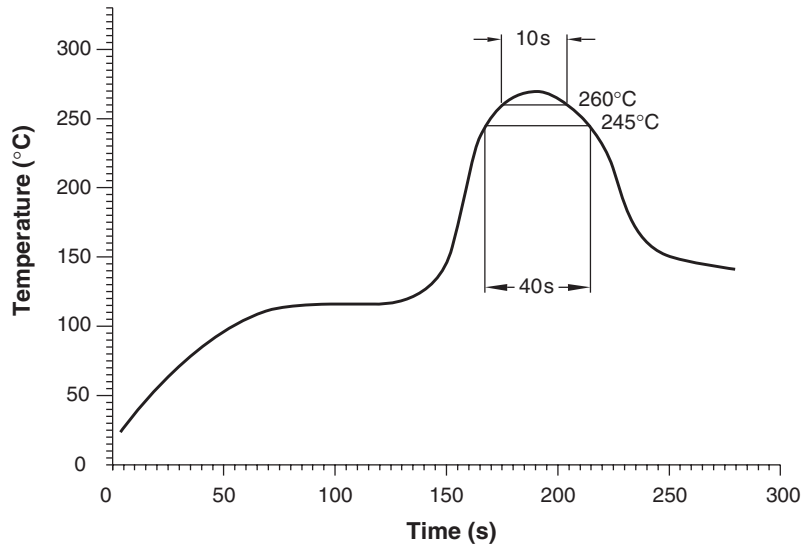



TRADEMARKS

The following are registered and unregistered trademarks and service marks Fairchild Semiconductor owns or is authorized to use and is not intended to be an exhaustive list of all such trademarks.

ACEx®	Green FPS™ e-Series™	POWEREDGE®	SuperSOT™-8
Build it Now™	GTO™	Power-SPM™	SyncFET™
CorePLUS™	<i>i-Lo</i> ™	PowerTrench®	The Power Franchise®
CROSSVOLT™	IntelliMAX™	Programmable Active Droop™	⏻™
CTL™	ISOPLANAR™	QFET®	TinyBoost™
Current Transfer Logic™	MegaBuck™	QS™	TinyBuck™
EcoSPARK®	MICROCOUPLER™	QT Optoelectronics™	TinyLogic®
FACT Quiet Series™	MicroFET™	Quiet Series™	TINYOPTO™
FACT®	MicroPak™	RapidConfigure™	TinyPower™
FAST®	Motion-SPM™	SMART START™	TinyPWM™
FastvCore™	OPTOLOGIC®	SPM®	TinyWire™
FPS™	OPTOPLANAR®	STEALTH™	SerDes™
FRFET®	PDP-SPM™	SuperFET™	UHC®
Global Power ResourceSM	Power220®	SuperSOT™-3	UniFET™
Green FPS™	Power247®	SuperSOT™-6	VCX™

DISCLAIMER

FAIRCHILD SEMICONDUCTOR RESERVES THE RIGHT TO MAKE CHANGES WITHOUT FURTHER NOTICE TO ANY PRODUCTS HEREIN TO IMPROVE RELIABILITY, FUNCTION, OR DESIGN. FAIRCHILD DOES NOT ASSUME ANY LIABILITY ARISING OUT OF THE APPLICATION OR USE OF ANY PRODUCT OR CIRCUIT DESCRIBED HEREIN; NEITHER DOES IT CONVEY ANY LICENSE UNDER ITS PATENT RIGHTS, NOR THE RIGHTS OF OTHERS. THESE SPECIFICATIONS DO NOT EXPAND THE TERMS OF FAIRCHILD'S WORLDWIDE TERMS AND CONDITIONS, SPECIFICALLY THE WARRANTY THEREIN, WHICH COVERS THESE PRODUCTS.

LIFE SUPPORT POLICY

FAIRCHILD'S PRODUCTS ARE NOT AUTHORIZED FOR USE AS CRITICAL COMPONENTS IN LIFE SUPPORT DEVICES OR SYSTEMS WITHOUT THE EXPRESS WRITTEN APPROVAL OF FAIRCHILD SEMICONDUCTOR CORPORATION.

As used herein:

1. Life support devices or systems are devices or systems which, (a) are intended for surgical implant into the body or (b) support or sustain life, and (c) whose failure to perform when properly used in accordance with instructions for use provided in the labeling, can be reasonably expected to result in a significant injury of the user.
2. A critical component in any component of a life support, device, or system whose failure to perform can be reasonably expected to cause the failure of the life support device or system, or to affect its safety or effectiveness.

PRODUCT STATUS DEFINITIONS

Definition of Terms

Datasheet Identification	Product Status	Definition
Advance Information	Formative or In Design	This datasheet contains the design specifications for product development. Specifications may change in any manner without notice.
Preliminary	First Production	This datasheet contains preliminary data; supplementary data will be published at a later date. Fairchild Semiconductor reserves the right to make changes at any time without notice to improve design.
No Identification Needed	Full Production	This datasheet contains final specifications. Fairchild Semiconductor reserves the right to make changes at any time without notice to improve design.
Obsolete	Not In Production	This datasheet contains specifications on a product that has been discontinued by Fairchild Semiconductor. The datasheet is printed for reference information only.

Rev. I29