



# Evaluation Board for the AD7795 16-Bit, Low Power Sigma-Delta ADC (6 Channels)

## EVAL-AD7795

### FEATURES

Full-featured evaluation board for the AD7795

Standalone USB interface

Various linking options

PC software for control of AD7795

### GENERAL DESCRIPTION

This data sheet describes the evaluation board for the AD7795, a low power, 16-bit  $\Sigma$ - $\Delta$  ADC. The AD7795 is a complete analog front end for low frequency measurement applications. It contains six differential inputs and includes a low noise instrumentation amplifier, an embedded reference, as well as programmable current sources and a low-side power switch. The update rate can be varied from 4.17 Hz to 500 Hz. It also has an on-board clock, eliminating the need for an external clock. It employs a  $\Sigma$ - $\Delta$  conversion technique to realize up to 16 bits of no missing codes performance. The input signal is applied to an analog modulator. The modulator output is

processed by an on-chip digital filter. The analog input channel of the AD7795 accepts analog input signals of  $\pm V_{REF}/\text{gain}$ , with gain equal to 1 to 128. With a gain of 64 and the update rate programmed to 16.7 Hz, the rms noise is 86 nV. Simultaneous 50 Hz/60 Hz rejection is also available at this data update rate.

Full details on the AD7795 are available in the [AD7795](#) data sheet, available from Analog Devices, Inc., and should be consulted in conjunction with this data sheet when using the evaluation board.

The evaluation board interfaces to the USB port of an IBM-compatible PC. Software is available with the evaluation board, which allows the user to communicate easily with the AD7795. Note that the AD7795 evaluation board software must be installed before connecting the AD7795 evaluation board to the PC.

Other components on the AD7795 evaluation board include the [ADP3303](#) high precision, low power, 3.3 V output, voltage regulator, which is used to power the USB/SPI interface.

### FUNCTIONAL BLOCK DIAGRAM

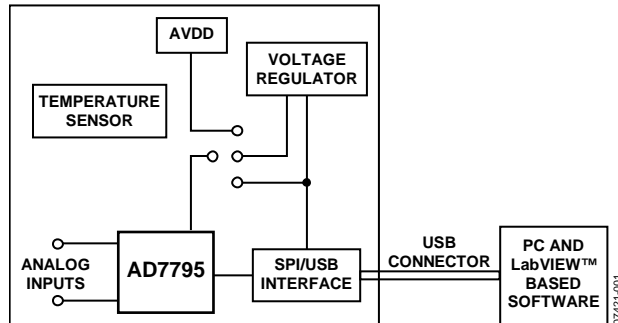

Figure 1.

### Rev. 0

Evaluation boards are only intended for device evaluation and not for production purposes. Evaluation boards are supplied "as is" and without warranties of any kind, express, implied, or statutory including, but not limited to, any implied warranty of merchantability or fitness for a particular purpose. No license is granted by implication or otherwise under any patents or other intellectual property by application or use of evaluation boards. Information furnished by Analog Devices is believed to be accurate and reliable. However, no responsibility is assumed by Analog Devices for its use, nor for any infringements of patents or other rights of third parties that may result from its use. Analog Devices reserves the right to change devices or specifications at any time without notice. Trademarks and registered trademarks are the property of their respective owners. Evaluation boards are not authorized to be used in life support devices or systems.

## TABLE OF CONTENTS

|  |   |   |    |
|--|---|---|----|
| Features .....                           | 1 | Installing the Software .....               | 5  |
| General Description .....                | 1 | Using the Software .....                    | 5  |
| Functional Block Diagram .....           | 1 | Main Window Options.....                    | 6  |
| Revision History .....                   | 2 | Registers.....                              | 7  |
| Evaluation Board Hardware.....           | 3 | Other Registers .....                       | 8  |
| Power Supplies .....                     | 3 | Temp Demo.....                              | 9  |
| Links .....                              | 3 | Evaluation Board Schematic and Artwork..... | 10 |
| Setup Conditions .....                   | 3 | Ordering Information.....                   | 13 |
| Sockets .....                            | 3 | Bill of Materials.....                      | 13 |
| Interfacing to the Evaluation Board..... | 4 | Ordering Guide .....                        | 13 |
| Evaluation Board Software .....          | 5 | ESD Caution.....                            | 13 |
| Software Description.....                | 5 |   |    |

## REVISION HISTORY

4/08—Revision 0: Initial Version

## EVALUATION BOARD HARDWARE

### POWER SUPPLIES

The AD7795 evaluation board is powered via the 5 V supply from the USB connector, J1. This 5 V supply can be used to power the AD7795 directly. A 3.3 V regulated voltage from the on-board ADP3303, a high precision, low power, 3.3 V output, voltage regulator, can also be used. Alternatively, the AD7795 can be powered using an external 3 V or 5 V power supply via J3.

### LINKS

There are eight link options that must be set for the required operating setup before using the evaluation board. The functions of these link options are outlined in Table 1.

**Table 1. Evaluation Board Link Settings**

| Link                   | Default Position | Description  |
|------------------------|------------------|--|
| LK1                    | In               | This link is used to externally short AIN1(+) to AIN1(–). If $V_{BIAS}$ is enabled and directed to AIN1(–), a noise analysis in this configuration can be performed. With this link removed, an external voltage can be applied to AIN1(+)/AIN1(–) using the SMB connectors.   |
| LK2, LK3 LK4, LK5, LK6 | Out              | These links are used to connect the on-board temperature demonstration circuit to the ADC, and must all be in place when attempting to measure ambient temperature.<br>With the on-board temperature demonstration circuit selected in the software, LK6, when inserted, allows current from the on-chip current source of the AD7795 to flow through the temperature demonstration circuit. LK4 and LK5, when inserted, connect the 1 k $\Omega$ thermistor to AIN4(+)/AIN4(–), and with LK2 and LK3 inserted, the 5 k $\Omega$ precision resistor is used to generate the reference for the AD7795 so that a ratiometric configuration of the temperature demonstration circuit is achieved. |
| LK7                    | Out              | LK7 is used to test the on-chip low-side power switch. If LK7 is in place, enabling the low-side power switch via the <b>PWR SW</b> drop-down box in the <b>Registers</b> window (see Figure 4) turns on the LED, D2. Clearing this bit turns off the LED.   |
| LK8                    | B                | LK8 is used to select the power source for $AV_{DD}$ on the AD7795. LK8 in Position A selects an external power supply, supplied via J3. LK8 in Position B selects the 3.3 V regulated output from the on-board ADP3303 voltage regulator. LK8 in Position C selects the 5 V supply from the USB connector, J1.  |

**Table 2. Initial Link and Switch Positions**

| Link No. | Position | Description   |
|----------|----------|---|
| LK1      | In       | AIN1(+) and AIN1(–) are shorted.  |
| LK2, LK3 | Out      | Internal reference is used.   |
| LK4, LK5 | Out      | AIN4(+) and AIN4(–) are not connected to the temperature demonstration circuit. |
| LK6      | Out      | IOOUT2 is not connected to the temperature demonstration circuit.               |
| LK7      | Out      | LED D1 is not connected to the low-side power switch of the AD7795.             |
| LK8      | B        | The 3.3 V supply is used as $AV_{DD}$ for the AD7795.                           |

**Table 3. Socket Functions**

| Socket  | Description  |
|---------|--|
| AIN1+   | Subminiature BNC (SMB) connector. The analog input signal for the AIN1(+) input of the AD7795 is applied to this socket.   |
| AIN1–   | Subminiature BNC (SMB) connector. The analog input signal for the AIN1(–) input of the AD7795 is applied to this socket.   |
| REFIN1+ | Subminiature BNC (SMB) connector. This socket is used in conjunction with REFIN1– to apply an external reference to the AD7795. The voltage for the REFIN1(+) input of the AD7795 is applied to this socket. |
| REFIN1– | Subminiature BNC (SMB) connector. This socket is used in conjunction with REFIN1+ to apply an external reference to the AD7795. The voltage for the REFIN1(–) input of the AD7795 is applied to this socket. |
| J2      | 30-pin (2 $\times$ 15) straight header. This socket is used in conjunction with the prototype area to interface any signal to the AD7795.  |

### SETUP CONDITIONS

Care should be taken before applying power and signals to the evaluation board to ensure that all link positions are set per the required operating mode. Table 2 shows the position in which all the links are initially set.

### SOCKETS

There are five sockets relevant to the operation of the AD7795 on this evaluation board. The functions of these sockets are outlined in Table 3.

# EVAL-AD7795

## INTERFACING TO THE EVALUATION BOARD

Interfacing to the evaluation board is via a standard USB connector, J1. J1 is used to connect the evaluation board to the USB port of a PC. A standard USB connector cable is included with the AD7795 evaluation board to allow the evaluation board to interface with the USB port of the PC. Because the board is powered via the USB connector, there is no need for an external power supply, although one can be connected if preferred, via J3.

Communication between the AD7795 and the PC is via the USB/SPI interface. The on-board USB controller (U2) controls this communication.

1. Install the AD7795 evaluation board software, using the supplied AD7795 evaluation board CD-ROM, before connecting the board to the PC.
2. When installation of the AD7795 evaluation board software is complete, use the supplied USB connector cable to connect the board to the PC via J1 on the AD7795 evaluation board and the USB port on the PC. The PC automatically detects the new USB device and identifies it as the **AD779x Evaluation Board**.
3. Follow the onscreen instructions that appear automatically. During the installation process, if the **Hardware Installation** window appears (see Figure 2), click **Continue Anyway** to successfully complete the installation of the AD7795 evaluation board.



Figure 2. Hardware Installation

## EVALUATION BOARD SOFTWARE

### SOFTWARE DESCRIPTION

The AD7795 evaluation board is shipped with a CD-ROM containing software that can be installed onto a standard PC to control the AD7795. The software uses the USB of the PC to communicate with the AD7795, via the cable that accompanies the board.

The software allows you to configure the AD7795 and to read conversion data from the AD7795.

Data can be read from the AD7795 and displayed or stored for later analysis. For further information, see the AD7795 data sheet available at [www.analog.com](http://www.analog.com).

### INSTALLING THE SOFTWARE

To install the software

1. Start Windows® and insert the CD-ROM.
2. The installation software should launch automatically. If it does not, use Windows Explorer to locate the file **setup.exe** on the CD-ROM. Double-click this file to start the installation procedure.
3. At the prompt, select a destination directory, which is **C:\Program Files\Analog Devices\AD7795** by default.

Once the directory is selected, the installation procedure copies the files into the relevant directories on the hard drive. The installation program creates a program group called **Analog Devices** with the subgroup **AD7795** in the **Start** menu of the taskbar.

4. Once the installation procedure is complete, double-click the AD7795 icon to start the program.

### USING THE SOFTWARE

Figure 3 shows the main window that is displayed when the program starts. The Main Window Options section briefly describes the various menu and button options on the main window. The Registers, Other Registers, and Temp Demo sections describe the most commonly used evaluation software windows.

The data that has been read can be exported to other packages, such as MathCAD™ or Microsoft® Excel, for further analysis.

On power-up, the AD7795 evaluation board software configures the device to have a gain of 64, the internal reference is selected, the AIN1(-)/AIN1(-) channel is selected, the bias voltage is enabled on AIN1(-), the update rate is set to 16.7 Hz, and chop is enabled.

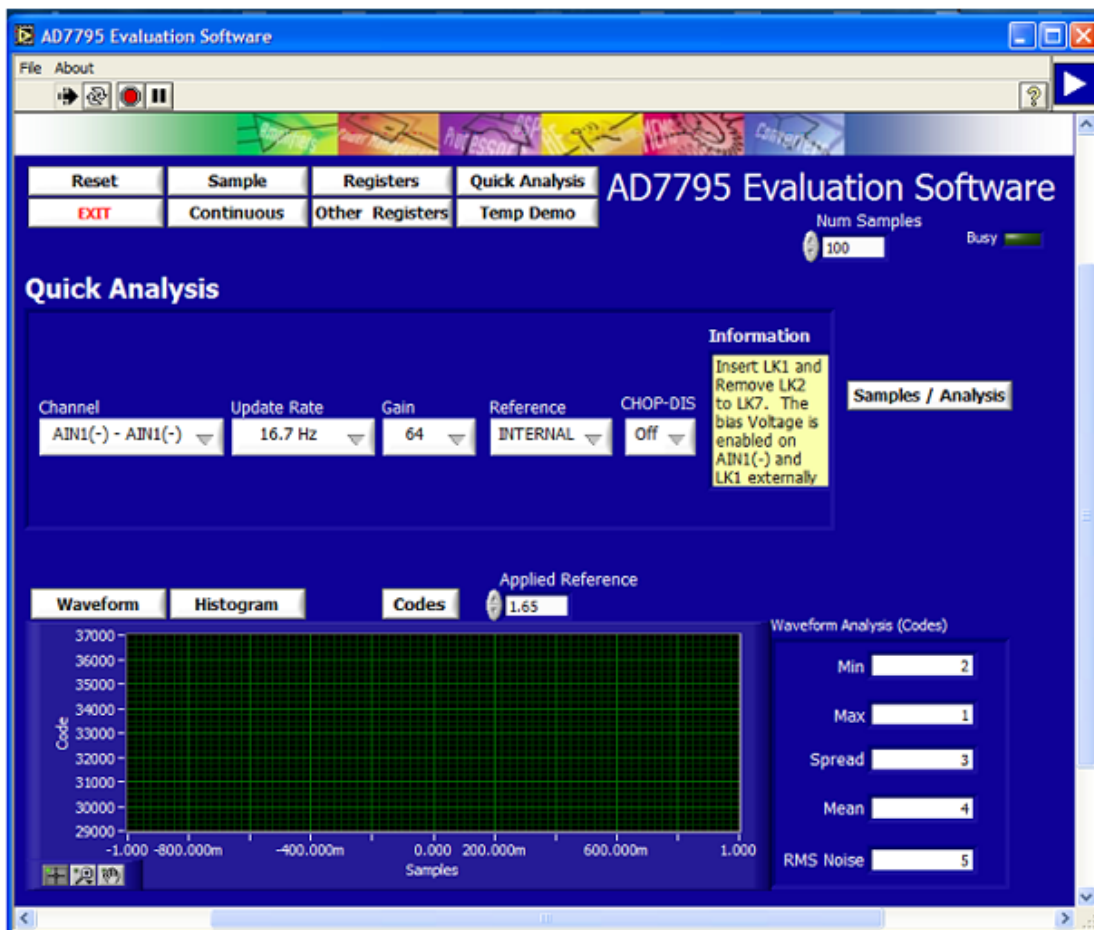

Figure 3. AD7795 Evaluation Software Main Window

## MAIN WINDOW OPTIONS

### Menu Bar

**File.** Allows you to read previously stored data for display or analysis, write the current set of data to a file for later use, and exit the program.

**About.** Provides information on the revision of software being used.

### Buttons

**Reset.** Allows you to reset the AD7795 and set the registers to the power-up conditions as specified by the software (channel = AIN1(-)/AIN1(-), bias voltage generator enabled on AIN1(-), gain = 64, update rate = 16.7 Hz, internal reference, chop enabled).

**Exit.** Allows you to exit the software. It serves the same purpose as the **Quit** option in the **File** drop-down menu.

**Sample.** Allows you to read a number of samples from the AD7795. Noise analysis is then performed on the samples. These samples can be stored for further analysis.

The sample size is entered in the **Num Samples** spin box.

**Continuous.** Allows you to read a number of samples continuously. The software gathers a number of samples as specified by **Num Samples**, performs noise analysis on the samples, and then gathers the next group of samples.

**Registers.** Allows you to access the configuration register, mode register, and IO register.

**Other Registers.** Allows you to access the ID register, status register, offset register, and full-scale register.

**Quick Analysis.** Displays the **Quick Analysis** window. The **Quick Analysis** window gives you access to a subset of the AD7795 control bits: channel, update rate, gain, reference source, and chop. For access to all control bits, click the **Registers** button or the **Other Registers** button.

**Temp Demo.** Allows you to access the temperature demonstration software.

**Samples/Analysis.** Serves the same purpose as the **Sample** button.

**Waveform.** The gathered conversions are displayed in graph form.

**Histogram.** The gathered samples are used to generate a histogram.

**Codes.** The gathered samples can be displayed in code or in voltage format. When the **Codes** button is clicked, the values are displayed as code and the **Codes** button changes to **Volts**. To display the information in volts, click the **Volts** button.

**Applied Reference.** By default, the internal reference is used. To use an external reference, **Reference** in the **Quick Analysis** window should be set to REFIN1 if the external reference is applied between REFIN1(+) and REFIN1(-), or set to REFIN2 if the applied reference is applied between REFIN2(+) and REFIN2(-). The value of the external reference should be entered in the **Applied Reference** spin box.

**REGISTERS**

To access the configuration register, the mode register, and the IO register, click the **Registers** button (see Figure 4). This

window allows you to change the update rate, the reference source, and the clock source, among other options. Consult the AD7795 data sheet for further details on the bit functions.

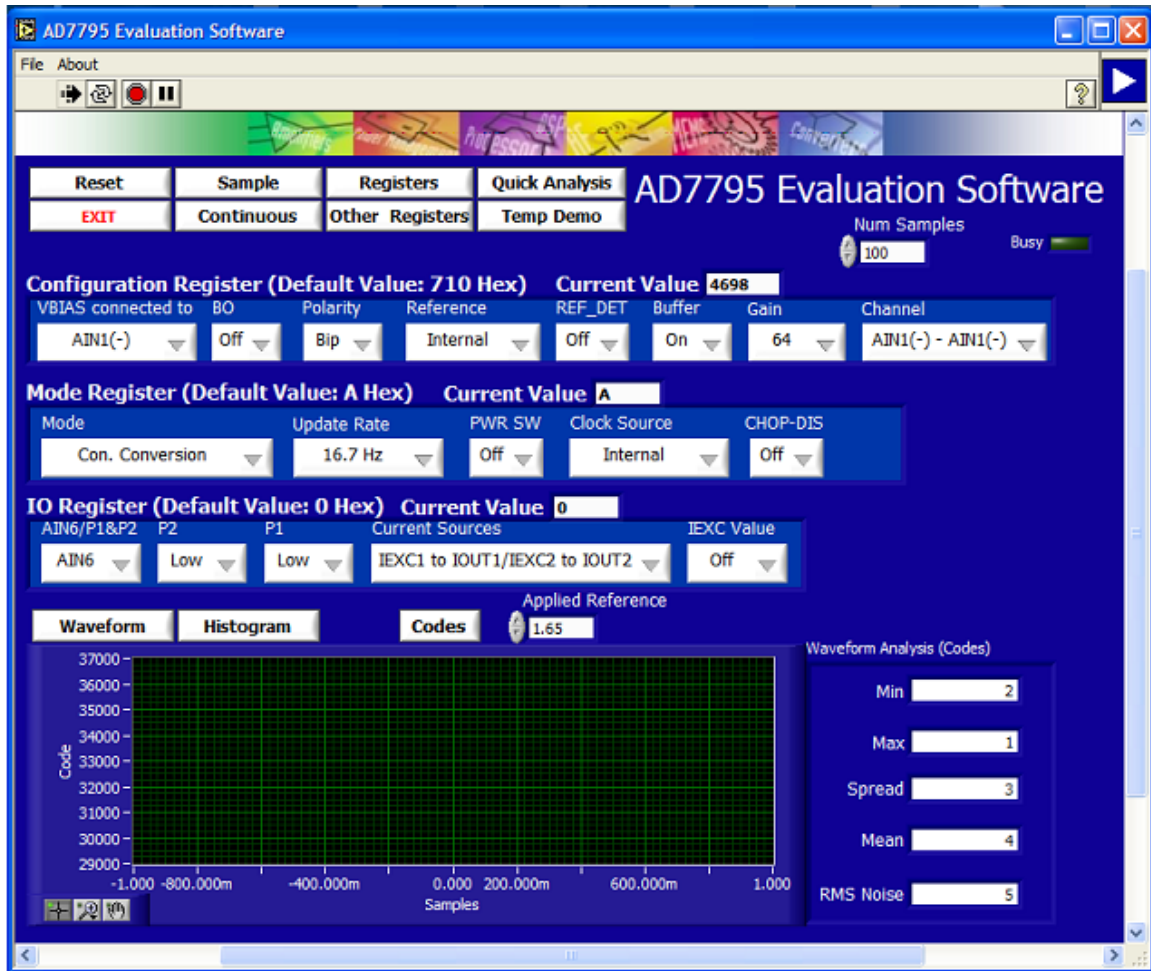

Figure 4. AD7795 Evaluation Software Registers Window

# EVAL-AD7795

## OTHER REGISTERS

To access additional registers, click the **Other Registers** button (see Figure 5). This window displays the contents of the offset calibration register, the ID register, the full-scale calibration

register, and the status register. To write to the offset calibration and full-scale calibration registers, you must place the AD7795 in power-down or idle mode using the **Mode** box in the **Registers** window (see Figure 4).

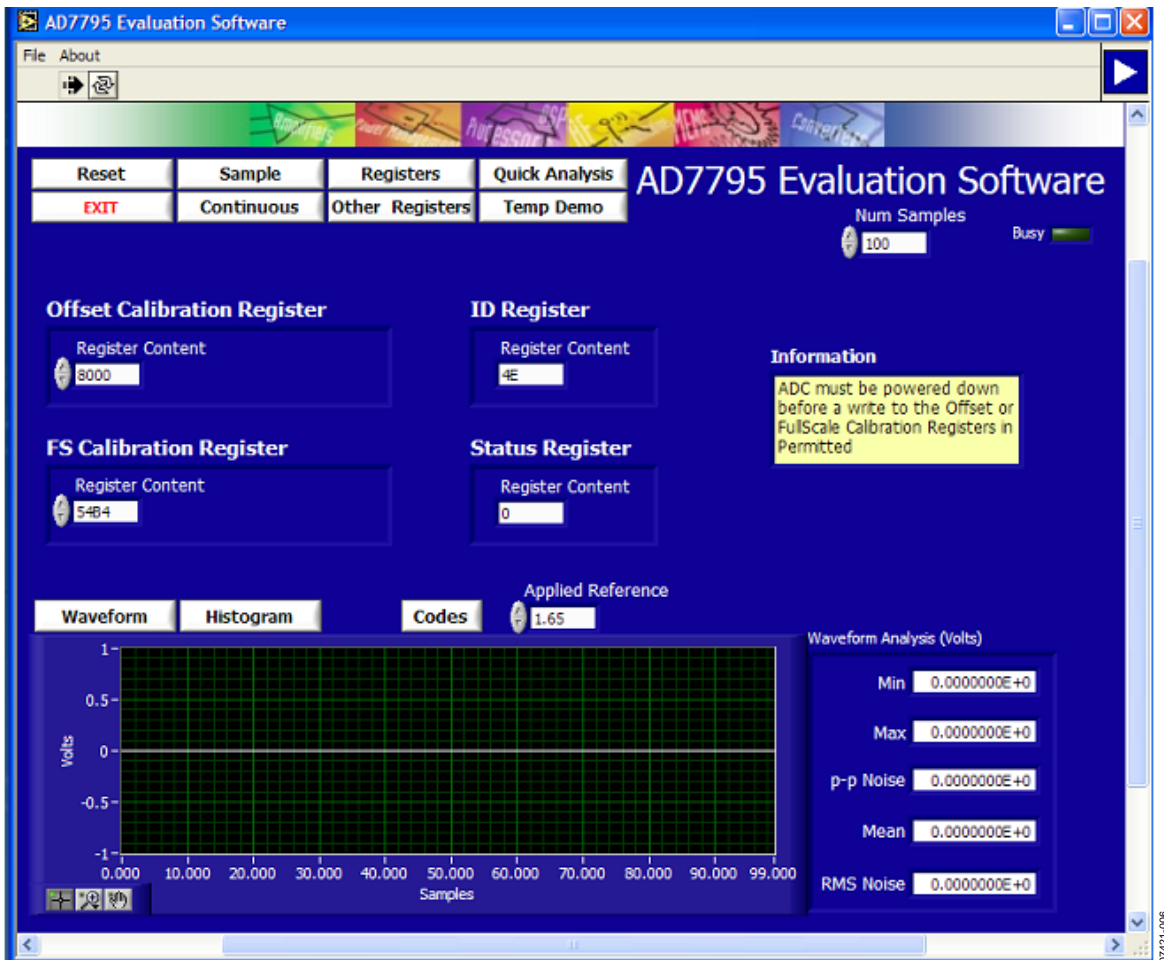

Figure 5. AD7795 Evaluation Software Other Registers Window



## TEMP DEMO

To access the temperature demonstration window, click the **Temp Demo** button. The AD7795 evaluation board has a temperature demonstration included on the board. To operate the temperature demonstration, LK2 to LK6 should be inserted and LK1 should be removed. With these links in place, the AD7795 excitation current is connected to a 1 k $\Omega$  thermistor, which is connected across the AIN4(+)/AIN4(-) pins. In series with the thermistor is a 5 k $\Omega$  precision resistor that is used to generate the reference voltage. The ratiometric configuration optimizes the system performance. The temperature demonstration software saves the values in the mode register, the configuration register, and the IO register.

The software then configures the AD7795 to operate with a 210  $\mu$ A excitation current, the AIN4(+)/AIN4(-) channel is selected as the analog input, the gain is set to 1, and the external reference REFIN1(+)/REFIN1(-) is selected. When the **Run** button is clicked, the software continuously reads the conversion from the AIN4(+)/AIN4(-) channel and converts the result to temperature using a lookup table.

When **Run** is clicked again, the temperature demonstration execution is halted. To exit the temperature demonstration, click the **Back** button. The software sets the configuration register, the mode register, and the I/O register to their pre-temperature demonstration values.



Figure 6. AD7795 Temperature Demo Window

## EVALUATION BOARD SCHEMATIC AND ARTWORK

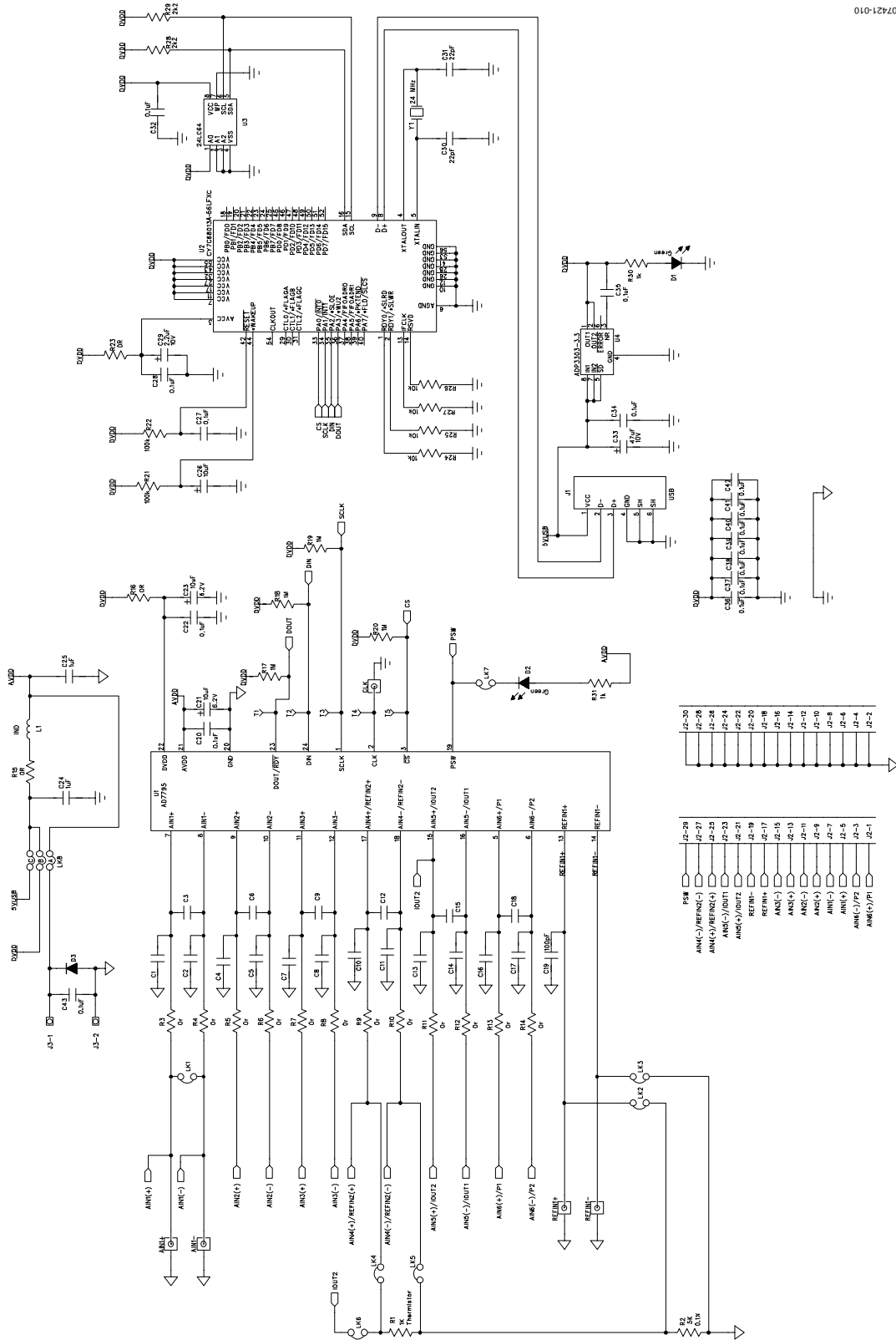

07421-010

Figure 7. AD7795 Evaluation Board Schematic

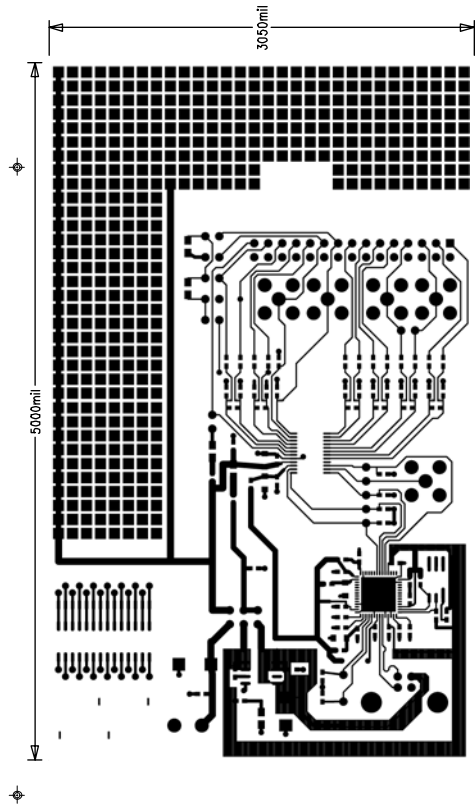

Figure 8. AD7795 Evaluation Board Component Side Artwork

07420-009

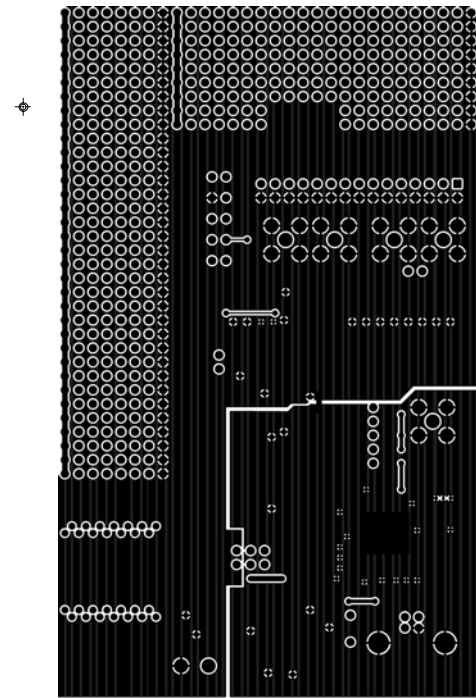

Figure 9. AD7795 Evaluation Board Solder Side Artwork

07420-008

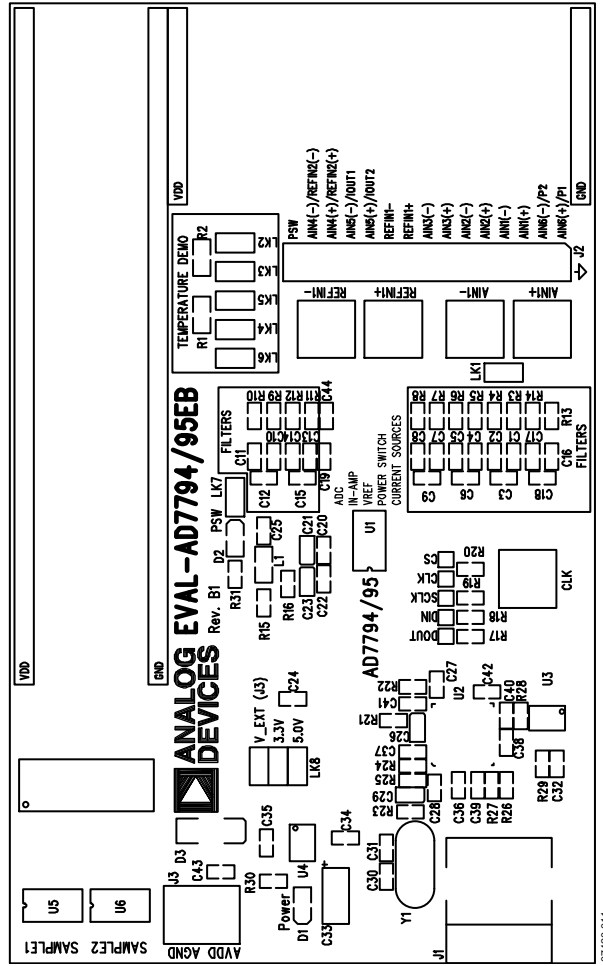

Figure 10. AD7795 Evaluation Board Component Layout Diagram

## ORDERING INFORMATION

### BILL OF MATERIALS

Table 4.

| Qty | Reference Designator                                  | Description                   | Manufacturer/Part No.                                |
|-----|---|-------------------------------|--|
|     | Integrated Circuits                                   |                               |  |
| 3   | U1, U5, U6  | AD7795BRUZ                    | Analog Devices                                       |
| 1   | U2  | USB controller                | Cypress Semiconductor Corporation, CY7C68013A-56LFXC |
| 1   | U3  | 24LC64                        | Microchip Technology Inc., 24LC64-I/SN               |
| 1   | U4  | ADP3303ARZ-3.3                | Analog Devices                                       |
| 1   | Y1  | 24 MHz crystal                | AEL Crystals, X24M000000S244                         |
| 2   | D1, D2  | Green LED                     | Fairchild Semiconductor, QTLP630C-4                  |
| 1   | L1  | Ferrite bead                  | Meggitt Sigma, BMB2A0300AN1                          |
| 1   | D3  | Diode                         | Micro Commercial Components Corp., DL4001-TP         |
|     | Capacitors  |                               |  |
| 19  | C1 to C18, C44  | Capacitors                    | Not inserted   |
| 1   | C19   | 100 pF ceramic                | AVX Corporation, 06035A101JAT2A                      |
| 15  | C20, C22, C27, C28, C32, C34 to C43                   | 0.1 $\mu$ F $\pm$ 10% ceramic | AVX Corporation, CM105X7R104K16AT                    |
| 3   | C21, C23, C26   | 10 $\mu$ F tantalum           | AVX Corporation, TAJA106K010R                        |
| 2   | C24, C25  | 1 $\mu$ F ceramic             | Yageo Corporation, 2238 246 19863                    |
| 1   | C29   | 2.2 $\mu$ F tantalum          | EPCOS AG, B45196E2225K109                            |
| 2   | C30, C31  | 22 pF ceramic                 | Yageo Corporation, 2238 867 15229                    |
| 1   | C33   | 47 $\mu$ F tantalum           | AVX Corporation, TAJC476K016R                        |
|     | Resistors   |                               |  |
| 1   | R1  | 1 k $\Omega$ thermistor       | EPCOS AG, B57620C102J62                              |
| 1   | R2  | 5 k $\Omega$ $\pm$ 0.1%       | Tyco International, Ltd., RN73C2A4K99BTG             |
| 15  | R3 to R16, R23  | 0 $\Omega$ resistor           | Multicomp, MC 0.063W 0603 0R                         |
| 4   | R17 to R20  | 1 M $\Omega$ resistor         | Multicomp, MC 0.063W 0603 1% 1M                      |
| 2   | R21, R22  | 100 k $\Omega$ resistor       | Multicomp, MC 0.063W 0603 1% 100K                    |
| 4   | R24 to R27  | 10 k $\Omega$ resistor        | Multicomp, MC 0.063W 0603 1% 10K                     |
| 2   | R28, R29  | 2.2 k $\Omega$ resistor       | Multicomp, MC 0.063W 0603 1% 2K2                     |
| 2   | R30, R31  | 1 k $\Omega$ resistor         | Multicomp, MC 0.063W 0603 1% 1K                      |
|     | Links   |                               |  |
| 8   | LK1 to LK7 (2 $\times$ 1 way), LK8 (3 $\times$ 2 way) | Pin headers                   | Harwin Plc, M20-9983646                              |
| 8   | At LK1 to LK8   | Shorting plugs                | Harwin Plc, M7566-05                                 |
|     | Connectors  |                               |  |
| 4   | AIN1+, AIN1-, REFIN1+, REFIN1-, CLK                   | SMB connector                 | Not inserted   |
| 1   | J1  | USB Mini-B connector          | Molex, 565790576                                     |
| 1   | J2  | 30-pin (2 $\times$ 15) header | Harwin Plc, M20-9983646                              |
| 1   | J3  | 2-way terminal block          | Camden Electronics Ltd., CTB5000/2                   |

### ORDERING GUIDE

| Model         | Description      |
|---------------|------------------|
| EVAL-AD7795EB | Evaluation Board |

### ESD CAUTION



**ESD (electrostatic discharge) sensitive device.** Charged devices and circuit boards can discharge without detection. Although this product features patented or proprietary protection circuitry, damage may occur on devices subjected to high energy ESD. Therefore, proper ESD precautions should be taken to avoid performance degradation or loss of functionality.

**EVAL-AD7795**

**NOTES**

**NOTES**

**EVAL-AD7795**

**NOTES**