



Parameter	Rating	Units
LED Operating Range	2-10	mA
K3, Transfer Gain	0.887-1.072	-
Isolation, Input to Output	3750	V <sub>rms</sub>

### Features

- 0.01% Servo Linearity
- THD -87dB Typical
- Wide Bandwidth (>200kHz)
- Couples Analog and Digital Signals
- High Gain Stability
- Low Input-to-Output Capacitance
- Low Power Consumption
- 8-Pin Flatpack or DIP Package
- Surface Mount and Tape & Reel Versions Available
- VDE Compatible

### Applications

- Modem Transformer Replacement With No Insertion Loss
- Digital Telephone Isolation
- Power Supply Feedback Voltage/Current
- Medical Sensor Isolation
- Audio Signal Interfacing
- Isolation of Process Control Transducers

### Description

The LOC117 Single Linear Optocoupler features an infrared LED optically coupled with two photodiodes. One feedback (input) photodiode is used to generate a control signal that provides a servomechanism to the LED drive current, thus compensating for the LED's nonlinear time and temperature characteristics. The other (output) photodiode provides an output signal that is linear with respect to the servo LED current. The product features wide bandwidth, high input to output isolation, and excellent servo linearity.

### Approvals

- UL Recognized Component: File # E76270
- CSA Certified Component: Certificate # 1175739
- EN/IEC 60950-1 Certified Component:  
TUV Certificate # B 13 12 82667 003

### Ordering Information

Part #	Description
LOC117	8-Pin DIP (50/tube)
LOC117P	8-Pin Flatpack (50/tube)
LOC117PTR	8-Pin Flatpack (1000/Reel)
LOC117S	8-Pin Surface Mount (50/tube)
LOC117STR	8-Pin Surface Mount (1000/Reel)

### Pin Configuration

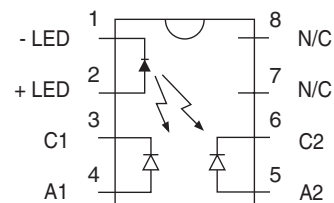

### Absolute Maximum Ratings @ 25°C

Parameter	Ratings	Units
Reverse Input Voltage	5	V
Input Control Current	100	mA
Peak (10ms)	1	A
Input Power Dissipation <sup>1</sup>	150	mW
Total Package Dissipation <sup>2</sup>	500	mW
Isolation Voltage, Input to Output	3750	V <sub>rms</sub>
Operational Temperature	-40 to +85	°C
Storage Temperature	-40 to +125	°C

<sup>1</sup> Derate linearly 1.33 mW / °C

<sup>2</sup> Derate linearly 6.67 mW / °C

Absolute Maximum Ratings are stress ratings. Stresses in excess of these ratings can cause permanent damage to the device. Functional operation of the device at conditions beyond those indicated in the operational sections of this data sheet is not implied.

Typical values are characteristic of the device at +25°C, and are the result of engineering evaluations. They are provided for information purposes only, and are not part of the manufacturing testing requirements.

### Electrical Characteristics @ 25°C

Parameter	Conditions	Symbol	Min	Typ	Max	Units
<b>Input Characteristics</b>						
LED Voltage Drop	I <sub>F</sub> =2 - 10mA	V <sub>F</sub>	0.9	1.2	1.4	V
Reverse LED Current	V <sub>R</sub> =5V	I <sub>R</sub>	-	-	10	µA
<b>Coupler/Detector Characteristics</b>						
Dark Current	I <sub>F</sub> =0mA, V <sub>C1-A1</sub> =V <sub>C2-A2</sub> =15V	I <sub>D</sub>	-	1	25	nA
K1, Servo Gain (I <sub>C1</sub> /I <sub>F</sub> )	I <sub>F</sub> =2 - 10mA, V <sub>C1-A1</sub> =V <sub>C2-A2</sub> =15V	K1	0.008	-	0.030	-
K2, Forward Gain (I <sub>C2</sub> /I <sub>F</sub> )		K2	0.006	-	0.030	-
K3, Transfer Gain (K <sub>2</sub> /K <sub>1</sub> = I <sub>C2</sub> /I <sub>C1</sub> )		K3	0.887	-	1.072	-
ΔK3, Transfer Gain Linearity (non-servoed)	I <sub>F</sub> =2 - 10mA	ΔK3	-	-	1	%
K3 Temperature Coefficient	I <sub>F</sub> =2 - 10mA, V <sub>C1-A1</sub> =V <sub>C2-A2</sub> =5V	ΔK3/ΔT	-	0.005	-	% / °C
Common Mode Rejection Ratio	V=20V <sub>P-P</sub> , R <sub>L</sub> =2KΩ, f=100Hz	CMRR	-	130	-	dB
Total Harmonic Distortion	f <sub>0</sub> =350Hz, 0dBm	THD	-96	-87	-80	dB
Frequency Response <sup>1</sup>	Photoconductive Configuration	f <sub>-3dB</sub>	-	200	-	kHz
	Photovoltaic Configuration		-	40	-	kHz
<b>Common Characteristics</b>						
Input/Output Capacitance	V <sub>IO</sub> =0V, f=1MHz	C <sub>IO</sub>	-	3	-	pF

<sup>1</sup> Refer to Application Note, AN-107, for LOC117 configurations.

**PERFORMANCE DATA @25°C (Unless Otherwise Noted)\***

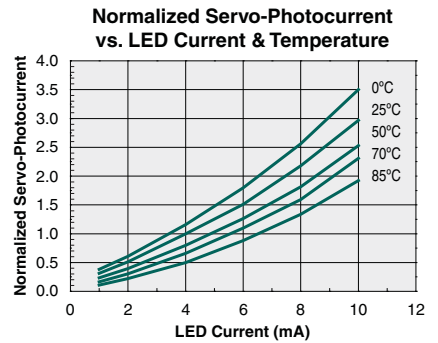
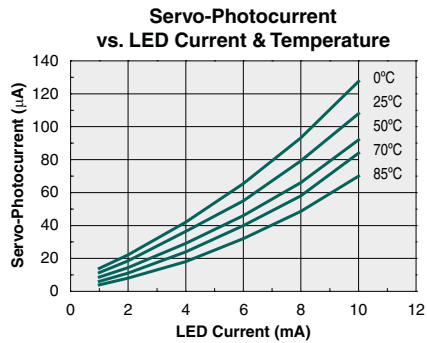
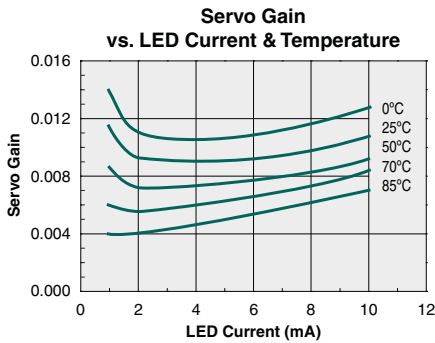
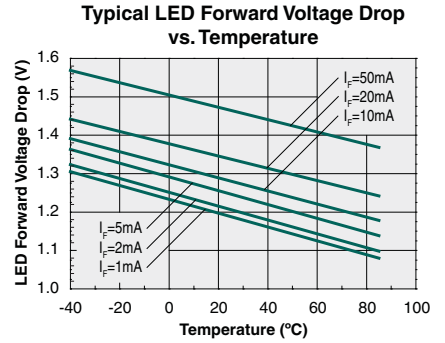
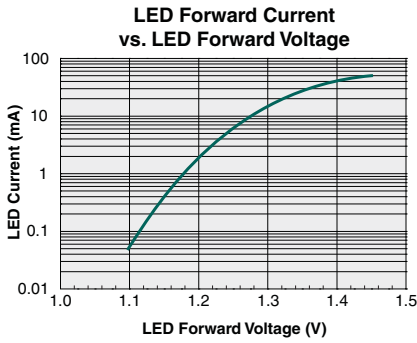
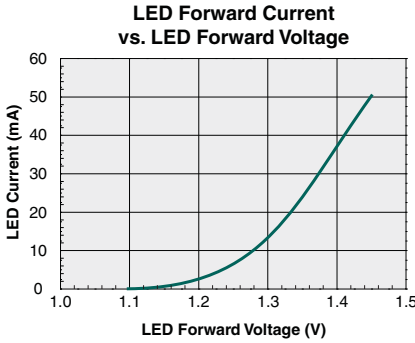

\*The Performance data shown in the graphs above is typical of device performance. For guaranteed parameters not indicated in the written specifications, please contact our application department.

## Manufacturing Information

### Moisture Sensitivity



All plastic encapsulated semiconductor packages are susceptible to moisture ingress. IXYS Integrated Circuits Division classified all of its plastic encapsulated devices for moisture sensitivity according to the latest version of the joint industry standard, **IPC/JEDEC J-STD-020**, in force at the time of product evaluation. We test all of our products to the maximum conditions set forth in the standard, and guarantee proper operation of our devices when handled according to the limitations and information in that standard as well as to any limitations set forth in the information or standards referenced below.

Failure to adhere to the warnings or limitations as established by the listed specifications could result in reduced product performance, reduction of operable life, and/or reduction of overall reliability. This product carries a Moisture Sensitivity Level (MSL) classification as shown below, and should be handled according to the requirements of the latest version of the joint industry standard **IPC/JEDEC J-STD-033**.

Device	Moisture Sensitivity Level (MSL) Classification
LOC117 / LOC117S	MSL 1
LOC117P	MSL 3

### ESD Sensitivity



This product is **ESD Sensitive**, and should be handled according to the industry standard **JESD-625**.

### Soldering Profile

Provided in the table below is the Classification Temperature ( $T_C$ ) of this product and the maximum dwell time the body temperature of this device may be above ( $T_C - 5$ )°C. The classification temperature sets the Maximum Body Temperature allowed for this device during lead-free reflow processes. For through hole devices, and any other processes, the guidelines of **J-STD-020** must be observed.

Device	Classification Temperature ( $T_C$ )	Dwell Time ( $t_p$ )	Max Reflow Cycles
LOC117	250°C	30 seconds	N/A
LOC117S	250°C		3
LOC117P	240°C		3

### Board Wash

IXYS Integrated Circuits Division recommends the use of no-clean flux formulations. Board washing to reduce or remove flux residue following the solder reflow process is acceptable provided proper precautions are taken to prevent damage to the device. These precautions include, but are not limited to: using a low pressure wash and providing a follow up bake cycle sufficient to remove any moisture trapped within the device due to the washing process. Due to the variability of the wash parameters used to clean the board, determination of the bake temperature and duration necessary to remove the moisture trapped within the package is the responsibility of the user (assembler). Cleaning or drying methods that employ ultrasonic energy may damage the device and should not be used. Additionally, the device must not be exposed to flux or solvents that are Chlorine- or Fluorine-based.



**Mechanical Dimensions**

**LOC117**

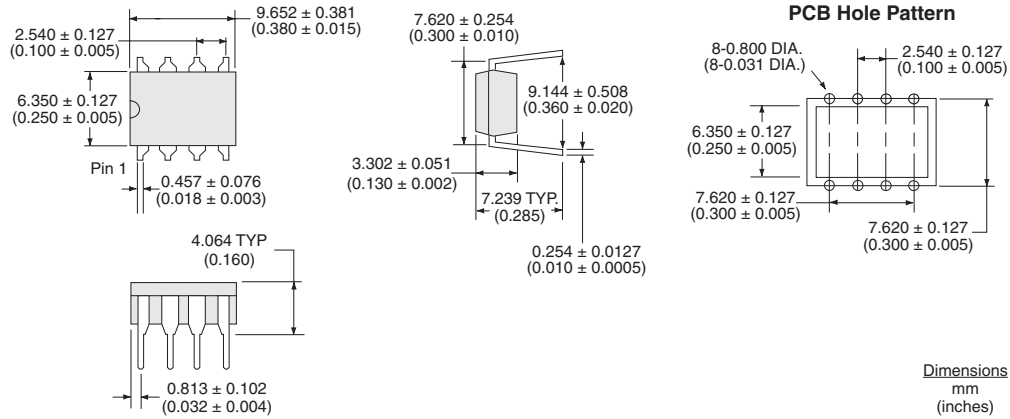

**LOC117P**

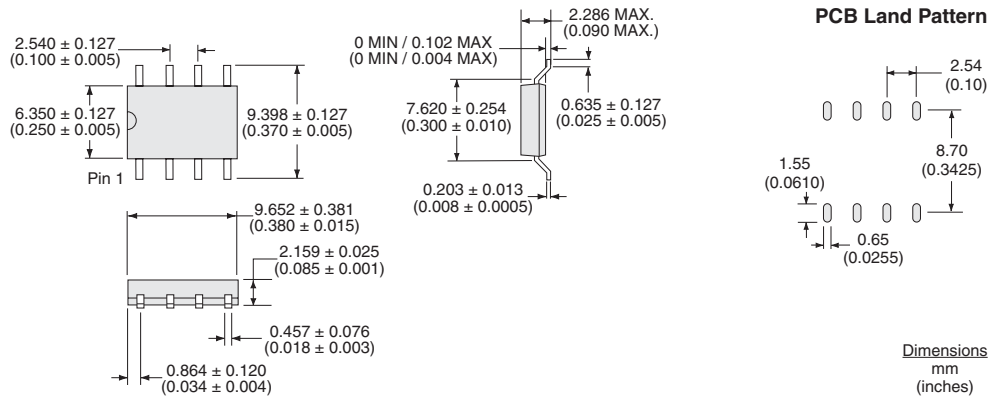

**LOC117S**

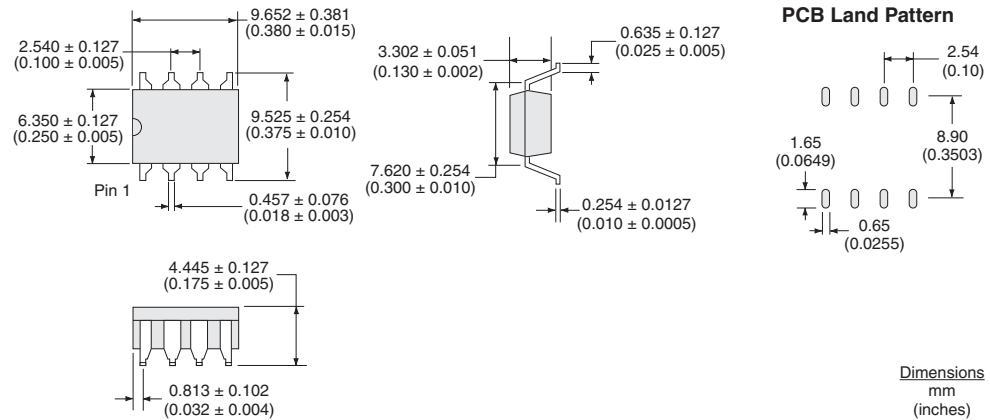

### LOC117PTR Tape & Reel

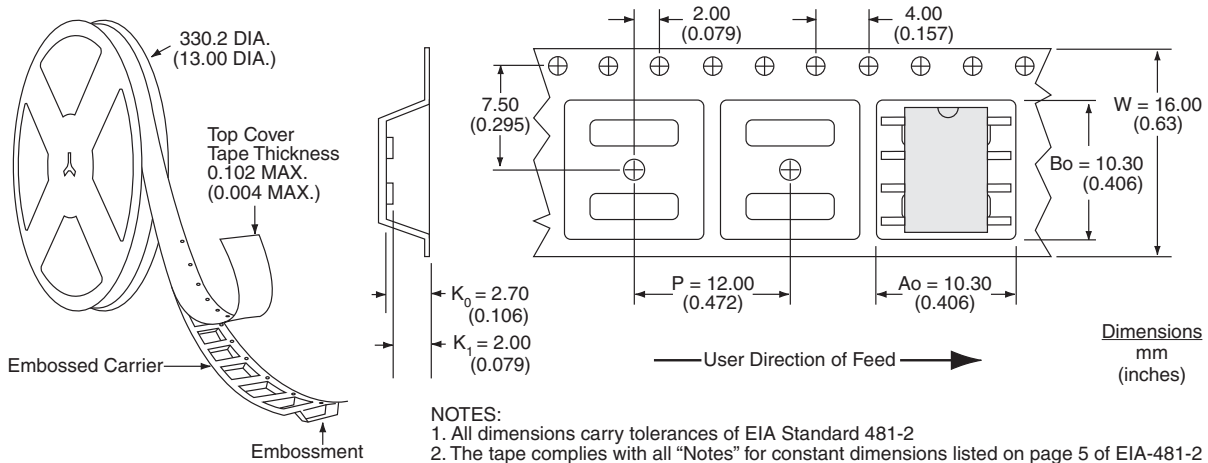

### LOC117STR Tape & Reel

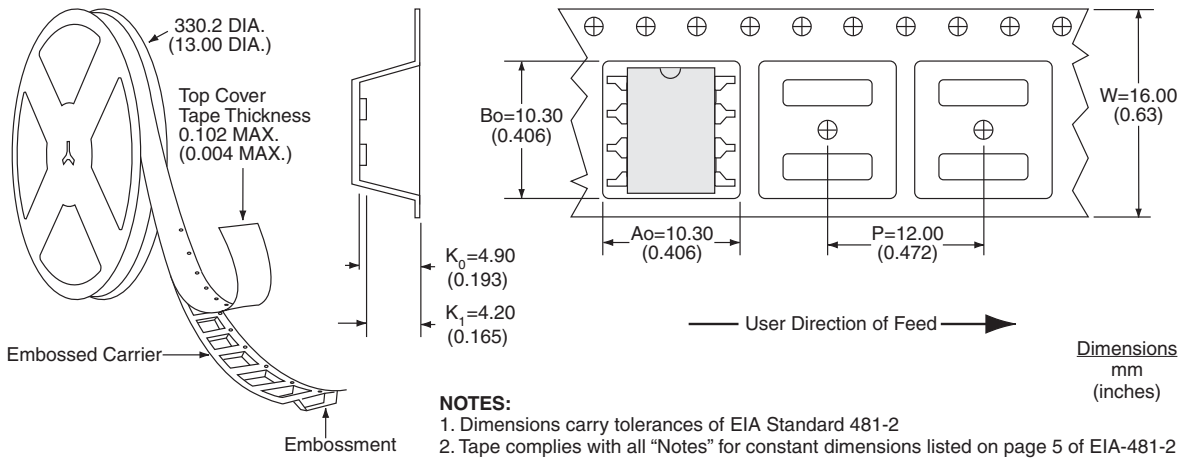

For additional information please visit our website at: [www.ixysic.com](http://www.ixysic.com)

IXYS Integrated Circuits Division makes no representations or warranties with respect to the accuracy or completeness of the contents of this publication and reserves the right to make changes to specifications and product descriptions at any time without notice. Neither circuit patent licenses nor indemnity are expressed or implied. Except as set forth in IXYS Integrated Circuits Division's Standard Terms and Conditions of Sale, IXYS Integrated Circuits Division assumes no liability whatsoever, and disclaims any express or implied warranty, relating to its products including, but not limited to, the implied warranty of merchantability, fitness for a particular purpose, or infringement of any intellectual property right.

The products described in this document are not designed, intended, authorized or warranted for use as components in systems intended for surgical implant into the body, or in other applications intended to support or sustain life, or where malfunction of IXYS Integrated Circuits Division's product may result in direct physical harm, injury, or death to a person or severe property or environmental damage. IXYS Integrated Circuits Division reserves the right to discontinue or make changes to its products at any time without notice.