

## 1. General Description

The AP1154ADLXX is a low dropout linear regulator with ON/OFF control, which can supply 1A load current. The IC is an integrated circuit with a silicon monolithic bipolar structure. The output voltage, trimmed with high accuracy, is available from 1.8 to 5.0V in 0.1V steps. The output capacitor is available to use a small 1 $\mu$ F ceramic capacitor. The IC can be used for USB application (500mA), since the output limitation current can be set by external resistor. The over current, thermal and reverse bias protections are integrated, and also the package is high heat radiation type, HSOP-8. The IC is designed for space saving requirements.

## 2. Feature

- Available to use a small 1 $\mu$ F ceramic capacitor
- Dropout voltage  $V_{DROD}=160\text{mV}$  at 500mA
- Output current 1A
- High precision output voltage  $\pm 1.5\%$  or  $\pm 50\text{mV}$
- High ripple rejection ratio 80dB at 1kHz
- Wide operating voltage range 2.4V to 14.0V
- Very low quiescent current  $I_Q=320\mu\text{A}$  at  $I_{OUT}=0\text{mA}$
- Programmable output current limitation by an external resistor
- On/Off control (High active)
- Built-in Short circuit protection, thermal shutdown
- Built-in reverse bias over current protection
- Available very low noise application
- Small package HSOP-8

## 3. Application

- Power supply for low voltage MPU and peripheral equipment
- Digital AV system
- Any electronic equipment

<b>4. Table of Contents</b>
-----------------------------

1. General Description .....	1
2. Feature.....	1
3. Application.....	1
4. Table of Contents .....	2
5. Block Diagram .....	3
6. Ordering Information .....	3
7. Pin Configurations and Functions.....	4
■ Pin Configurations .....	4
■ Functions.....	4
8. Absolute Maximum Rating .....	5
9. Recommended Operating Conditions .....	5
10. Electrical Characteristics.....	6
■ Electrical Characteristics of Ta=Tj=25°C .....	6
■ Electrical Characteristics of Ta=-40°C~85°C.....	7
11. Description .....	8
11.1 DC Characteristics .....	8
11.2 ON/OFF Transient .....	16
11.3 Line transient .....	17
11.4 Load transient .....	18
11.5 Ripple Rejection .....	20
11.6 Output Noise .....	21
11.7 Setting of output current limitation.....	22
11.8 Stability.....	24
11.9 Operating Region and Power Dissipation.....	25
11.10 Operating Region and Power Dissipation .....	26
12. Definition of term.....	27
13. Recommended External Circuits .....	28
14. Package.....	29
■ Outline Dimensions.....	29
15. Revise History .....	30
IMPORTANT NOTICE .....	31

**5. Block Diagram**

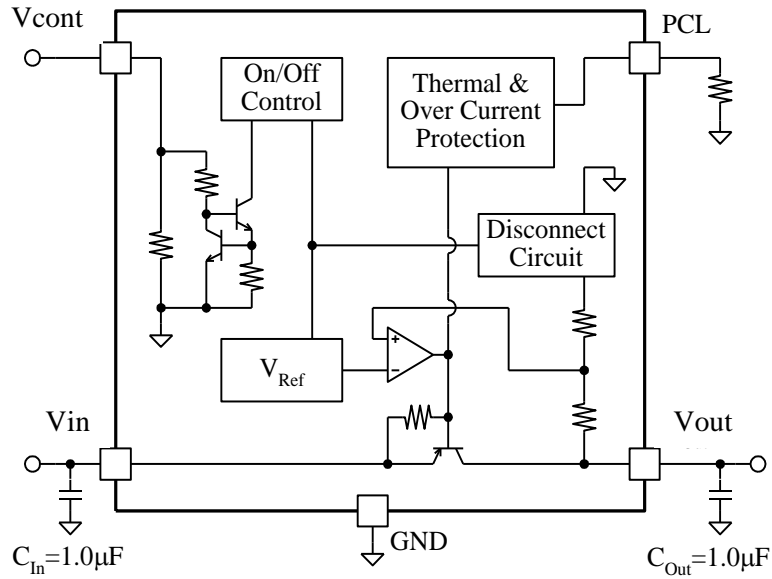

Figure 1. Block Diagram

**6. Ordering Information**

AP1154ADLXX      Ta = -40 to 85°C      HSOP-8

- Output Voltage Code

For product name, please check the below chart. Please contact your authorized ASAHI KASEI MICRODEVICES representative for voltage availability.

AP1154ADLXX  
└─── Output voltage code

Table 1. Standard Voltage Version, Output Voltage & Voltage Code

XX	V <sub>OUT</sub>	XX	V <sub>OUT</sub>	XX	V <sub>OUT</sub>
18	1.8	25	2.5	33	3.3
21	2.1	30	3.0	50	5.0

**7. Pin Configurations and Functions**

■ Pin Configuration

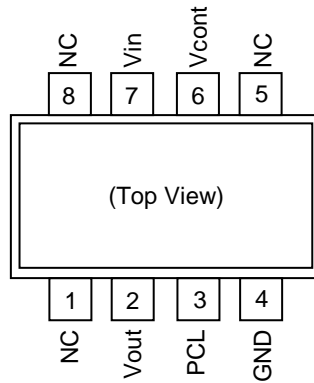

■ Functions

Pin No.	Pin Description	Internal Equivalent Circuit	Description
3	PCL		<p>Programmable Current Limitation</p> <p>The output limitation current can be set by an external resistance (<math>R_{PCL}</math>). The <math>R_{PCL}</math> is connected between the PCL terminal and GND. If there is no need of setting a current limit, connect the PCL terminal to GND.</p>
2	Vout		<p>Output Terminal</p> <p>Connect a capacitor between the Vout terminal and GND as follows.</p> <p><math>V_{out} \geq 2.4V</math>: Capacitance <math>\geq 1\mu F</math>  <math>V_{out} &lt; 2.4V</math>: Capacitance <math>\geq 2.2\mu F</math></p>
4	GND	-	GND Terminal
6	Vcont		<p>On/Off Control Terminal</p> <p>The On/Off voltages are as follows:  <math>V_{Cont} \geq 1.8V</math> : ON  <math>V_{Cont} \leq 0.35V</math> : OFF</p> <p>Pull-down resistance (500kΩ) is built-in.</p>
7	Vin	-	<p>Input Terminal</p> <p>Connect a capacitor of 1.0μF or higher between the Vin terminal and GND.</p>

### 8. Absolute Maximum Rating

Parameter	Symbol	min	max	Unit	Condition
Supply Voltage	$V_{CC_{MAX}}$	-0.4	16	V	
Reverse Bias	$V_{rev_{MAX}}$	-0.4	6	V	$V_{out} \leq 2.0V$
		-0.4	10	V	$2.1V \leq V_{out}$
PCL Terminal Voltage	$V_{pcl_{MAX}}$	-0.4	5	V	
Vcont Terminal Voltage	$V_{cont_{MAX}}$	-0.4	16	V	
Junction temperature	$T_j$	-	150	°C	
Storage Temperature Range	$T_{stg}$	-55	150	°C	
Power Dissipation	$P_D$	-	2400	mW	When mounted on PCB (Note 1)

Note 1. Please derate 19.2mW/°C above 25°C or more. Thermal resistance ( $\theta_{JA}$ ) = 52°C/W.

WARNING: The maximum ratings are the absolute limitation values with the possibility of the IC breakage. When the operation exceeds this standard quality cannot be guaranteed.

### 9. Recommended Operating Conditions

Parameter	Symbol	min	typ	max	Unit	Condition
Operating Temperature Range	$T_a$	-40	-	85	°C	
Operating Voltage Range	$V_{OP}$	2.4	-	14	V	

## 10. Electrical Characteristics

### ■ Electrical Characteristics of Ta=Tj=25°C

The parameters with min or max values will be guaranteed at Ta=Tj=25°C.

(Vin=Vout(typ)+1V, Vcont=1.8V, Ta=Tj=25°C, unless otherwise specified.)

Parameter	Symbol	Condition	min	typ	max	Unit
Output Voltage	Vout	Iout = 5mA	(Table 2)			V
Line Regulation	LinReg	ΔV=5V, Iout=5mA	-5.0	0.0	5.0	mV
Load Regulation	LoaReg	Iout=5mA ~ 500mA	-25	-	25	mV
		Iout=5mA ~ 1000mA	-45	-	45	mV
Dropout Voltage (Note 2)	Vdrop	Iout=500mA	-	160	300	mV
		Iout=1000mA	-	300	600	mV
Maximum Output Current (Note 3)	Iout,Peak	Vout=Vout(typ) × 0.9	-	1400	-	mA
Short Circuit Current(Note 3)	ISHORT		-	1500	-	mA
Quiescent Current	Iq	Iout = 0mA	-	320	520	μA
Standby Current	Istandby	Vcont = 0V	-	0.0	0.1	μA
GND Terminal Current	Ignd	Iout=30mA	-	0.7	1.4	mA
Reverse Bias Current	Irev	Vrev=Vout(typ), Vin=0V, Vcont=0V	-	0	0.1	μA
Vcont Terminal						
Vcont Terminal Current	Icont	Vcont = 1.8V	-	5	10	μA
Vcont Terminal Voltage	Vcont	Vout ON state	1.8	-	-	V
		Vout OFF state	-	-	0.35	V

Note 2. For Vout ≤ 2.0V , no regulations.

Note 3. The maximum output current is limited by power dissipation.

#### General Note:

Parameter with only typical value is for reference only.

Table 2. Standard Voltage Version

Part Number	Output Voltage		
	min	typ	max
	V	V	V
AP1154ADL18	1.750	1.800	1.850
AP1154ADL21	2.050	2.100	2.150
AP1154ADL25	2.450	2.500	2.550
AP1154ADL30	2.950	3.000	3.050
AP1154ADL33	3.250	3.300	3.350
AP1154ADL50	4.925	5.000	5.075

### ■ Electrical Characteristics of Ta=-40°C~85°C

The parameters with min or max values will be guaranteed at Ta=Tj=-40 ~ 85°C.

(Vin=Vout(typ)+1V, Vcont=1.8V, Ta=-40 ~ 85°C, unless otherwise specified.)

Parameter	Symbol	Condition	min	typ	max	Unit
Output Voltage	Vout	Iout = 5mA	(Table 3)			V
Line Regulation	LinReg	$\Delta V=5V$ , Iout=5mA	-8.0	0.0	8.0	mV
Load Regulation	LoaReg	Iout=5mA ~ 500mA	-40	-	40	mV
		Iout=5mA ~ 1000mA	-120	-	120	mV
Dropout Voltage (Note 4)	Vdrop	Iout=500mA	-	160	385	mV
		Iout=1000mA	-	300	670	mV
Maximum Output Current (Note 5)	Iout,Peak	Vout=Vout(typ) × 0.9	-	1400	-	mA
Short Circuit Current (Note 5)	ISHORT		-	1500	-	mA
Quiescent Current	Iq	Iout = 0mA	-	320	624	μA
Standby Current	Istandby	Vcont = 0V	-	0.0	1.5	μA
GND Terminal Current	Ignd	Iout=30mA	-	0.7	1.8	mA
Reverse Bias Current	Irev	Vrev=Vout(typ), Vin=0V, Vcont=0V	-	0.0	1.5	μA
Vcont Terminal						
Vcont Terminal Current	Icont	Vcont = 1.8V	-	5	10	μA
Vcont Terminal Voltage	Vcont	Vout ON state	1.8	-	-	V
		Vout OFF state	-	-	0.35	V

Note 4. For Vout ≤ 2.0V, no regulations.

Note 5. The maximum output current is limited by power dissipation.

#### General Note:

Parameter with only typical value is for reference only.

Table 3. Standard Voltage Version

Part Number	Output Voltage		
	min	typ	max
	V	V	V
AP1154ADL18	1.720	1.800	1.880
AP1154ADL21	2.020	2.100	2.180
AP1154ADL25	2.420	2.500	2.580
AP1154ADL30	2.920	3.000	3.080
AP1154ADL33	3.217	3.300	3.383
AP1154ADL50	4.875	5.000	5.125

**11. Description**

**11.1 DC Characteristics**

■ Vout vs Vin (AP1154ADL25)

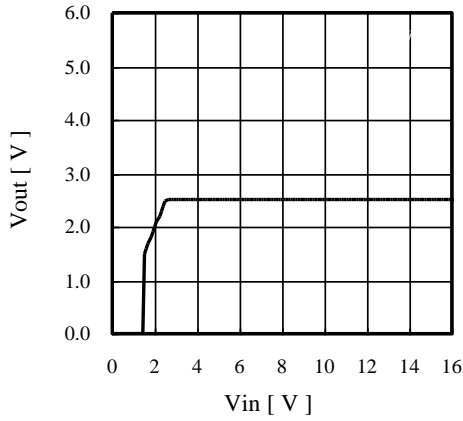

■ Vout vs Vin (AP1154ADL50)

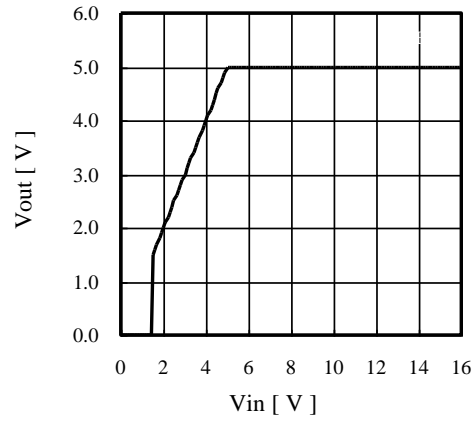

■ Line Regulation (AP1154ADL25)

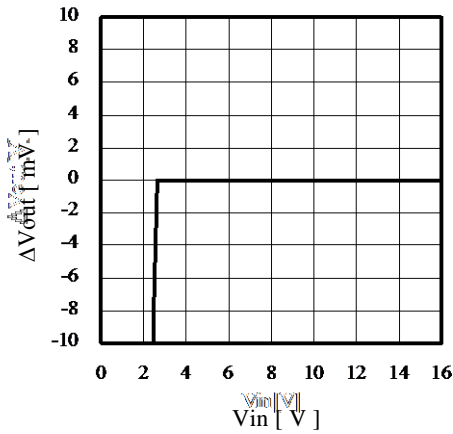

■ Line Regulation (AP1154ADL50)

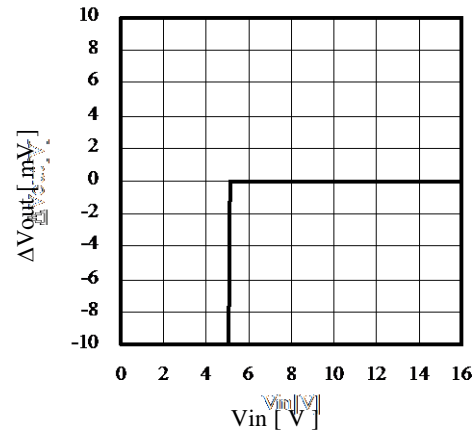

■ Iq vs Vin (AP1154ADL25)

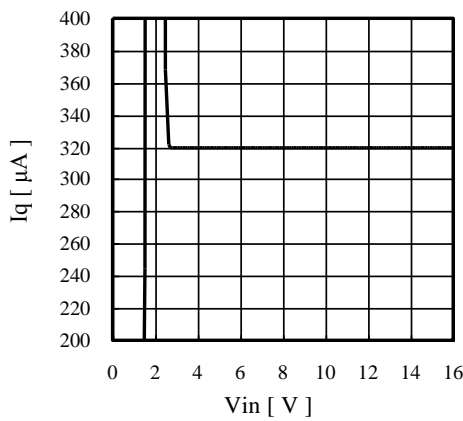

■ Iq vs Vin (AP1154ADL50)

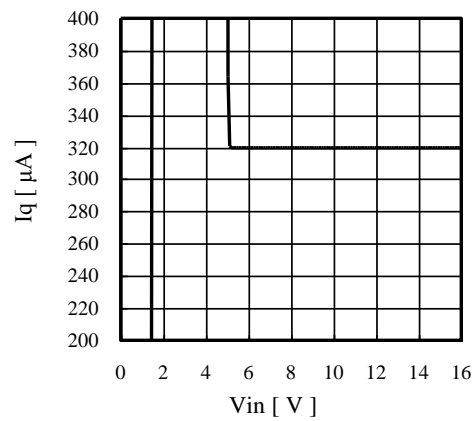



■  $I_Q$  vs  $V_{in}$  (AP1154ADL25)

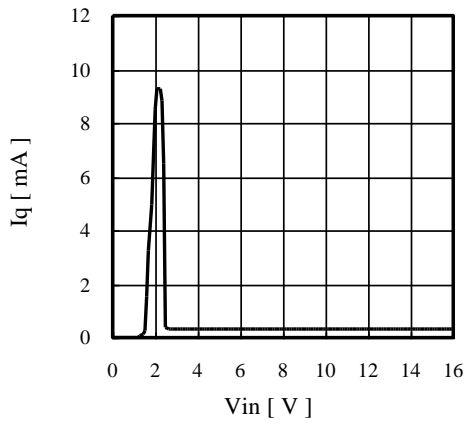

■  $I_Q$  vs  $V_{in}$  (AP1154ADL50)

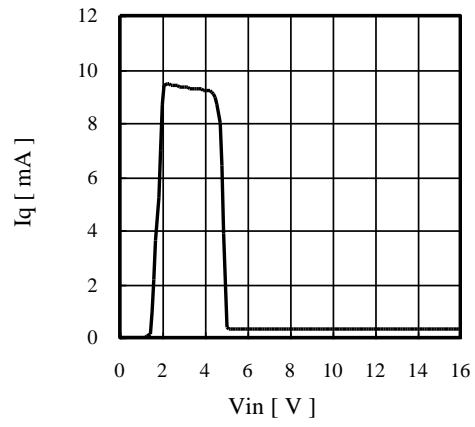

■ Load Regulation (AP1154ADL25)

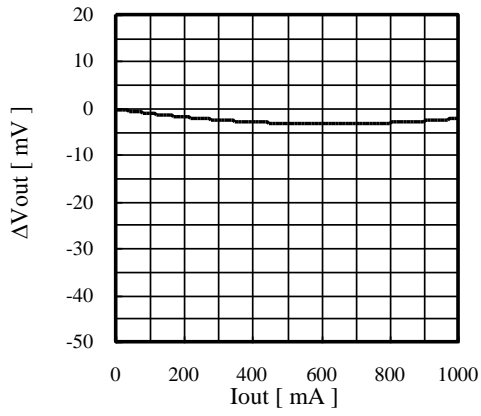

■ Load Regulation (AP1154ADL50)

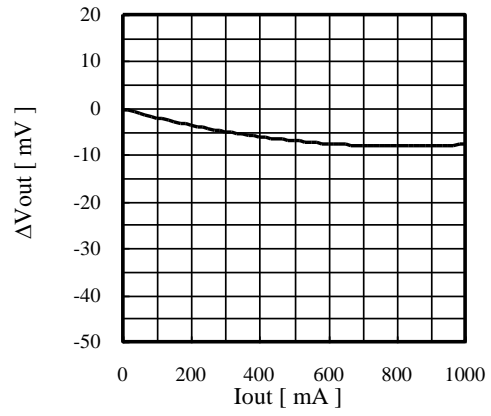

■  $I_{GND}$  vs  $I_{Out}$  (AP1154ADL25)

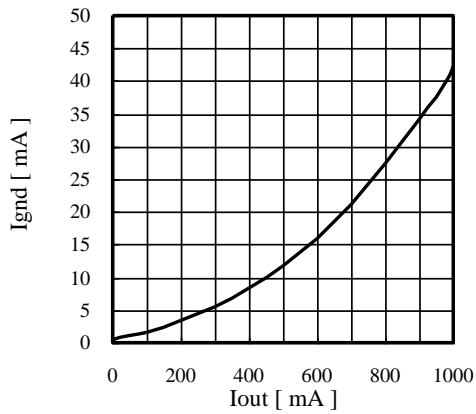

■  $I_{GND}$  vs  $I_{Out}$  (AP1154ADL50)

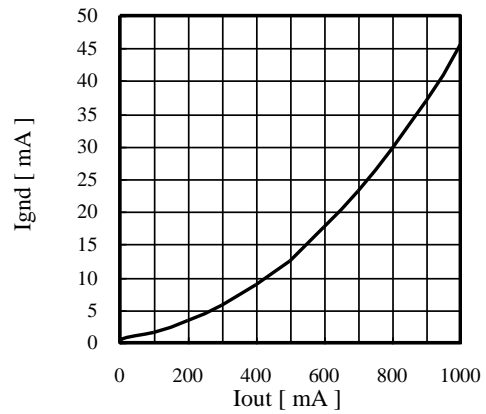

■  $V_{Drop}$  vs  $I_{Out}$  (AP1154ADL25)

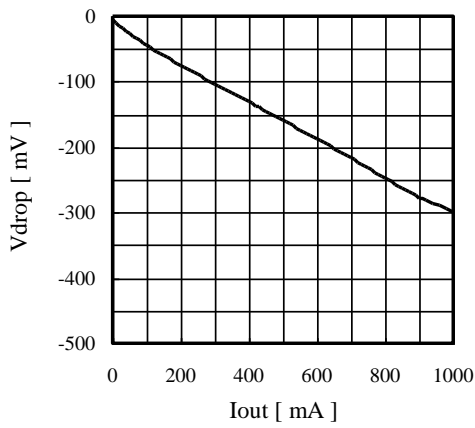

■  $V_{Drop}$  vs  $I_{Out}$  (AP1154ADL50)

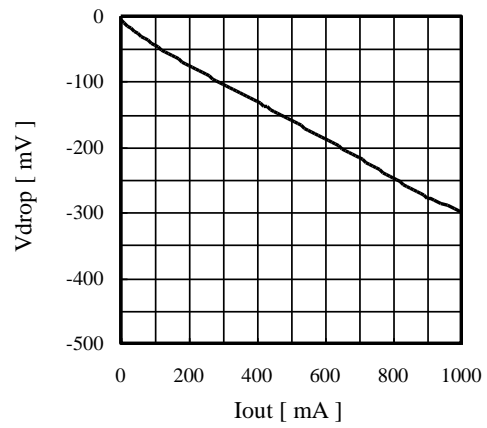

■  $V_{out}$  vs  $I_{Out}$  (AP1154ADL25)

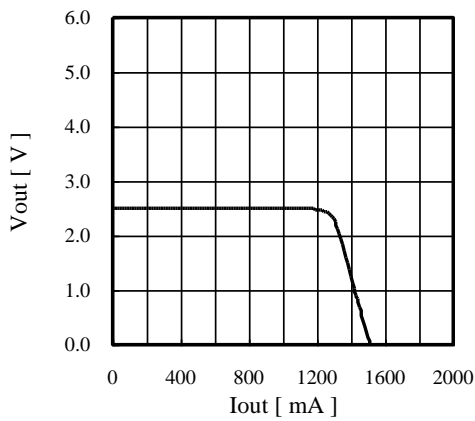

■  $V_{out}$  vs  $I_{Out}$  (AP1154ADL50)

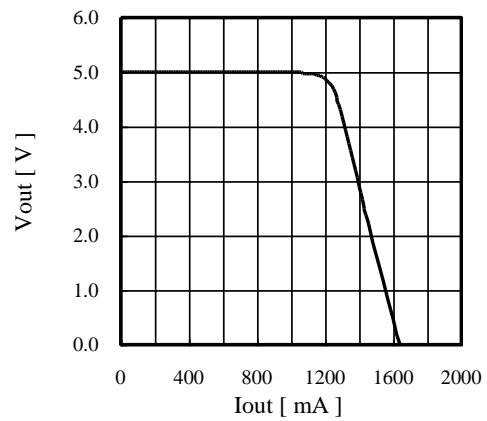

■  $\Delta V_{out}$  vs  $\Delta V_{in}$  (AP1154ADL25)

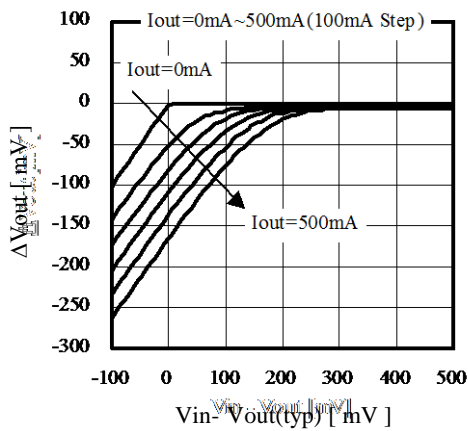

■  $\Delta V_{out}$  vs  $\Delta V_{in}$  (AP1154ADL50)

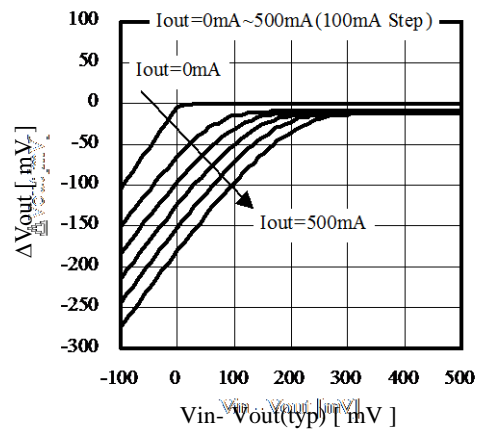

■ PCL terminal current ( $I_{PCL}$ ) vs  $I_{Out}$   
(AP1154ADL25)

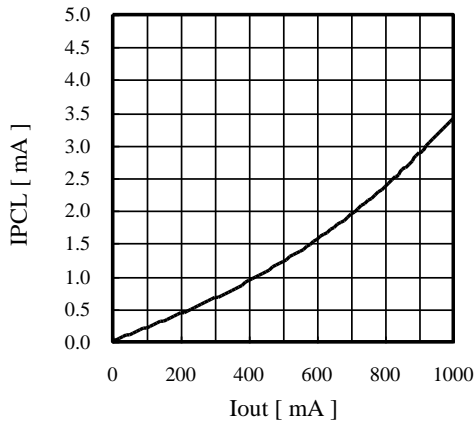

■ PCL terminal current ( $I_{PCL}$ ) vs  $I_{Out}$   
(AP1154ADL50)

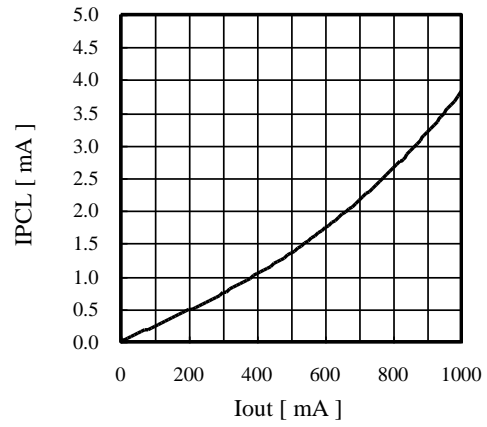

■  $I_{Cont}$  vs  $V_{Cont}$  (AP1154ADL25)

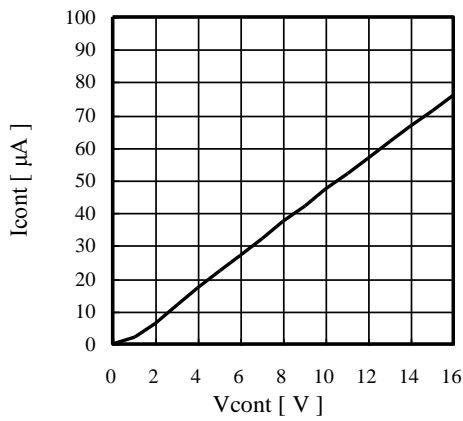

■  $I_{Cont}$  vs  $V_{Cont}$  (AP1154ADL50)

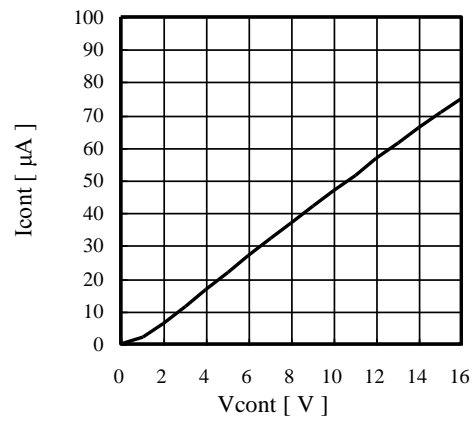

■  $V_{out}$  vs  $V_{Cont}$  (AP1154ADL25)

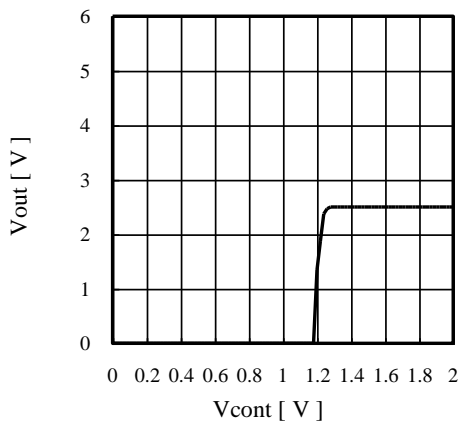

■  $V_{out}$  vs  $V_{Cont}$  (AP1154ADL50)

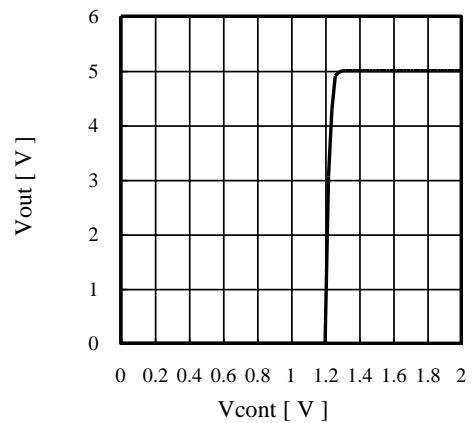

■  $I_{Standby}$  vs  $V_{in}$  (AP1154ADL25)

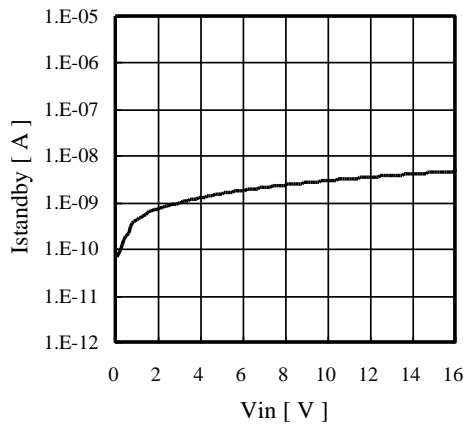

■  $I_{Standby}$  vs  $V_{in}$  (AP1154ADL50)

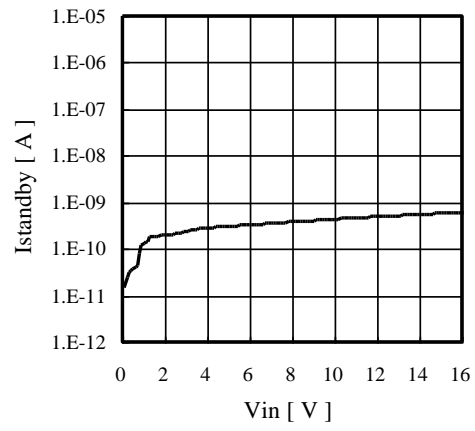

■  $I_{Rev}$  vs  $V_{Rev}$  (AP1154ADL25)

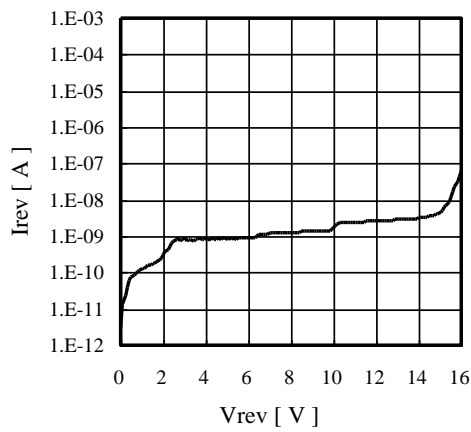

■  $I_{Rev}$  vs  $V_{Rev}$  (AP1154ADL50)

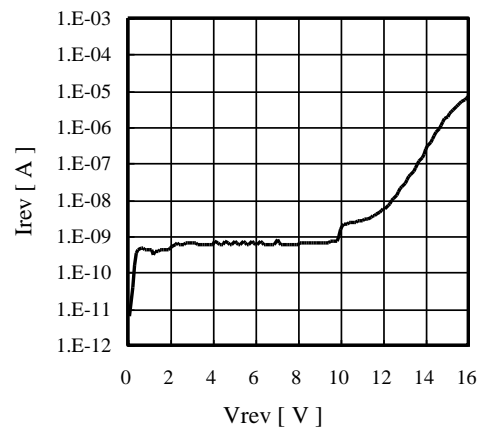

• Temperature Characteristics

■  $\Delta V_{out}$  vs  $T_a$  (AP1154ADL25)

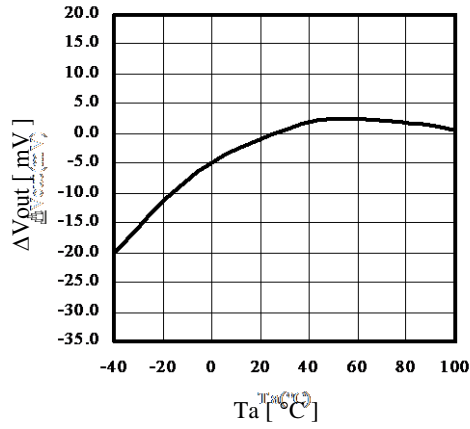

■  $\Delta V_{out}$  vs  $T_a$  (AP1154ADL50)

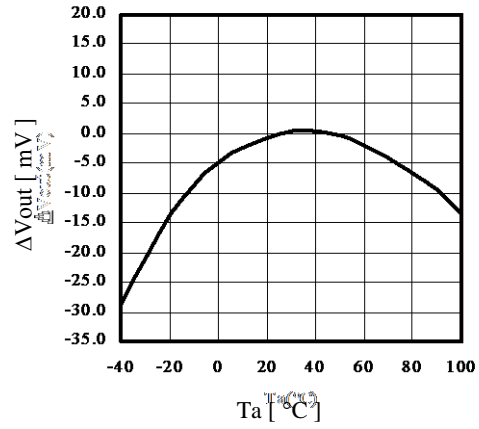

■  $I_Q$  vs  $T_a$  (AP1154ADL25)

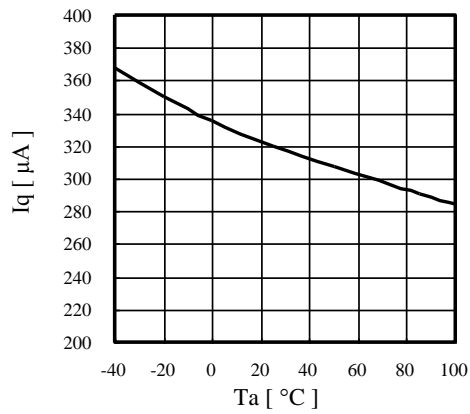

■  $I_Q$  vs  $T_a$  (AP1154ADL50)

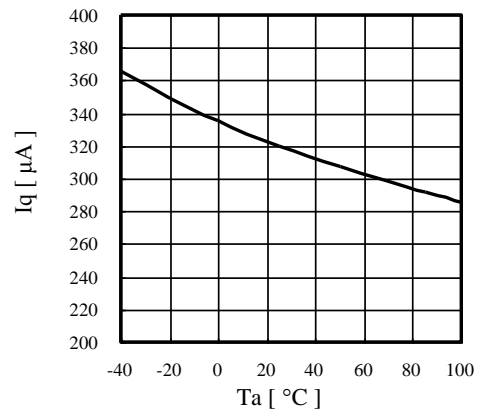

■  $LoaReg$  vs  $T_a$  (AP1154ADL25)

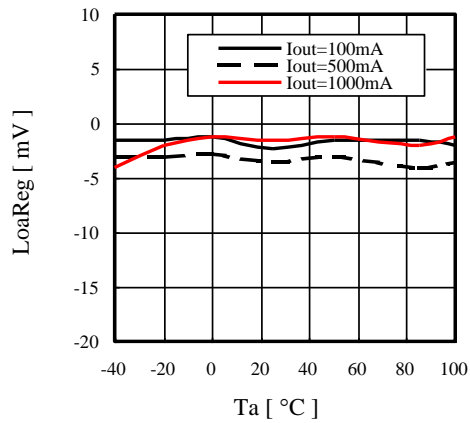

■  $LoaReg$  vs  $T_a$  (AP1154ADL50)

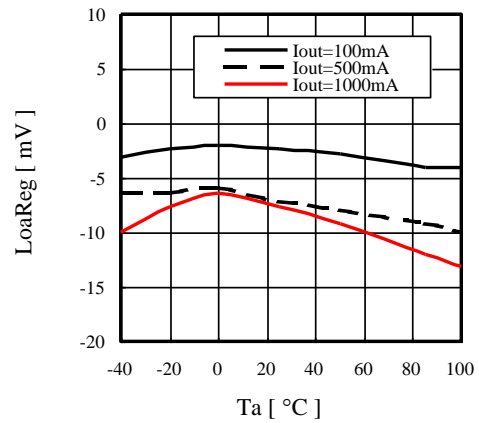

■  $I_{GND}$  vs  $T_a$  (AP1154ADL25)

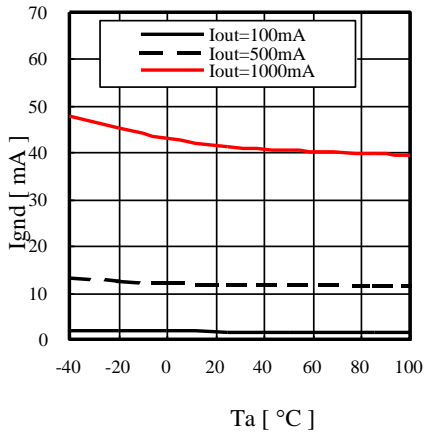

■  $I_{GND}$  vs  $T_a$  (AP1154ADL50)

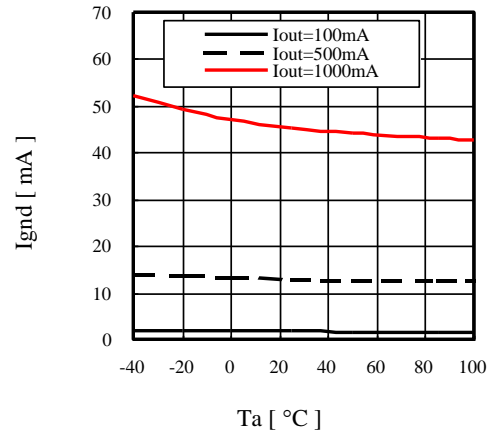

■  $V_{Drop}$  vs  $T_a$  (AP1154ADL25)

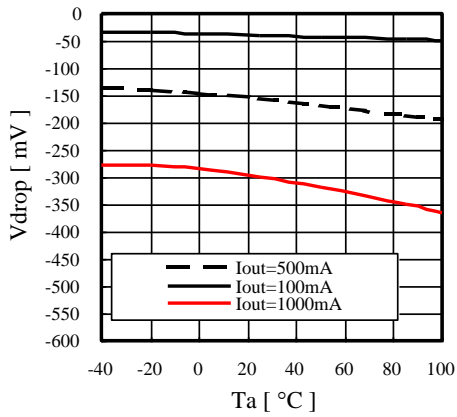

■  $V_{Drop}$  vs  $T_a$  (AP1154ADL50)

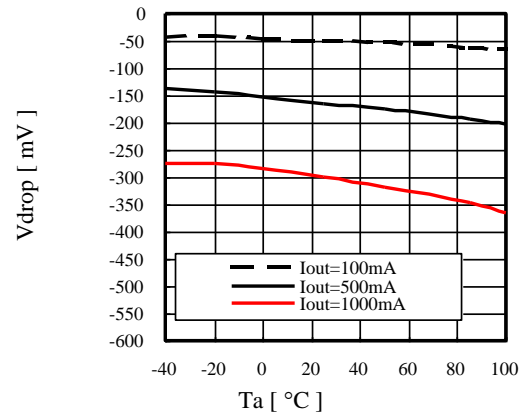

■  $I_{Out,MAX}$  vs  $T_a$  (AP1154ADL25)

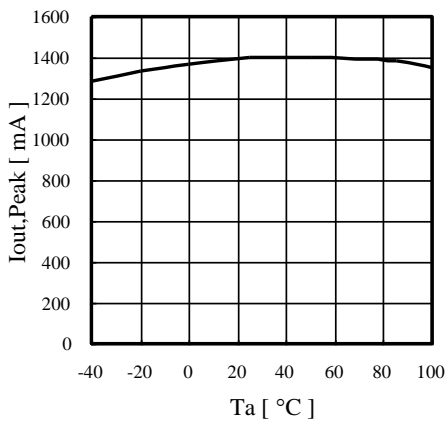

■  $I_{Out,MAX}$  vs  $T_a$  (AP1154ADL50)

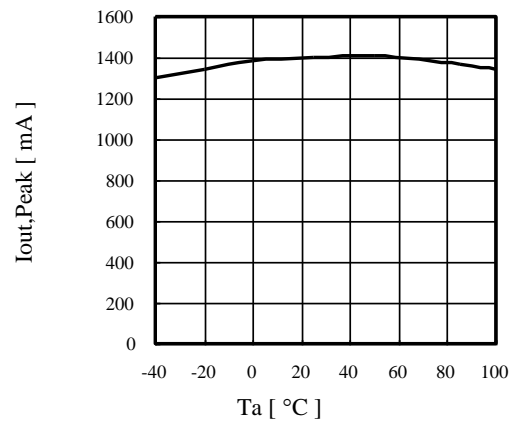

■  $I_{PCL}$  vs  $T_a$  (AP1154ADL25)

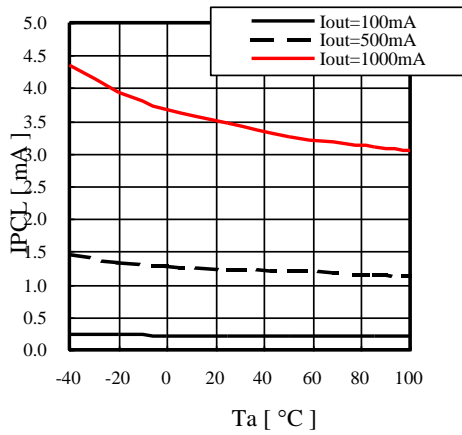

■  $I_{PCL}$  vs  $T_a$  (AP1154ADL50)

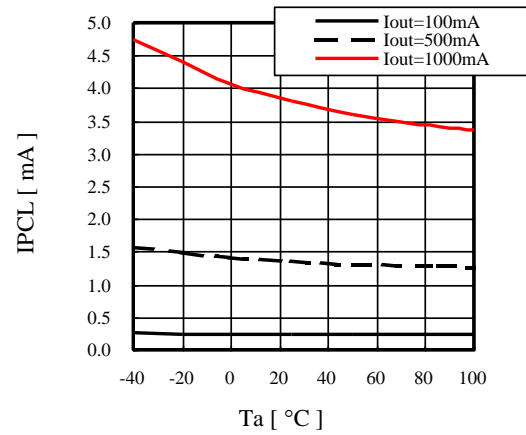

■  $I_{Cont}$  vs  $T_a$  (AP1154ADL25) ( $V_{cont}=1.8V$ )

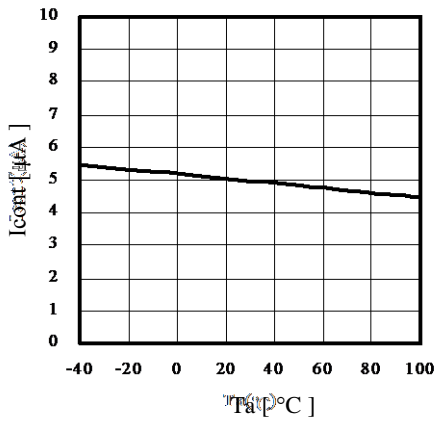

■  $I_{Cont}$  vs  $T_a$  (AP1154ADL50) ( $V_{cont}=1.8V$ )

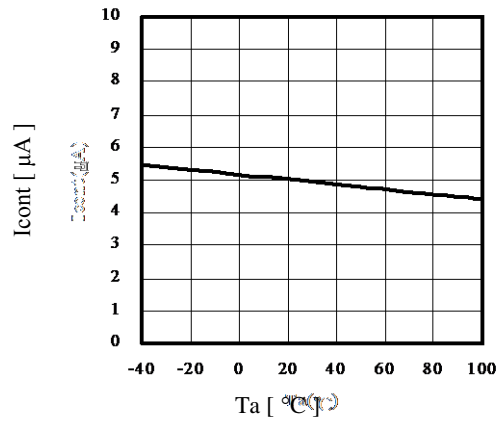

■  $V_{out}$  On/Off Point vs  $T_a$  (AP1154ADL25)

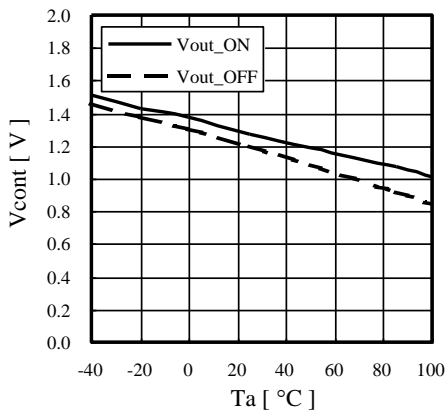

■  $V_{out}$  On/Off Point vs  $T_a$  (AP1154ADL50)

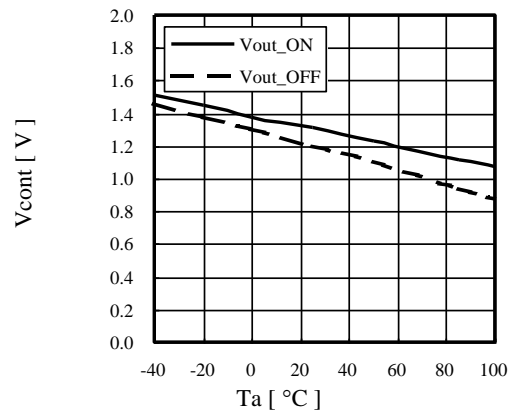

### 11.2 ON/OFF Transient

Measurement circuit

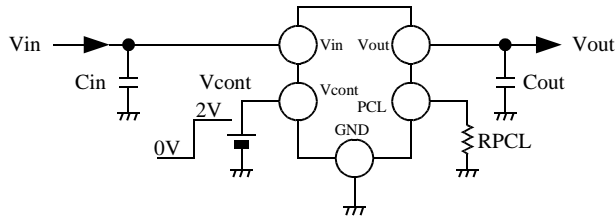

Measurement Condition

$V_{in} = V_{out}(typ) + 1V$   
 $V_{cont} = 0V \rightarrow 2V (f = 10Hz)$   
 $I_{out} = 1000mA$   
 $C_{in} = 1\mu F$   
 $C_{out} = 1\mu F$   
 $R_{PCL} = 0\Omega$

■ AP1154ADL25  $C_{out} : 1\mu F, 10\mu F$

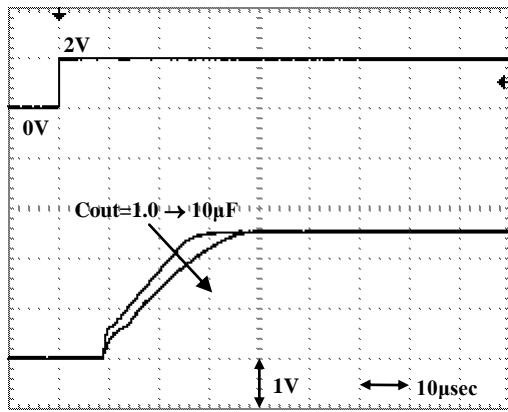

Vertical axis:1V/Div, Horizontal axis:10µsec/Div

■ AP1154ADL25

$R_{PCL} : 0\Omega \sim 10k\Omega, I_{out}=50mA$

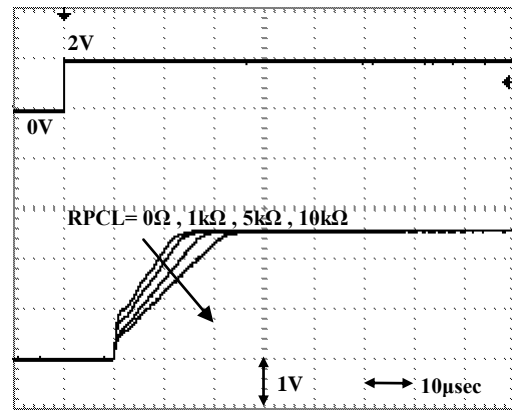

Vertical axis:1V/Div, Horizontal axis:10µsec/Div

■ AP1154ADL50  $C_{out} : 1\mu F, 10\mu F$

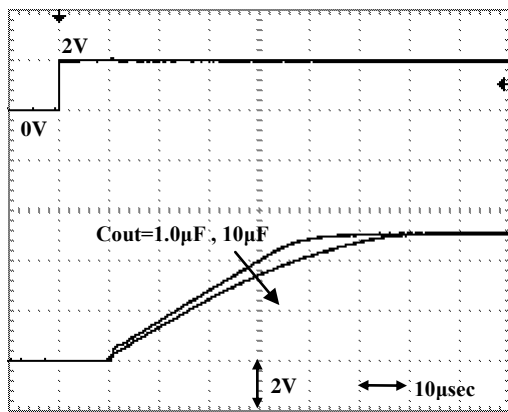

Vertical axis:1V/Div, Horizontal axis:10µsec/Div

■ AP1154ADL50

$R_{PCL} : 0\Omega \sim 10k\Omega, I_{out}=50mA$

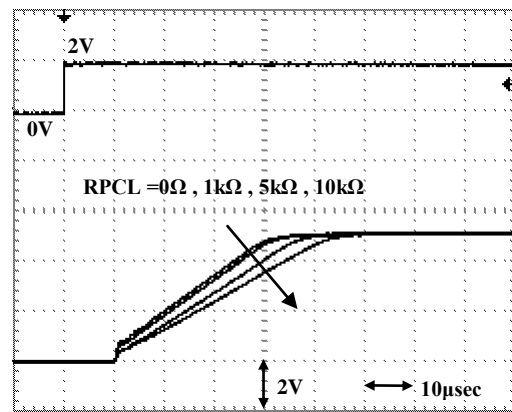

Vertical axis:1V/Div, Horizontal axis:10µsec/Div



### 11.3 Line transient

#### Measurement circuit

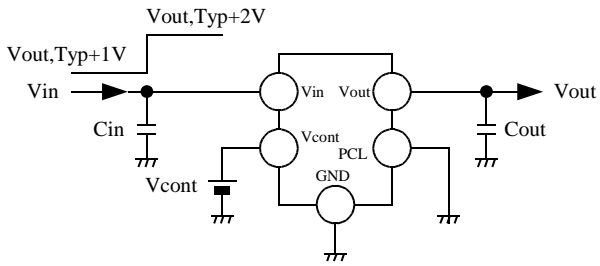

#### Measurement condition

$V_{in} = V_{out}(typ) + 1V \rightarrow V_{out}(typ) + 2V$  (  $f = 1kHz$  )  
 $V_{cont} = 2V$   
 $C_{in} = 1\mu F$   
 $C_{out} = 1\mu F$   
 $RPCL = 0\Omega$

#### ■ AP1154ADL25

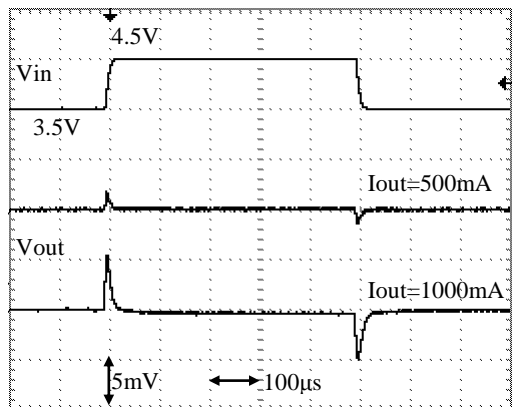

Vertical axis: 5mV/Div, Horizontal axis:100µsec/Div

#### ■ AP1154ADL50

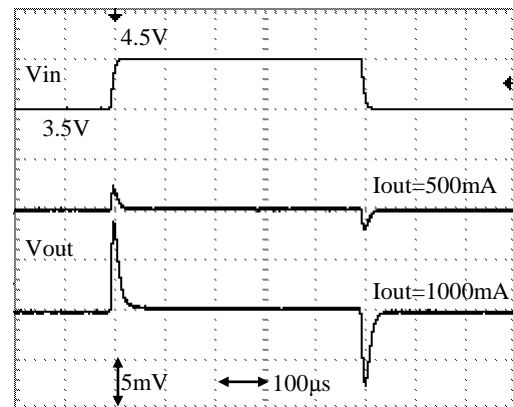

Vertical axis: 5mV/Div, Horizontal axis:100µsec/Div

### 11.4 Load transient

#### Measurement circuit

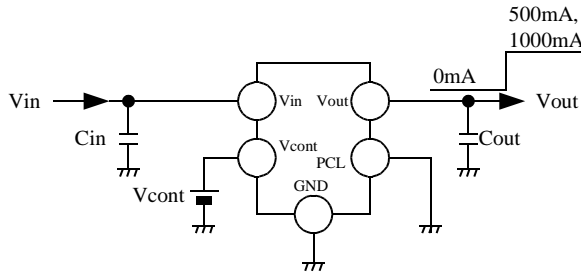

#### Measurement condition

$V_{in} = V_{out}(typ) + 1V$   
 $V_{cont} = 2V$   
 $C_{in} = 1\mu F$   
 $C_{out} = 1\mu F$   
 $R_{PCL} = 0\Omega$

■AP1154ADL25  
 $I_{out}: 0A \rightarrow 500mA, 1000mA$  (Freq=10Hz)

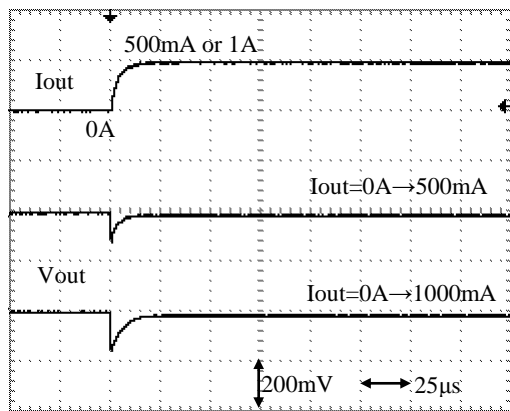

Vertical axis: 200mV/Div, Horizontal axis: 25μsec/Div

■AP1154ADL25  
 $I_{out}: 500mA, 1000mA \rightarrow 0A$  (Freq=10Hz)

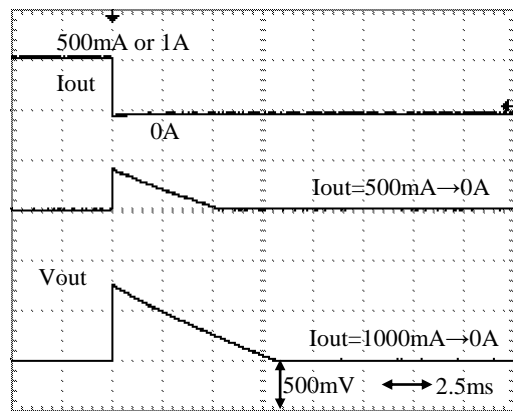

Vertical axis: 500mV/Div, Horizontal axis: 2.5msec/Div

■AP1154ADL50  
 $I_{out}: 0A \rightarrow 500mA, 1000mA$  (Freq=10Hz)

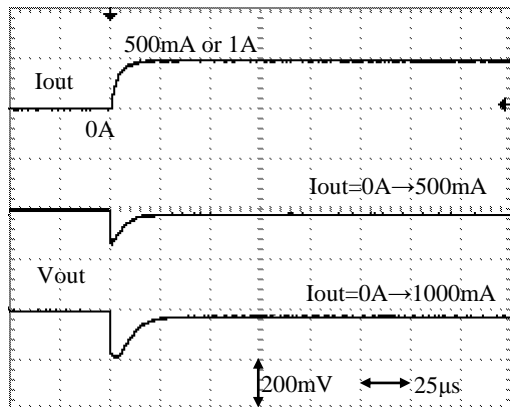

Vertical axis: 200mV/Div, Horizontal axis: 25μsec/Div

■AP1154ADL50  
 $I_{out}: 500mA, 1000mA \rightarrow 0A$  (Freq=10Hz)

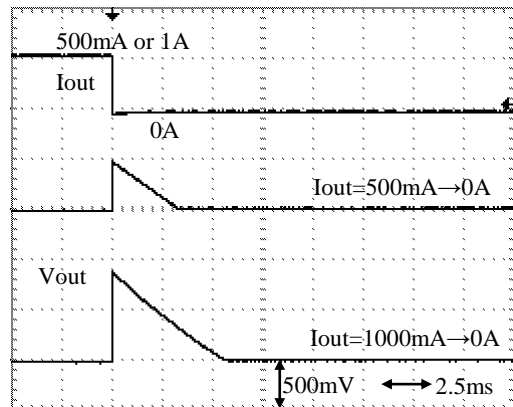

Vertical axis: 500mV/Div, Horizontal axis: 2.5msec/Div

■AP1154ADL25

Iout:10mA→500mA→10mA(Freq=5kHz)

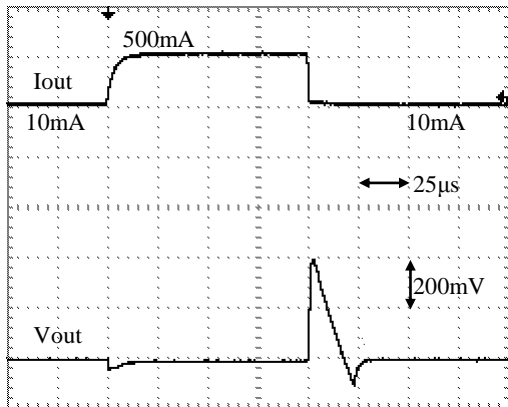

Vertical axis: 200mV/Div, Horizontal axis:25µsec/Div

■AP1154ADL25

Iout:10mA→1000mA→10mA(Freq=5kHz)

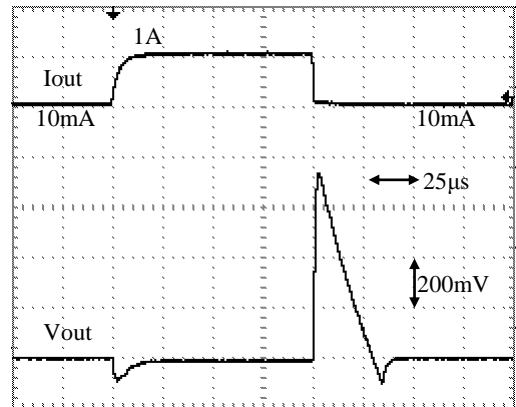

Vertical axis: 200mV/Div, Horizontal axis:25µsec/Div

■AP1154ADL50

Iout:10mA→500mA→10mA(Freq=5kHz)

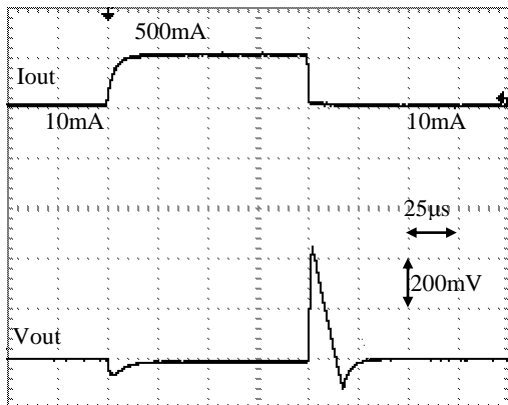

Vertical axis:200mV/Div, Horizontal axis:25µsec/Div

■AP1154ADL50

Iout:10mA→1000mA→10mA(Freq=5kHz)

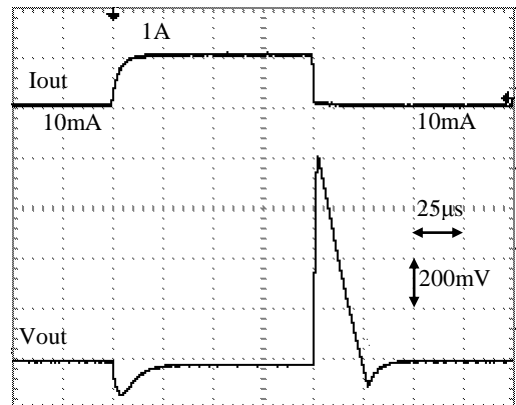

Vertical axis:200mV/Div, Horizontal axis:25µsec/Div

### 11.5 Ripple Rejection

Measurement circuit

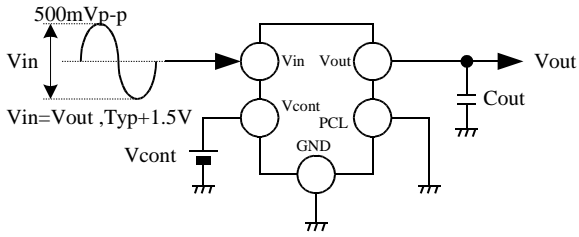

Measurement condition

$V_{in} = V_{out(typ)} + 1.5V$   
 Ripple Noise = 500mVp-p ( f = 1kHz , Sine wave )  
 $V_{cont} = 2V$   
 $I_{out} = 100mA$   
 $C_{in} : \text{None}$   
 $C_{out} = 1\mu F$   
 $RPCL = 0\Omega$

■AP1154ADL25  $I_{out} = 100mA \sim 1A$

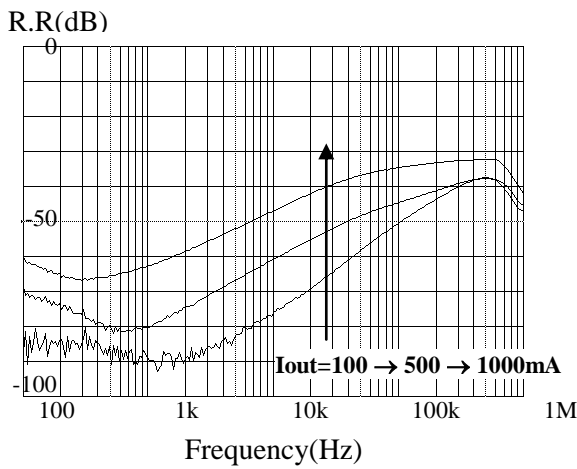

■AP1154ADL25  $C_{out} = 1.0\mu F \sim 10\mu F$

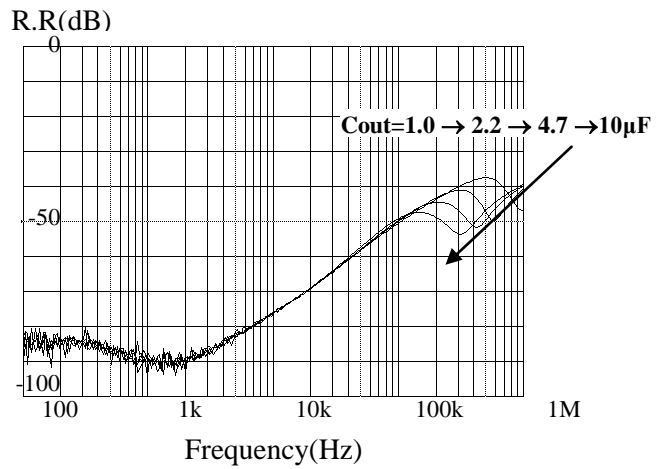

■AP1154ADL50  $I_{out} = 100mA \sim 1A$

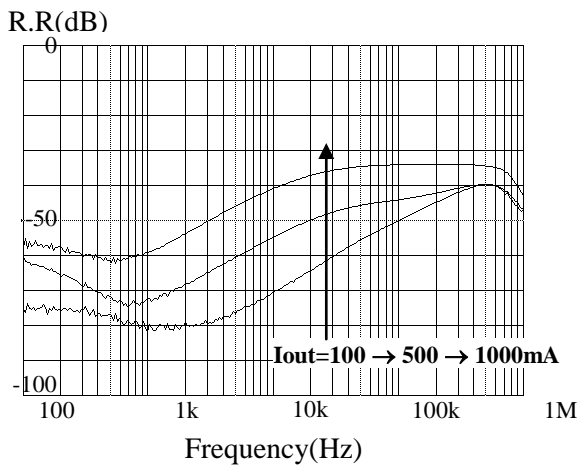

■AP1154ADL50  $C_{out} = 1.0\mu F \sim 10\mu F$

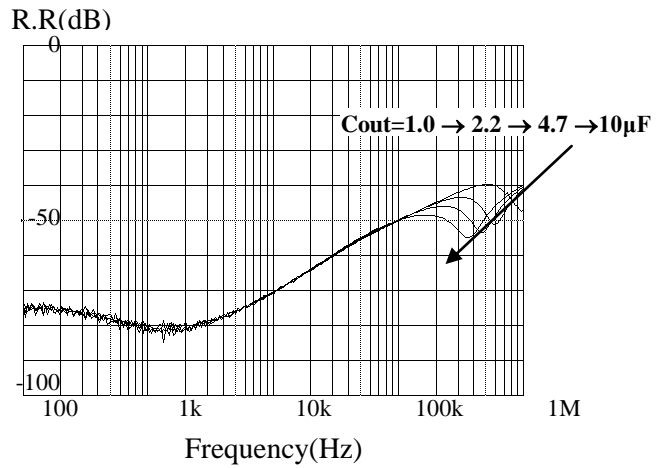

■AP1154ADL25 Iout=1mA~1A , f=1kHz

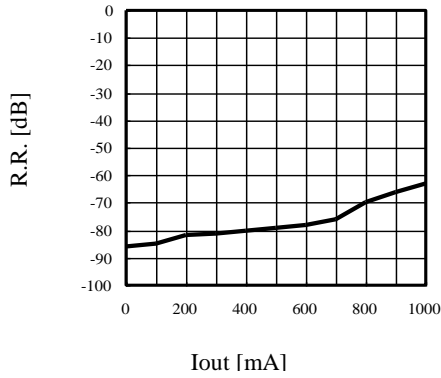

■AP1154ADL50 Iout=1mA~1A , f=1kHz

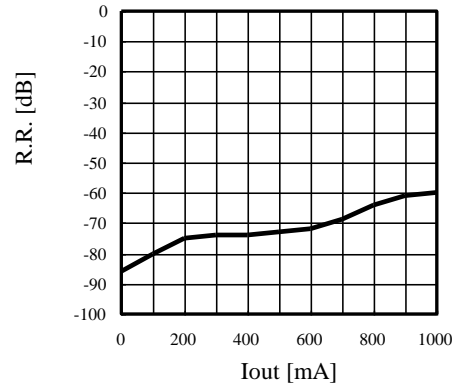

### 11.6 Output Noise

Measurement circuit

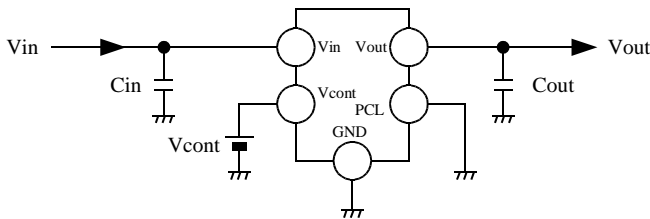

Measurement condition

- Vin = Vout(typ) + 1V
- Vcont = 2V
- Cin = 1μF
- Cout = 1μF
- RPCL = 0Ω

■AP1154ADL25 (f = 10 ~ 100kHz)

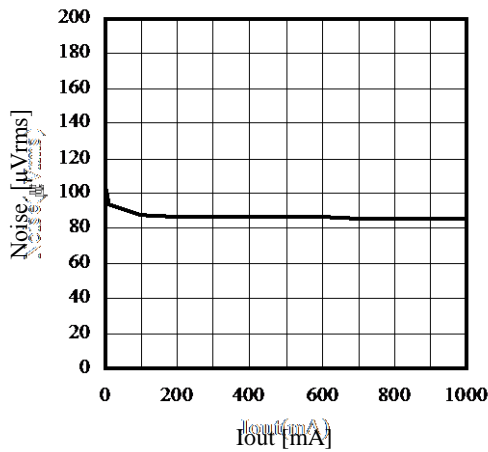

■AP1154ADL50 (f = 10 ~ 100kHz)

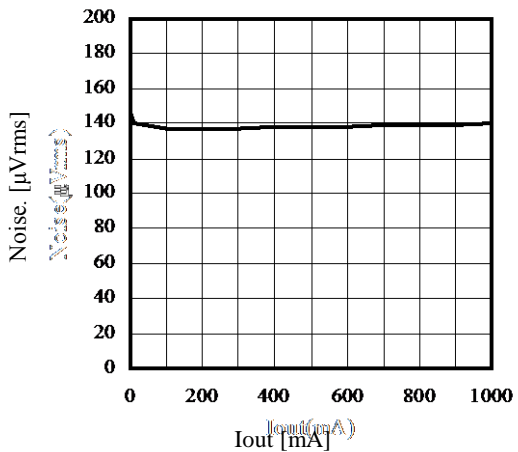

### 11.7 Setting of output current limitation

The output current limit can be set by connecting an external resistance ( $R_{PCL}$ ) between the PCL terminal and GND. If there is no need of setting a current limit, connect the PCL terminal to GND

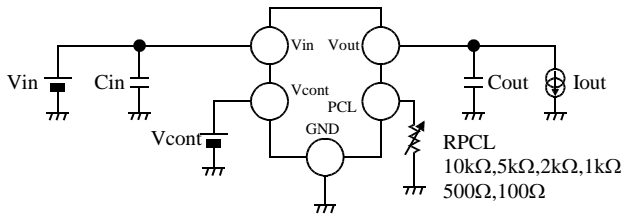

■ AP1154ADL50 Iout,Peak vs Iout with  $R_{PCL}$

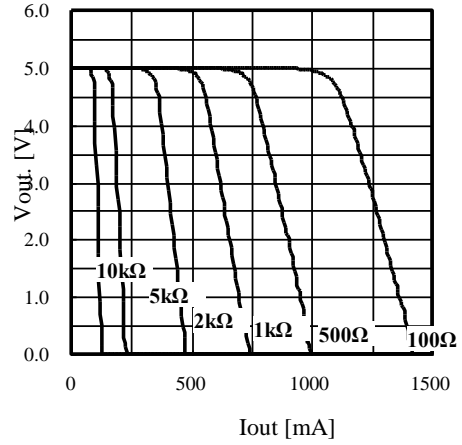

The below figures show relation between  $R_{PCL}$  value and  $I_{out,Peak}$  at  $V_{in}=V_{out}(typ)+1V$ ,  $T_a=25^{\circ}C$

■ AP1154ADL25 Iout,Peak vs  $R_{PCL}$

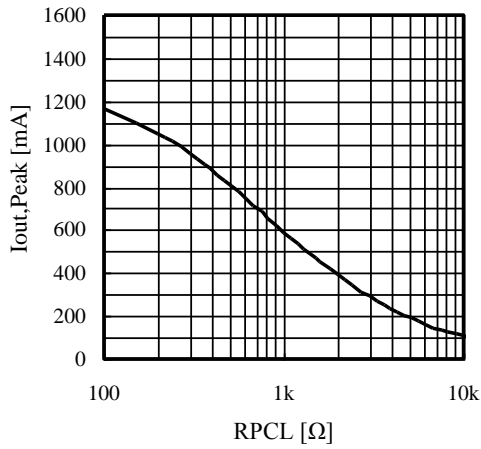

■ AP1154ADL50 Iout,Peak vs  $R_{PCL}$

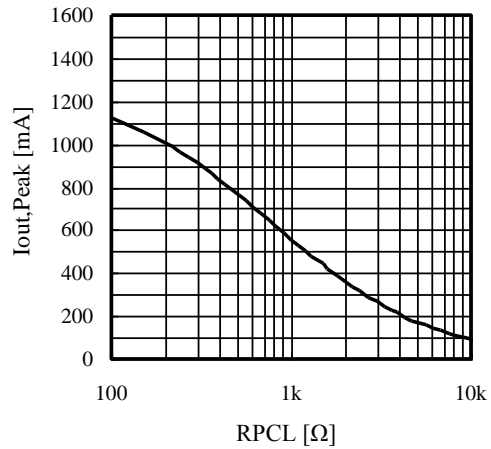

\*  $I_{out,Peak}$  : Output current at 10% drop from typical output voltage.

Relation between  $R_{PCL}$  and  $I_{out,Peak}$  has variation based on the supply voltage and the ambient temperature. Please ensure the suitable value on the environment.

■ AP1154ADL25  $I_{out,Peak}$  vs  $R_{PCL}$  with  $V_{in}$

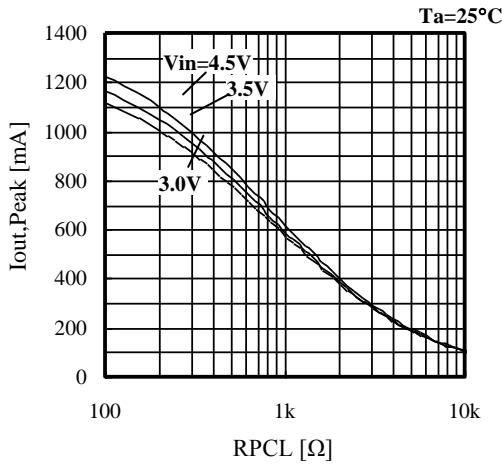

■ AP1154ADL50  $I_{out,Peak}$  vs  $R_{PCL}$  with  $V_{in}$

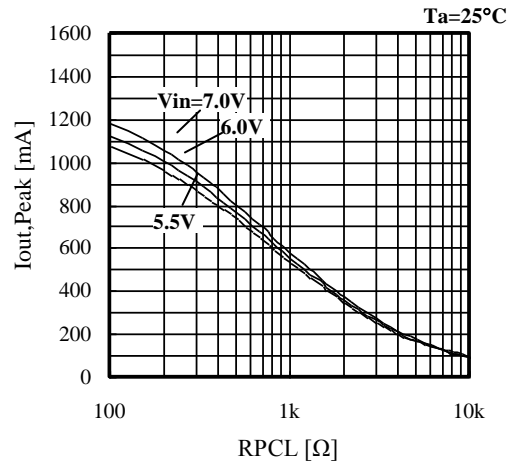

■ AP1154ADL25  $I_{out,Peak}$  vs  $R_{PCL}$  with  $T_a$

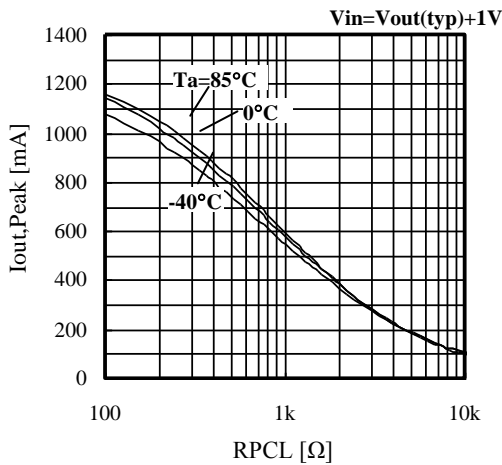

■ AP1154ADL50  $I_{out,Peak}$  vs  $R_{PCL}$  with  $T_a$

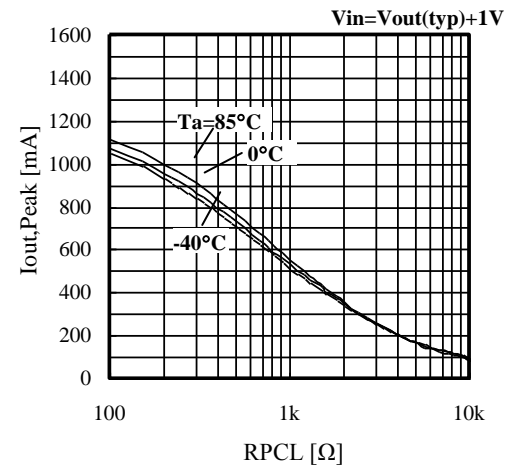

■ AP1154ADL25  $I_{out,Peak}$  vs  $T_a$  with  $R_{PCL}$

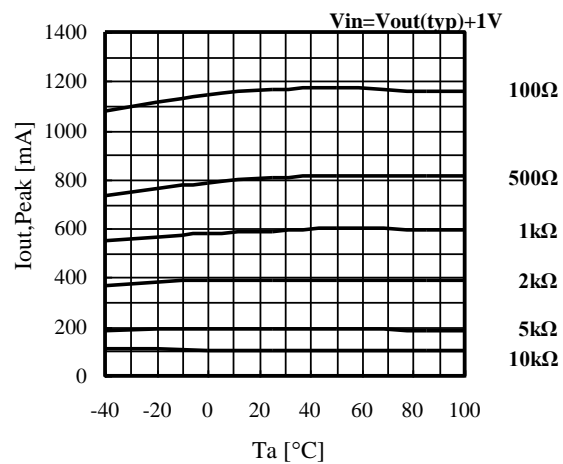

■ AP1154ADL50  $I_{out,Peak}$  vs  $T_a$  with  $R_{PCL}$

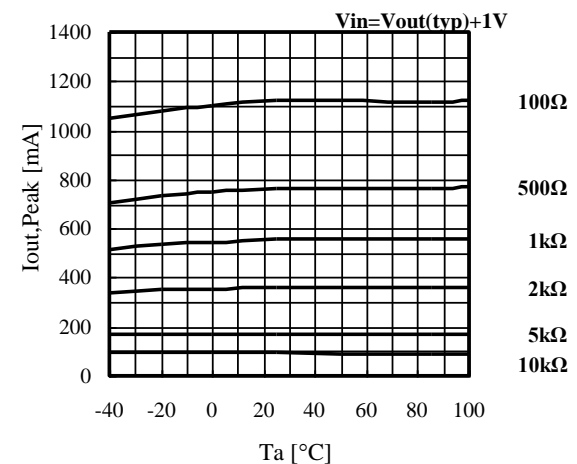

### 11.8 Stability

The standard capacitor recommended for use on the output side is a ceramic capacitor equal to or greater than 1.0μF. For operations at 2.4V or less, use at least a 2.2μF capacitor.

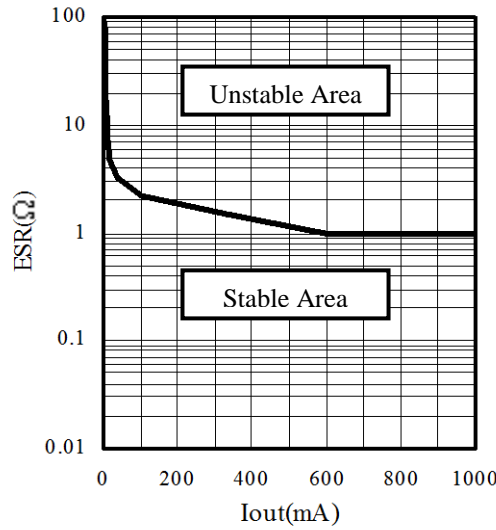

Figure 2. Stable operation area (C<sub>Out</sub> ≥ 0.47 μF)

Figure 2 indicates that operation is stable in the entire current range with a resistance of 1Ω or less (equivalent series resistance or ‘ESR’) connected in series to the output capacitor. Generally, the ESR of a ceramic capacitor is very low (several tens of mΩ), and no problems should arise in actual use. If an application requires use of a large ESR capacitor, connecting a ceramic capacitor with low ESR in parallel will enable operations at this level. When parallel output capacitors are used, be sure to position the ceramic capacitor as close to the IC as possible. The other capacitor connected in parallel may be located away from the IC. The IC will not be damaged by the increased capacitance.

Input capacitors are necessary when the power supply impedance increases due to battery depletion or when the line to the power supply is particularly long. There is no general rule that can be used to determine the required number of capacitors used for such purposes. In some cases, only one capacitor is necessary for several regulator ICs. In some cases, one capacitor is required for each IC. To determine the required number of capacitors in a specific application, be sure to verify operation with all parts in the installed configuration. Ceramic capacitors normally have specific temperature and voltage characteristics. Be sure to take the operating voltage and temperature into consideration when selecting parts for use. We recommend parts featuring B characteristics.

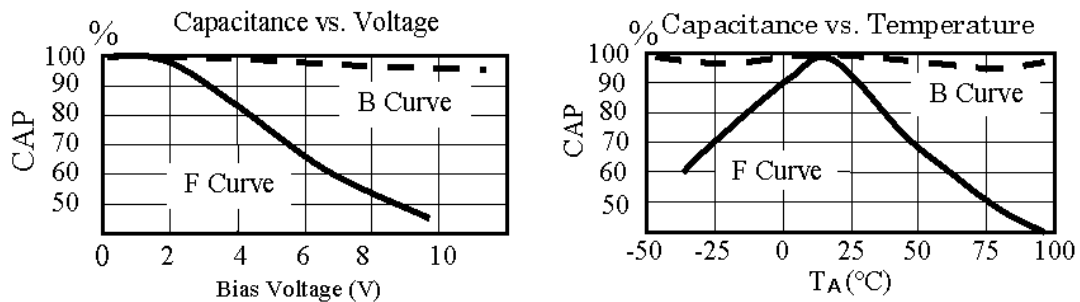

Figure 3. Example Ceramic Capacitance vs. Bias Voltage, Temperature

For evaluation

Kyocera : CM05B104K10AB , CM05B224K10AB , CM105B104K16A , CM105B224K16A , CM21B225K10A

Murata : GRM36B104K10 , GRM42B104K10 , GRM39B104K25 , GRM39B224K10 , GRM39B105K6.3



### 11.9 Operating Region and Power Dissipation

Power dissipation capability is limited by the junction temperature that triggers the built-in overheat protection circuit. Therefore, power dissipation capability is regarded as an internal limitation. The package itself does not offer high heat dissipation because of its small size. The package is, however, designed to release heat effectively when mounted on the PCB. Therefore, the heat-dissipation value will vary depending on the material, copper pattern, etc. of the PCB on which the package is mounted.

When the regulator loss is large (high ambient temperature, poor heat radiation), the overheat protection circuit is activated. When this occurs, output current cannot be obtained, and an output voltage drop is observed. When the junction temperature reaches the set value, the IC stops operating. However, after the IC has stopped operation and the junction temperature lowers sufficiently, the IC restarts operation immediately.

#### The thermal resistance when mounted on PCB

The chip junction temperature during operation is expressed by

$$T_j = \theta_{ja} \times P_D + T_a$$

The junction temperature of the AP1154ADLxx is limited to approximately 145°C by the overheat protection circuit.  $P_D$  is the value observed when the overheat protection circuit is activated. The following example is based on an ambient temperature of 25°C.

$$145 = \theta_{ja} \times P_D + 25$$

$$\theta_{ja} \times P_D = 120$$

$$\theta_{ja} = \frac{120}{P_D} \text{ (}^\circ\text{C/W)}$$

Glass epoxy substrate with double-layer wiring

(x=30mm, y=30mm, t=1.0mm, copper pattern thickness: 35μm)

#### AP1154ADLXX (HSOP-8)

$P_D$  is 2400mW. If the temperature exceeds 25°C, be sure to derate at -20mW/°C.

#### Method of obtaining $P_D$ easily

With the output terminal shorted-circuited to GND, gradually increase the input voltage and measure the input current. Slowly increase the input voltage to about 10V. The initial input current value becomes the maximum instantaneous output current value, but gradually lowers as the chip temperature rises, and ultimately reaches a state of thermal equilibrium (through natural air cooling).

$P_D$  is calculated using the input value for input current and the input voltage value in the equilibrium state.

$$P_D \cong V_{in} \times I_{in}$$

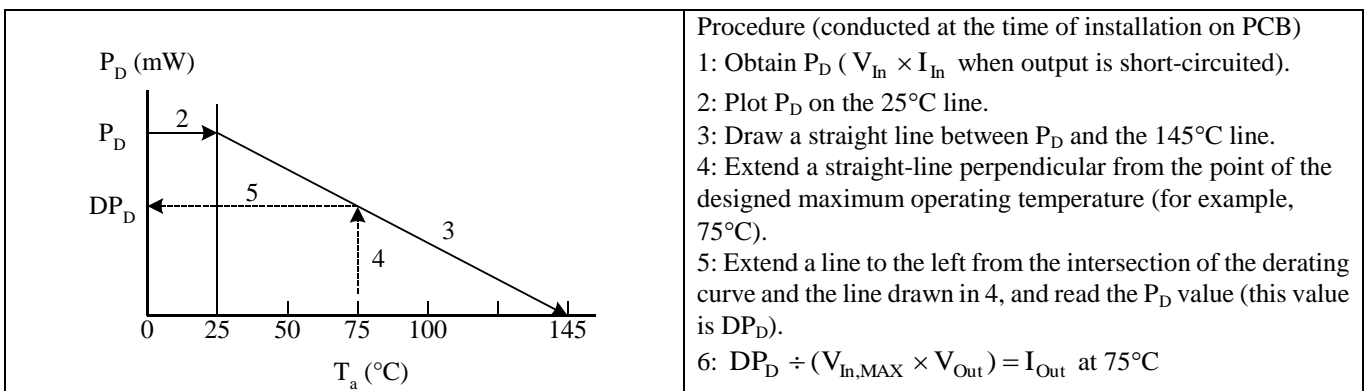

The maximum operating current at the maximum temperature is as follows:

$$I_{Out} \cong \{DP_D \div (V_{in,MAX} - V_{Out})\}$$

Try to achieve maximum heat dissipation in your design in order to minimize the part's temperature during operation. Generally, lower part temperatures result in higher reliability in operation.

### 11.10 Operating Region and Power Dissipation

It is recommended to turn the regulator off when the circuit following the regulator is not operating. A design with small electric power loss can be implemented. Because the V<sub>cont</sub> terminal current is small, it is possible to control it directly by CMOS logic.

V <sub>cont</sub> Terminal Voltage	ON/OFF State
V <sub>cont</sub> > 1.8V	ON
V <sub>cont</sub> < 0.35V	OFF

#### Parallel Connected ON/OFF Control

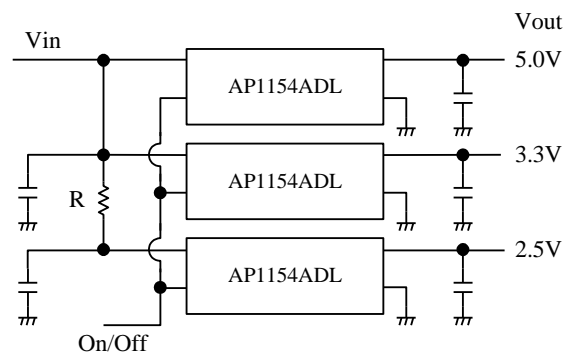

Figure 4. Parallel Connection Example

Figure 4 shows the multiple regulators being controlled by a single ON/OFF control signal. There is fear of overheating, because the power loss of the low voltage side (AP1154ADL20) is large. The series resistor (R) is put in the input line of the low output voltage regulator in order to prevent over-dissipation. The voltage dropped across the resistor reduces the large input-to-output voltage across the regulator, reducing the power dissipation in the device. When the thermal sensor works, a decrease of the output voltage, oscillation, etc. may be observed.

## 12. Definition of term

### Characteristics

#### ■ Output Voltage ( $V_{out}$ )

The output voltage is specified with  $V_{in}=V_{out}(typ)+1V$  and  $I_{Out}=5mA$ .

#### ■ Output Current ( $I_{Out}$ )

Output current, which can be used continuously (It is the range where overheating protection of the IC does not operate).

#### ■ Maximum output current ( $I_{Out,Peak}$ )

The rated output current is specified under the condition where the output voltage drops 0.9V times the value specified with  $I_{Out}=5mA$  by increasing the output current. The input voltage is set to  $V_{out}(typ)+1V$  and the current is pulsed to minimize temperature effect.

#### ■ Dropout Voltage ( $V_{Drop}$ )

It is the difference between the input voltage and the output voltage when the circuit stops stable operation by decreasing the input voltage. It is measured when the output voltage drops 100mV from its nominal value by decreasing the input voltage gradually.

#### ■ Line Regulation (LinReg)

It is the fluctuations of the output voltage value when the input voltage is changed.

#### ■ Load Regulation (LoaReg)

It is the fluctuations of the output voltage value when the input voltage is assumed to be  $V_{out}(typ)+1V$ , and the output current is changed.

#### ■ Ripple Rejection (RR)

Ripple rejection is the ability of the regulator to attenuate the ripple content of the input voltage at the output. It is measured with the condition of  $V_{in}=V_{out}(typ)+1.5V$ . Ripple rejection is the ratio of the ripple content between the output vs. input and is expressed in dB

#### ■ Standby Current ( $I_{Standby}$ )

Standby current is the current which flows into the regulator when the output is turned off by the control function ( $V_{Cont}=0V$ ).

### Protections

#### ■ Over Current Protection

It is a function to protect the IC by limiting the output current when excessive current flows into the IC, such as the output is connected to GND, etc.

#### ■ Thermal Protection

It protects the IC not to exceed the permissible power consumption of the package in case of a large power loss inside the regulator. The output is turned off when the chip reaches around 145°C, but it turns on again when the temperature of the chip decreases.

#### ■ Reverse Voltage Protection

Reverse voltage protection prevents damage due to the output voltage being higher than the input voltage. This fault condition can occur when the output capacitor remains charged and the input is reduced to zero, or when an external voltage higher than the input voltage is applied to the output side. Generally, a LDO regulator has a diode in the input direction from an output. If an input falls from an output in an input-GND short circuit etc. and this diode turns on, current will flow for an input terminal from an output terminal. In the case of excessive current, IC may break. In order to prevent this, it is necessary to connect an Schottky Diode etc. outside. This product is equipped with reverse bias over-current prevention, and excessive current does not flow in to IC. Therefore, no need to connect diode outside.

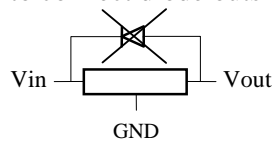

13. Recommended External Circuits

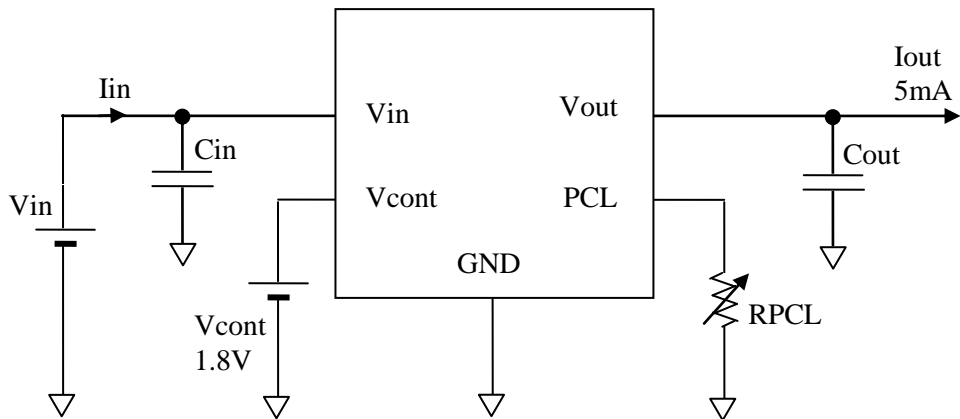
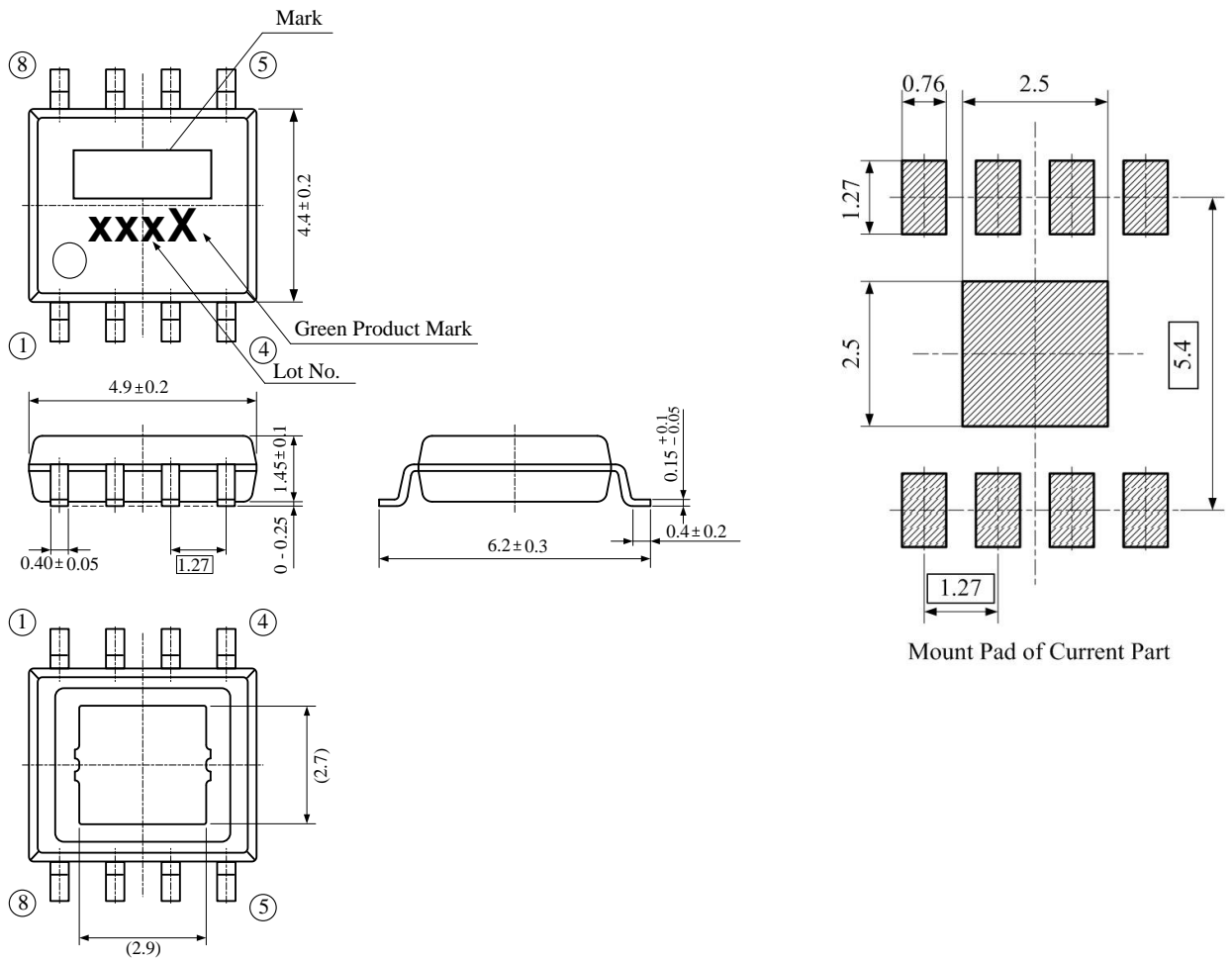

Figure 5. Recommended External Circuit (With respect to Cout and RPCL, please refer to [11.Description](#))

**14. Package**

■ **Outline Dimensions**

• Unit: mm



**15. Revise History**

Date (YY/MM/DD)	Revision	Page	Contents
14/10/29	00	-	First Edition
15/07/03	01	7	Standby Current(Istandby) max0.5 $\mu$ A→max1.5 $\mu$ A Reverse Bias Current(Irev) max0.5 $\mu$ A→max1.5 $\mu$ A

**IMPORTANT NOTICE**

0. Asahi Kasei Microdevices Corporation (“AKM”) reserves the right to make changes to the information contained in this document without notice. When you consider any use or application of AKM product stipulated in this document (“Product”), please make inquiries the sales office of AKM or authorized distributors as to current status of the Products.
1. All information included in this document are provided only to illustrate the operation and application examples of AKM Products. AKM neither makes warranties or representations with respect to the accuracy or completeness of the information contained in this document nor grants any license to any intellectual property rights or any other rights of AKM or any third party with respect to the information in this document. You are fully responsible for use of such information contained in this document in your product design or applications. **AKM ASSUMES NO LIABILITY FOR ANY LOSSES INCURRED BY YOU OR THIRD PARTIES ARISING FROM THE USE OF SUCH INFORMATION IN YOUR PRODUCT DESIGN OR APPLICATIONS.**
2. The Product is neither intended nor warranted for use in equipment or systems that require extraordinarily high levels of quality and/or reliability and/or a malfunction or failure of which may cause loss of human life, bodily injury, serious property damage or serious public impact, including but not limited to, equipment used in nuclear facilities, equipment used in the aerospace industry, medical equipment, equipment used for automobiles, trains, ships and other transportation, traffic signaling equipment, equipment used to control combustions or explosions, safety devices, elevators and escalators, devices related to electric power, and equipment used in finance-related fields. Do not use Product for the above use unless specifically agreed by AKM in writing.
3. Though AKM works continually to improve the Product’s quality and reliability, you are responsible for complying with safety standards and for providing adequate designs and safeguards for your hardware, software and systems which minimize risk and avoid situations in which a malfunction or failure of the Product could cause loss of human life, bodily injury or damage to property, including data loss or corruption.
4. Do not use or otherwise make available the Product or related technology or any information contained in this document for any military purposes, including without limitation, for the design, development, use, stockpiling or manufacturing of nuclear, chemical, or biological weapons or missile technology products (mass destruction weapons). When exporting the Products or related technology or any information contained in this document, you should comply with the applicable export control laws and regulations and follow the procedures required by such laws and regulations. The Products and related technology may not be used for or incorporated into any products or systems whose manufacture, use, or sale is prohibited under any applicable domestic or foreign laws or regulations.
5. Please contact AKM sales representative for details as to environmental matters such as the RoHS compatibility of the Product. Please use the Product in compliance with all applicable laws and regulations that regulate the inclusion or use of controlled substances, including without limitation, the EU RoHS Directive. AKM assumes no liability for damages or losses occurring as a result of noncompliance with applicable laws and regulations.
6. Resale of the Product with provisions different from the statement and/or technical features set forth in this document shall immediately void any warranty granted by AKM for the Product and shall not create or extend in any manner whatsoever, any liability of AKM.
7. This document may not be reproduced or duplicated, in any form, in whole or in part, without prior written consent of AKM.