

THIS DRAWING CONTAINS INFORMATION PROPRIETARY TO RF INDUSTRIES.
 ANY UNAUTHORIZED USE OF THIS DRAWING IS EXPRESSLY PROHIBITED
 WITHOUT WRITTEN PERMISSION FROM RF INDUSTRIES.
 ANY VIOLATION IS PUNISHABLE UNDER U.S. COPYRIGHT LAWS.

ALL DIMENSIONS ARE REFERENCE ONLY

PART NO.		RP-1212-B		
REV	DESCRIPTION	DWN	DATE	APPROVED
-	ENGINEERING RELEASE	CZS	10/27/00	JDMc
A	ADD SPECS / NEW FORMAT	GGG	11/12/01	JDMc

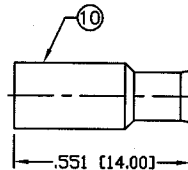
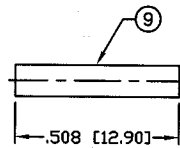
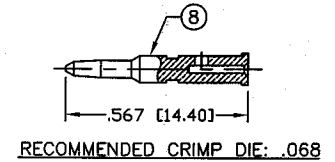
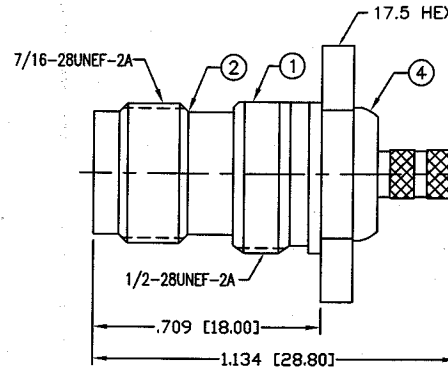
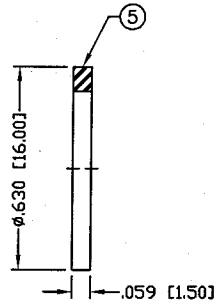
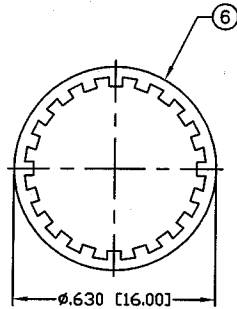
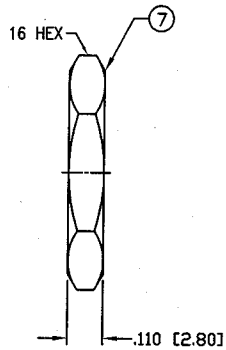

RECOMMENDED CRIMP DIE: .178

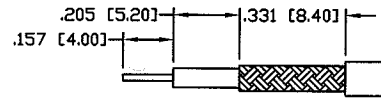

RECOMMENDED STRIPPING DIMENSIONS

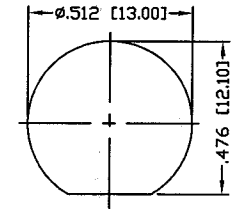

RECOMMENDED MOUNTING HOLE

MAX. PANEL THICKNESS = .138

SPECIFICATIONS:

IMPEDANCE: 50 Ohms
 FREQUENCY RANGE: 0-11 GHz
 WORKING VOLTAGE: 500 VRMS
 INSULATION RESISTANCE: 5k M ohms min.
 TEMPERATURE RANGE: -65°C TO 85°C

FOR RG-174, 188, 188A, 316/U, ALPHA 9174, 9316,
 BELDEN 8216, 83269, 83284, 84316 & TIMES LMR-100A CABLE

1	PRESS BODY	1	BRASS	NICKEL, 100μ"	008974	
2	BODY	1	BRASS	NICKEL, 100μ"		
3	INSULATOR	1	PTFE	----		
4	FERRULE STUD	1	BRASS	NICKEL, 100μ"		
5	GASKET	1	RUBBER	----		
6	LOCK WASHER	1	BRASS	NICKEL, 100μ"		
7	HEX NUT	1	BRASS	NICKEL, 100μ"		
8	PIN	1	BRASS	GOLD, 3μ"		
9	SLEEVE	1	DELFIN	----		
10	FERRULE	1	BRASS	NICKEL, 100μ"		
11					DRAWN G. GALLEGOS 11/12/01	
12					CHECKED [Signature] 11-12-01	
13					ORJ DRAWN	
14					C. ZUNIGA 10/27/20	
#	DESCRIPTION	QTY	MATRL	FINISH	APPROVALS	DATE

UNLESS OTHERWISE SPECIFIED:
 1. REMOVE ALL BURRS
 2. BREAK ALL CORNERS & EDGES .005 R. MAX.
 3. CHAMFER 1ST & LAST THREADS 45°
 4. SURFACE ROUGHNESS 63 FINISH MIL-STD-10
 5. DIAMETERS ON COMMON CENTERS TO BE CONCENTRIC WITHIN .002 T.I.R.
 6. ALL DIMENSIONS ARE AFTER PLATING.

DIMENSIONS ARE IN INCHES AND [MILLIMETERS]
 UNLESS OTHERWISE NOTED TOLERANCES ARE:
 DECIMALS .XXX±.003 [.08]
 DIAMETER .XX±.001 [.03]
 .XX±.005 [.13]

RF connectors
 DIVISION OF RF INDUSTRIES, LTD.
 7610 MIRAMAR RD
 SAN DIEGO, CA 92126
 (858) 549-6340
 (858) 549-6345 FAX

TNC JACK, REVERSE POLARITY

BULKHEAD, CRIMP

SIZE	CABLE GROUP	DWG NO.	REV
A	B	RP-1212-B	A
SCALE: NTS		CAD FILE OUTLINE	SHEET 1 OF 1