

END OF LIFE

PD - 96115B

International  
**IR** Rectifier

**IRF9952QPbF**

HEXFET® Power MOSFET

- Advanced Process Technology
- Ultra Low On-Resistance
- Dual N and P Channel MOSFET
- Surface Mount
- Available in Tape & Reel
- 150°C Operating Temperature
- Lead-Free

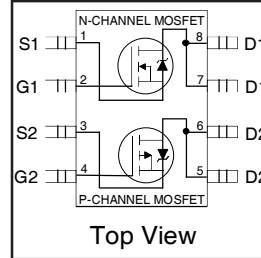

	N-Ch	P-Ch
$V_{DS}$	30V	-30V
$R_{DS(on)}$	0.10Ω	0.25Ω

**Description**

These HEXFET® Power MOSFET's in a Dual SO-8 package utilize the latest processing techniques to achieve extremely low on-resistance per silicon area. Additional features of these HEXFET Power MOSFET's are a 150°C junction operating temperature, fast switching speed and improved repetitive avalanche rating. These benefits combine to make this design an extremely efficient and reliable device for use in a wide variety of applications. The efficient SO-8 package provides enhanced thermal characteristics and dual MOSFET die capability making it ideal in a variety of power applications. This dual, surface mount SO-8 can dramatically reduce board space and is also available in Tape & Reel.

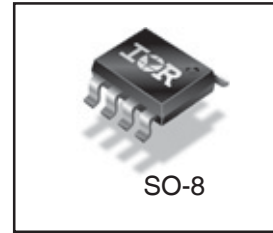

Base part number	Orderable part number	Package Type	Standard Pack		EOL Notice	Replacement Part Number
			Form	Quantity		
IRF9952QPbF	IRF9952QTRPbF	SO-8	Tape and Reel	4000	EOL 529	<a href="#">Please search the EOL part number on IR's website for guidance</a>
	IRF9952QPbF	SO-8	Tube	95	EOL 529	

	Symbol	Maximum		Units	
		N-Channel	P-Channel		
Drain-Source Voltage	$V_{DS}$	30		V	
Gate-Source Voltage	$V_{GS}$	± 20			
Continuous Drain Current <sup>⑤</sup>	$I_D$	$T_A = 25^\circ\text{C}$	3.5	-2.3	A
		$T_A = 70^\circ\text{C}$	2.8	-1.8	
Pulsed Drain Current	$I_{DM}$	16	-10		
Continuous Source Current (Diode Conduction)	$I_S$	1.7	-1.3		
Maximum Power Dissipation <sup>⑤</sup>	$P_D$	$T_A = 25^\circ\text{C}$	2.0		W
		$T_A = 70^\circ\text{C}$	1.3		
Single Pulse Avalanche Energy	$E_{AS}$	44	57	mJ	
Avalanche Current	$I_{AR}$	2.0	-1.3	A	
Repetitive Avalanche Energy	$E_{AR}$	0.25		mJ	
Peak Diode Recovery dv/dt <sup>②</sup>	dv/dt	5.0	-5.0	V/ ns	
Junction and Storage Temperature Range	$T_J, T_{STG}$	-55 to + 150		°C	

**Thermal Resistance Ratings**

Parameter	Symbol	Limit	Units
Maximum Junction-to-Ambient <sup>⑤</sup>	$R_{\theta JA}$	62.5	°C/W

**END OF LIFE**

# IRF9952QPbF

International  
**IR** Rectifier

## Electrical Characteristics @ T<sub>J</sub> = 25°C (unless otherwise specified)

Parameter	Description		Min.	Typ.	Max.	Units	Conditions
V <sub>(BR)DSS</sub>	Drain-to-Source Breakdown Voltage	N-Ch	30	—	—	V	V <sub>GS</sub> = 0V, I <sub>D</sub> = 250μA
		P-Ch	-30	—	—		V <sub>GS</sub> = 0V, I <sub>D</sub> = -250μA
ΔV <sub>(BR)DSS</sub> /ΔT <sub>J</sub>	Breakdown Voltage Temp. Coefficient	N-Ch	—	0.015	—	V/°C	Reference to 25°C, I <sub>D</sub> = 1mA
		P-Ch	—	0.015	—		Reference to 25°C, I <sub>D</sub> = -1mA
R <sub>DS(ON)</sub>	Static Drain-to-Source On-Resistance	N-Ch	—	0.08	0.10	Ω	V <sub>GS</sub> = 10V, I <sub>D</sub> = 2.2A ④
			—	0.12	0.15		V <sub>GS</sub> = 4.5V, I <sub>D</sub> = 1.0A ④
		P-Ch	—	0.165	0.250		V <sub>GS</sub> = -10V, I <sub>D</sub> = -1.0A ④
			—	0.290	0.400		V <sub>GS</sub> = -4.5V, I <sub>D</sub> = -0.50A ④
V <sub>GS(th)</sub>	Gate Threshold Voltage	N-Ch	1.0	—	—	V	V <sub>DS</sub> = V <sub>GS</sub> , I <sub>D</sub> = 250μA
		P-Ch	-1.0	—	—		V <sub>DS</sub> = V <sub>GS</sub> , I <sub>D</sub> = -250μA
g <sub>fs</sub>	Forward Transconductance	N-Ch	—	12	—	S	V <sub>DS</sub> = 15V, I <sub>D</sub> = 3.5A ④
		P-Ch	—	2.4	—		V <sub>DS</sub> = -15V, I <sub>D</sub> = -2.3A ④
I <sub>DSS</sub>	Drain-to-Source Leakage Current	N-Ch	—	—	2.0	μA	V <sub>DS</sub> = 24V, V <sub>GS</sub> = 0V
		P-Ch	—	—	-2.0		V <sub>DS</sub> = -24V, V <sub>GS</sub> = 0V
		N-Ch	—	—	25		V <sub>DS</sub> = 24V, V <sub>GS</sub> = 0V, T <sub>J</sub> = 125°C
		P-Ch	—	—	-25		V <sub>DS</sub> = -24V, V <sub>GS</sub> = 0V, T <sub>J</sub> = 125°C
I <sub>GSS</sub>	Gate-to-Source Forward Leakage	N-P	—	—	±100	nA	V <sub>GS</sub> = ±20V
Q <sub>g</sub>	Total Gate Charge	N-Ch	—	6.9	14	nC	N-Channel I <sub>D</sub> = 1.8A, V <sub>DS</sub> = 10V, V <sub>GS</sub> = 10V ④
		P-Ch	—	6.1	12		
Q <sub>gs</sub>	Gate-to-Source Charge	N-Ch	—	1.0	2.0	nC	P-Channel I <sub>D</sub> = -2.3A, V <sub>DS</sub> = -10V, V <sub>GS</sub> = -10V ④
		P-Ch	—	1.7	3.4		
Q <sub>gd</sub>	Gate-to-Drain ("Miller") Charge	N-Ch	—	1.8	3.5	nC	P-Channel I <sub>D</sub> = -2.3A, V <sub>DS</sub> = -10V, V <sub>GS</sub> = -10V ④
		P-Ch	—	1.1	2.2		
t <sub>d(on)</sub>	Turn-On Delay Time	N-Ch	—	6.2	12	ns	N-Channel V <sub>DD</sub> = 10V, I <sub>D</sub> = 1.0A, R <sub>G</sub> = 6.0Ω, R <sub>D</sub> = 10Ω ④
		P-Ch	—	9.7	19		
t <sub>r</sub>	Rise Time	N-Ch	—	8.8	18	ns	P-Channel V <sub>DD</sub> = -10V, I <sub>D</sub> = -1.0A, R <sub>G</sub> = 6.0Ω, R <sub>D</sub> = 10Ω ④
		P-Ch	—	14	28		
t <sub>d(off)</sub>	Turn-Off Delay Time	N-Ch	—	13	26	ns	P-Channel V <sub>DD</sub> = -10V, I <sub>D</sub> = -1.0A, R <sub>G</sub> = 6.0Ω, R <sub>D</sub> = 10Ω ④
		P-Ch	—	20	40		
t <sub>f</sub>	Fall Time	N-Ch	—	3.0	6.0	ns	P-Channel V <sub>DD</sub> = -10V, I <sub>D</sub> = -1.0A, R <sub>G</sub> = 6.0Ω, R <sub>D</sub> = 10Ω ④
		P-Ch	—	6.9	14		
C <sub>iss</sub>	Input Capacitance	N-Ch	—	190	—	pF	N-Channel V <sub>GS</sub> = 0V, V <sub>DS</sub> = 15V, f = 1.0MHz
		P-Ch	—	190	—		
C <sub>oss</sub>	Output Capacitance	N-Ch	—	120	—	pF	P-Channel V <sub>GS</sub> = 0V, V <sub>DS</sub> = -15V, f = 1.0MHz
		P-Ch	—	110	—		
C <sub>rss</sub>	Reverse Transfer Capacitance	N-Ch	—	61	—	pF	P-Channel V <sub>GS</sub> = 0V, V <sub>DS</sub> = -15V, f = 1.0MHz
		P-Ch	—	54	—		

## Source-Drain Ratings and Characteristics

Parameter	Description		Min.	Typ.	Max.	Units	Conditions
I <sub>S</sub>	Continuous Source Current (Body Diode)	N-Ch	—	—	1.7	A	
		P-Ch	—	—	-1.3		
I <sub>SM</sub>	Pulsed Source Current (Body Diode) ①	N-Ch	—	—	16	A	
		P-Ch	—	—	16		
V <sub>SD</sub>	Diode Forward Voltage	N-Ch	—	0.82	1.2	V	T <sub>J</sub> = 25°C, I <sub>S</sub> = 1.25A, V <sub>GS</sub> = 0V ③
		P-Ch	—	-0.82	-1.2		T <sub>J</sub> = 25°C, I <sub>S</sub> = -1.25A, V <sub>GS</sub> = 0V ③
t <sub>rr</sub>	Reverse Recovery Time	N-Ch	—	27	53	ns	N-Channel T <sub>J</sub> = 25°C, I <sub>F</sub> = 1.25A, di/dt = 100A/μs
		P-Ch	—	27	54		
Q <sub>rr</sub>	Reverse Recovery Charge	N-Ch	—	28	57	nC	P-Channel T <sub>J</sub> = 25°C, I <sub>F</sub> = -1.25A, di/dt = 100A/μs ④
		P-Ch	—	31	62		

**Notes:**

- ① Repetitive rating; pulse width limited by max. junction temperature. ( See fig. 23 )
- ② N-Channel I<sub>SD</sub> ≤ 2.0A, di/dt ≤ 100A/μs, V<sub>DD</sub> ≤ V<sub>(BR)DSS</sub>, T<sub>J</sub> ≤ 150°C
- ③ N-Channel Starting T<sub>J</sub> = 25°C, L = 22mH R<sub>G</sub> = 25Ω, I<sub>AS</sub> = 2.0A. (See Figure 12)
- ④ Pulse width ≤ 300μs; duty cycle ≤ 2%.
- ⑤ Surface mounted on FR-4 board, t ≤ 10sec.
- P-Channel I<sub>SD</sub> ≤ -1.3A, di/dt ≤ 84A/μs, V<sub>DD</sub> ≤ V<sub>(BR)DSS</sub>, T<sub>J</sub> ≤ 150°C
- P-Channel Starting T<sub>J</sub> = 25°C, L = 67mH R<sub>G</sub> = 25Ω, I<sub>AS</sub> = -1.3A.

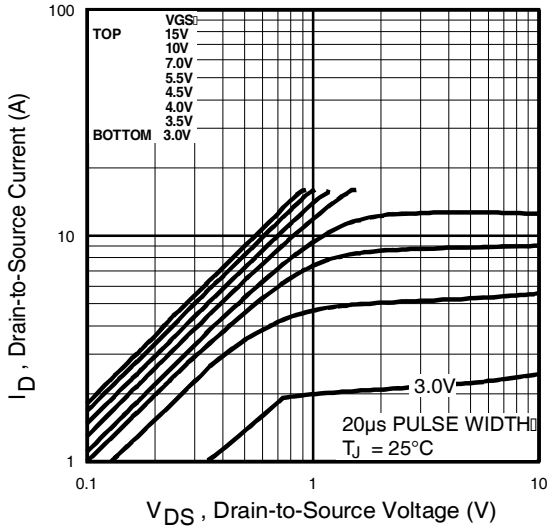

**Fig 1.** Typical Output Characteristics

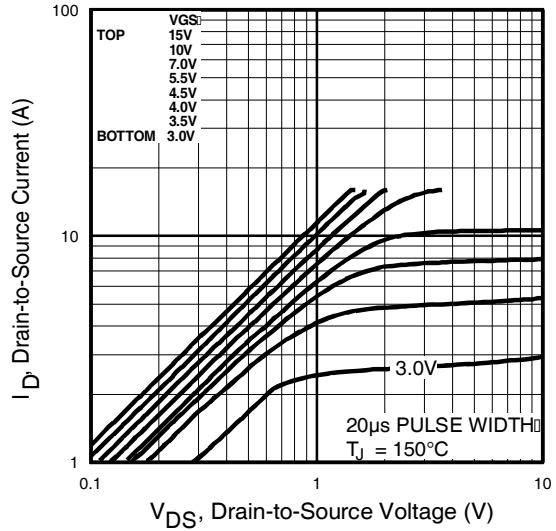

**Fig 2.** Typical Output Characteristics

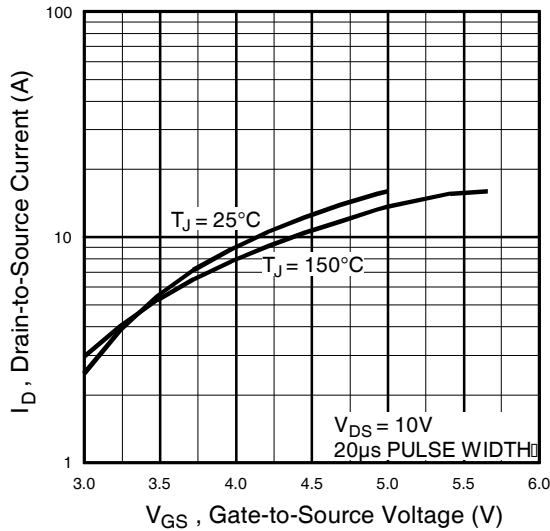

**Fig 3.** Typical Transfer Characteristics

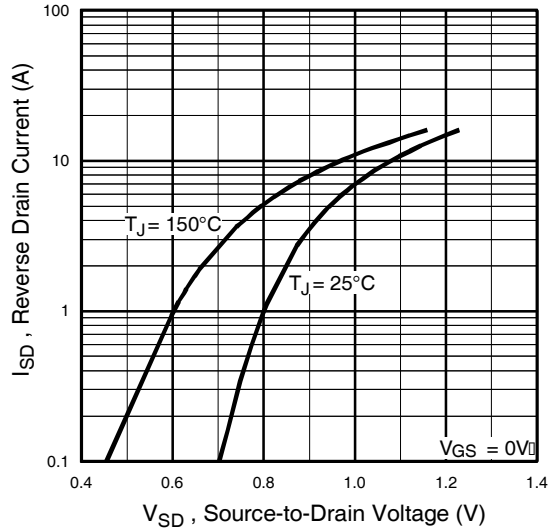

**Fig 4.** Typical Source-Drain Diode Forward Voltage

END OF LIFE

# IRF9952QPbF

N-Channel

International  
**IR** Rectifier

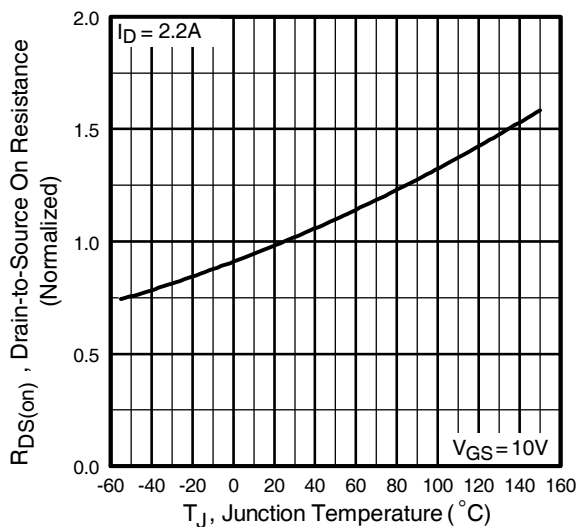

Fig 5. Normalized On-Resistance Vs. Temperature

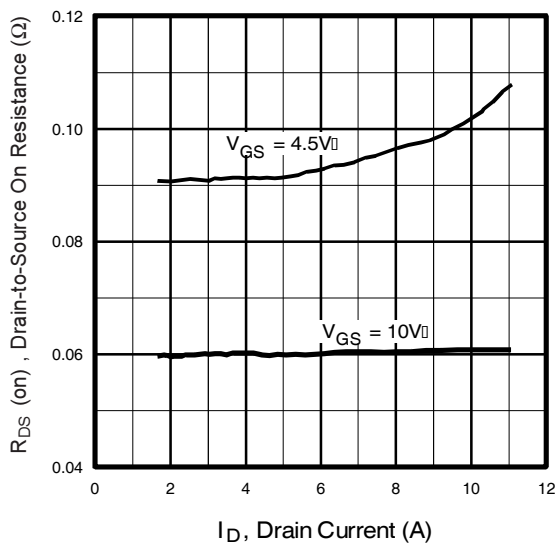

Fig 6. Typical On-Resistance Vs. Drain Current

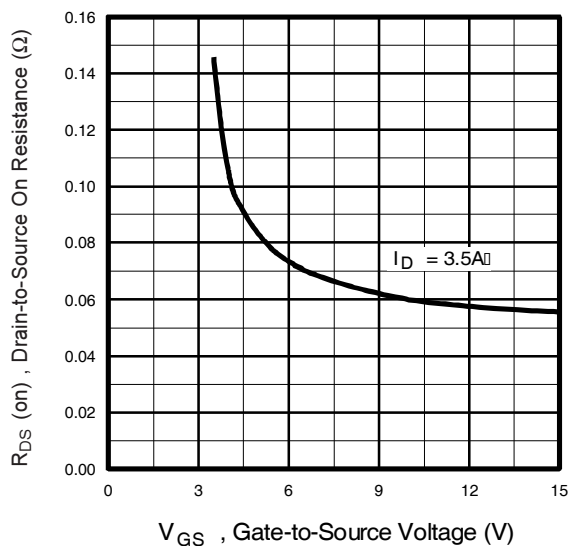

Fig 7. Typical On-Resistance Vs. Gate Voltage

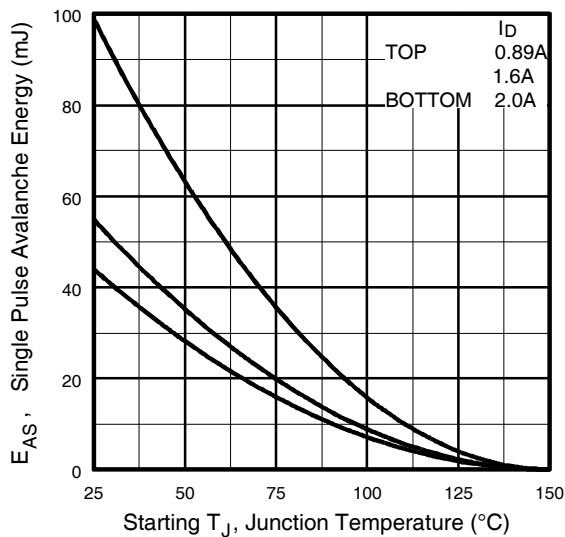

Fig 8. Maximum Avalanche Energy Vs. Drain Current

**END OF LIFE**

International  
**IR** Rectifier

N-Channel

**IRF9952QPbF**

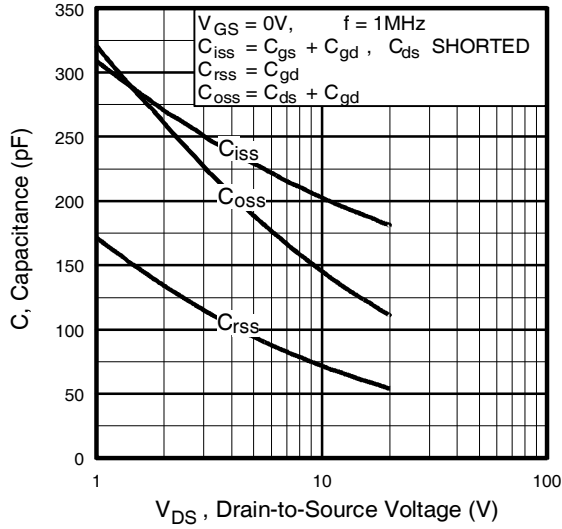

**Fig 9.** Typical Capacitance Vs. Drain-to-Source Voltage

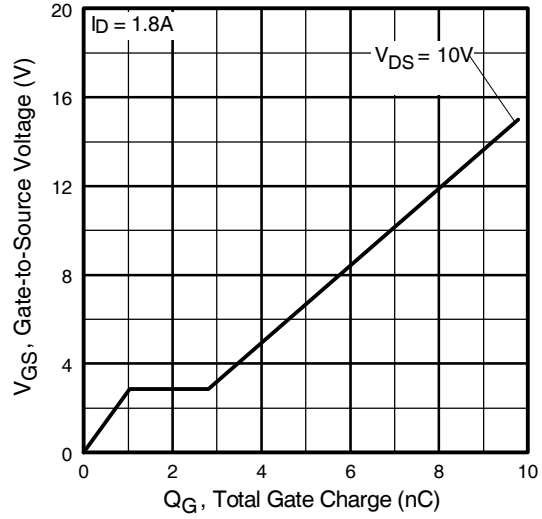

**Fig 10.** Typical Gate Charge Vs. Gate-to-Source Voltage

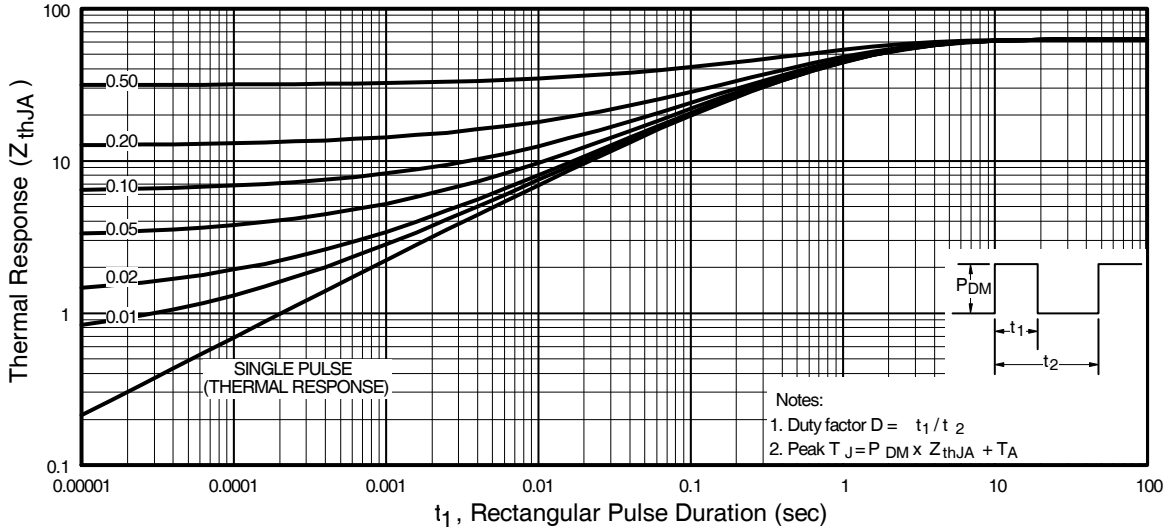

**Fig 11.** Maximum Effective Transient Thermal Impedance, Junction-to-Ambient

END OF LIFE

# IRF9952QPbF

P-Channel

International  
**IR** Rectifier

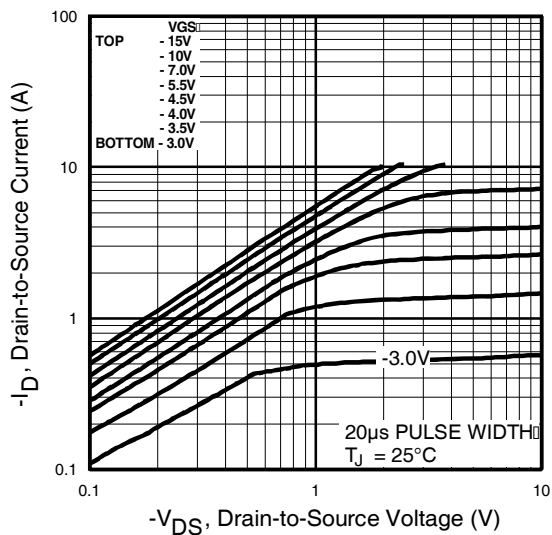

Fig 12. Typical Output Characteristics

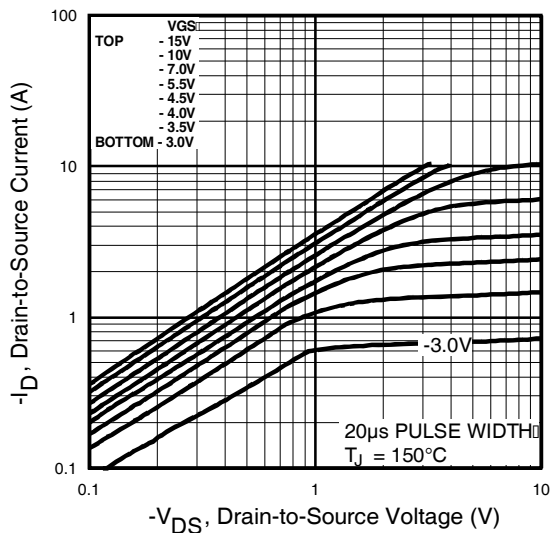

Fig 13. Typical Output Characteristics

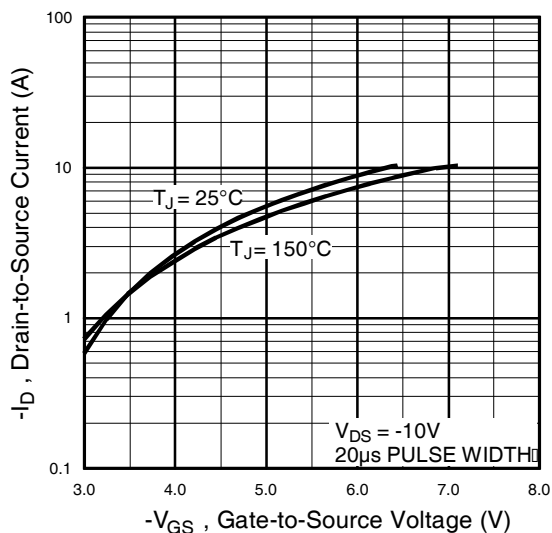

Fig 14. Typical Transfer Characteristics

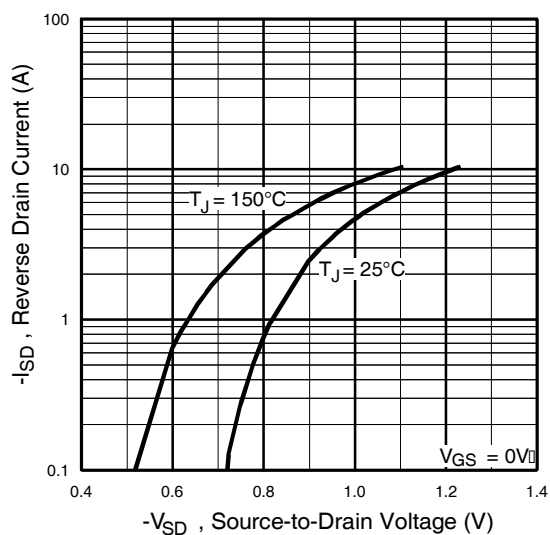
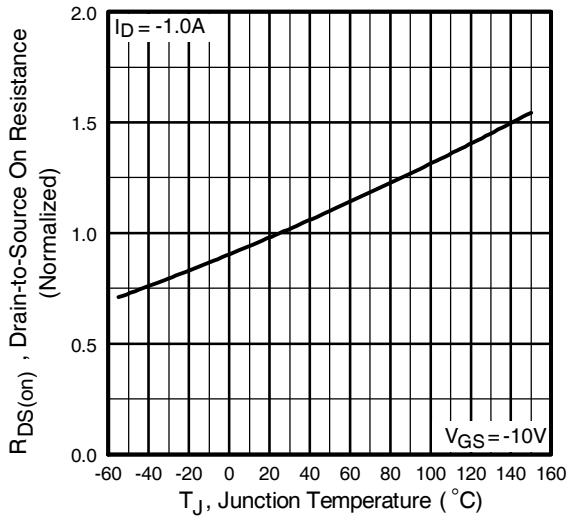
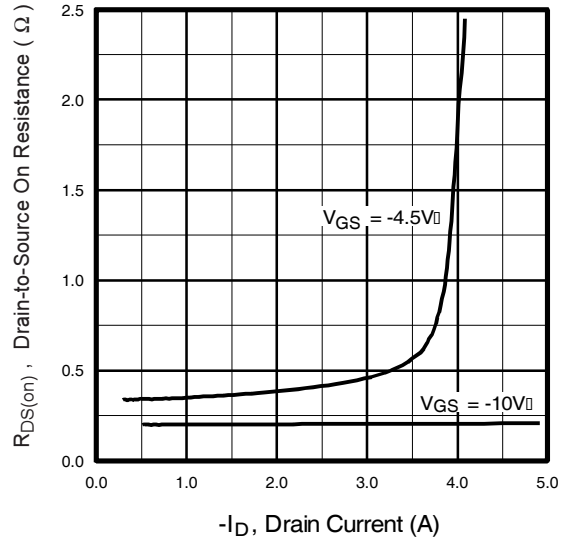

Fig 15. Typical Source-Drain Diode Forward Voltage



**Fig 16.** Normalized On-Resistance Vs. Temperature



**Fig 17.** Typical On-Resistance Vs. Drain Current

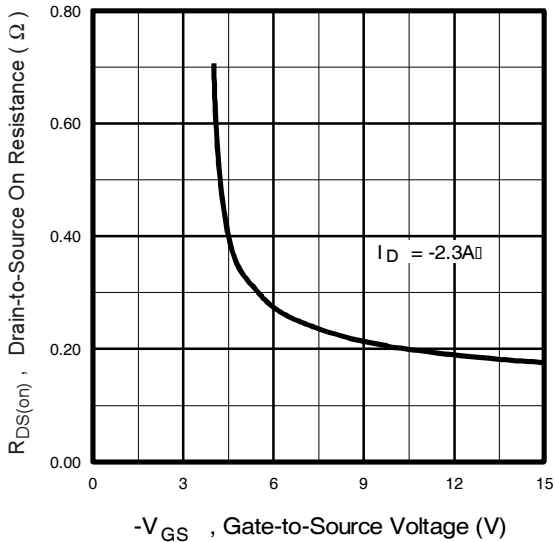

**Fig 18.** Typical On-Resistance Vs. Gate Voltage

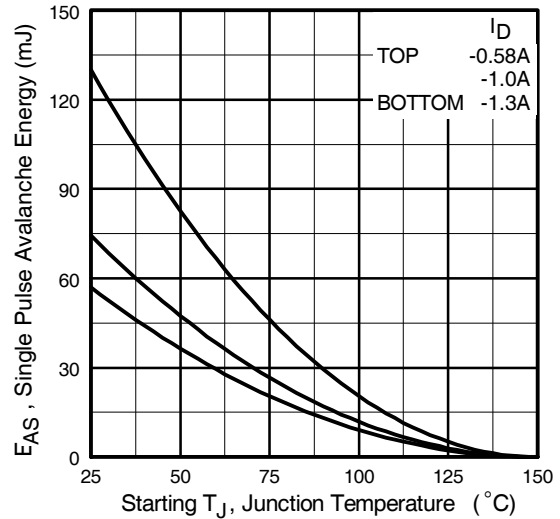

**Fig 19.** Maximum Avalanche Energy Vs. Drain Current

**END OF LIFE**

# IRF9952QPbF

P-Channel

International  
**IR** Rectifier

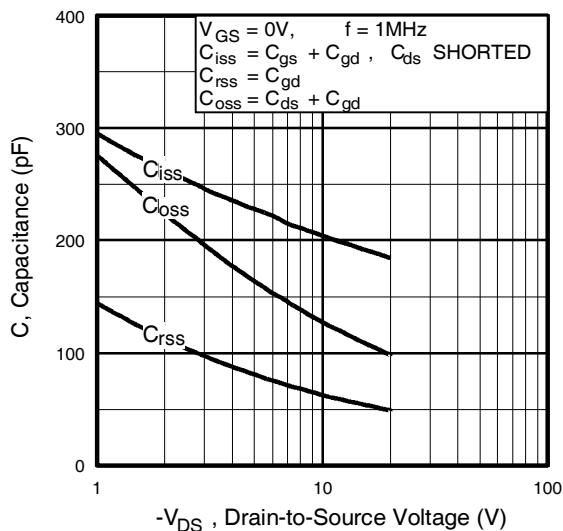

**Fig 20.** Typical Capacitance Vs. Drain-to-Source Voltage

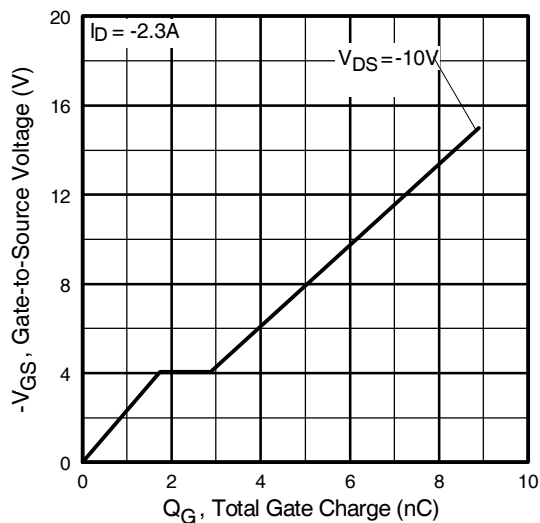

**Fig 21.** Typical Gate Charge Vs. Gate-to-Source Voltage

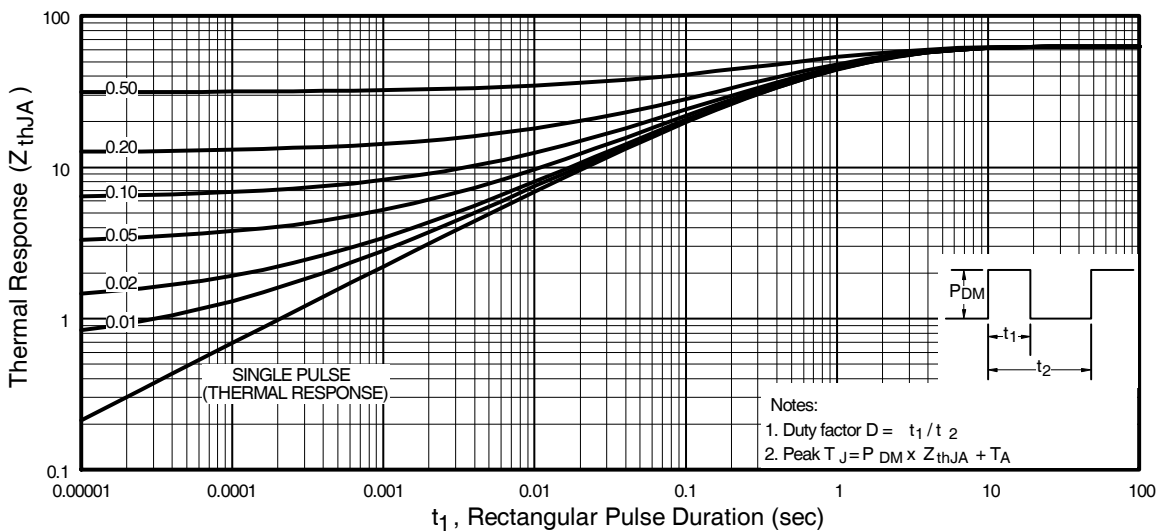

**Fig 22.** Maximum Effective Transient Thermal Impedance, Junction-to-Ambient



**END OF LIFE**

International  
**IR** Rectifier

# IRF9952QPbF

## SO-8 Package Outline

Dimensions are shown in millimeters (inches)

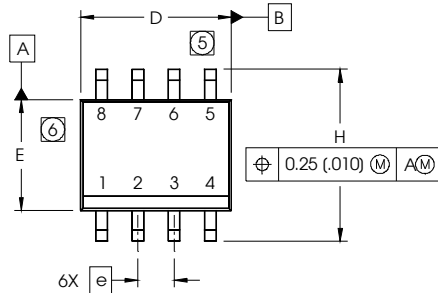

DIM	INCHES		MILLIMETERS	
	MIN	MAX	MIN	MAX
A	.0532	.0688	1.35	1.75
A1	.0040	.0098	0.10	0.25
b	.013	.020	0.33	0.51
c	.0075	.0098	0.19	0.25
D	.189	.1968	4.80	5.00
E	.1497	.1574	3.80	4.00
e	.050 BASIC		1.27 BASIC	
e1	.025 BASIC		0.635 BASIC	
H	.2284	.2440	5.80	6.20
K	.0099	.0196	0.25	0.50
L	.016	.050	0.40	1.27
y	0°	8°	0°	8°

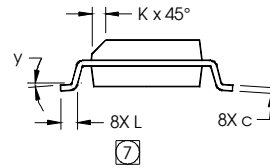
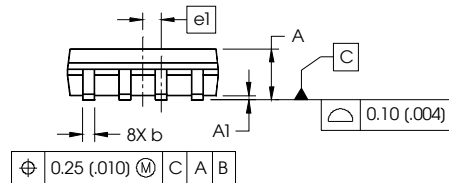

**NOTES:**

1. DIMENSIONING & TOLERANCING PER ASME Y14.5M-1994.
2. CONTROLLING DIMENSION: MILLIMETER
3. DIMENSIONS ARE SHOWN IN MILLIMETERS (INCHES).
4. OUTLINE CONFORMS TO JEDEC OUTLINE MS-012AA.
- ⑤ DIMENSION DOES NOT INCLUDE MOLD PROTRUSIONS. MOLD PROTRUSIONS NOT TO EXCEED 0.15 (.006).
- ⑥ DIMENSION DOES NOT INCLUDE MOLD PROTRUSIONS. MOLD PROTRUSIONS NOT TO EXCEED 0.25 (.010).
- ⑦ DIMENSION IS THE LENGTH OF LEAD FOR SOLDERING TO A SUBSTRATE.

**FOOTPRINT**

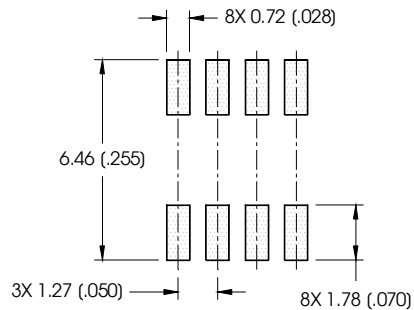

## SO-8 Part Marking

EXAMPLE: THIS IS AN IRF7101 (MOSFET)

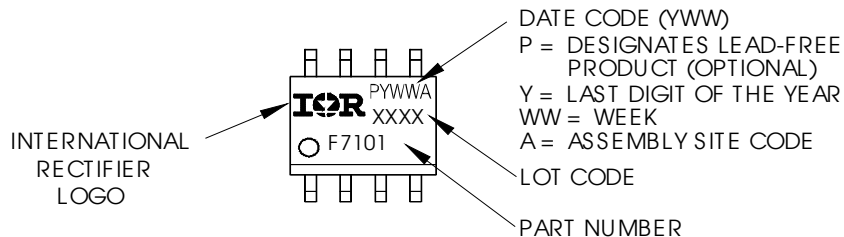

**Notes:**

1. For an Automotive Qualified version of this part please see: <http://www.irf.com/product-info/autos>
2. For the most current drawing please refer to IR website at <http://www.irf.com/package/>

**END OF LIFE**

# IRF9952QPbF

International  
**IR** Rectifier

## SO-8 Tape and Reel

Dimensions are shown in millimeters (inches)

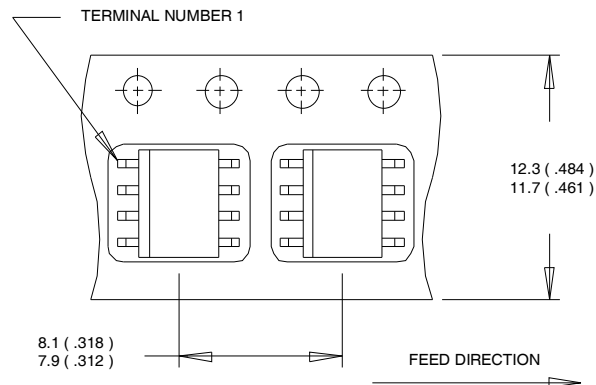

**NOTES:**

1. CONTROLLING DIMENSION : MILLIMETER.
2. ALL DIMENSIONS ARE SHOWN IN MILLIMETERS(INCHES).
3. OUTLINE CONFORMS TO EIA-481 & EIA-541.

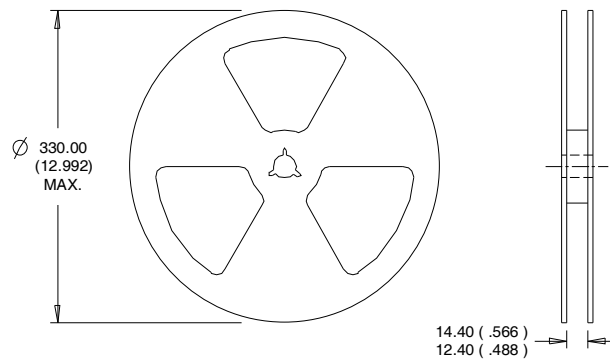

**NOTES :**

1. CONTROLLING DIMENSION : MILLIMETER.
2. OUTLINE CONFORMS TO EIA-481 & EIA-541.

For the most current drawing please refer to IR website at <http://www.irf.com/package/>

**END OF LIFE**

**Qualification Information<sup>†</sup>**

Qualification level	Industrial <sup>†</sup>	
	(per JEDEC JESD47F <sup>††</sup> guidelines)	
Moisture Sensitivity Level	SO-8	MSL1 (per JEDEC J-STD-020D <sup>††</sup> )
RoHS Compliant	Yes	

† Qualification standards can be found at International Rectifier's web site  
<http://www.irf.com/product-info/reliability>

†† Applicable version of JEDEC standard at the time of product release.

**Revision History**

Date	Comments
10/3/2014	• Added ordering information to reflect the End-Of-life