

GPS & GLONASS External Active Antennas

Product Number : ATGG46015-BP

1. Picture



2. Electrical Characteristics

Antenna		
1	Antenna model	2520A (25mm*25mm*2mm)
2	Frequency Range	GPS : 1575.42MHz±1.023MHz
		GLONAS : 1609.3 MHz±5MHz
3	V.S.W.R	2.0 MAX
4	Band With@10dB	GPS : 5MHz MIN
		GLONAS : 10MHz MIN
5	Gain	GPS : 3.0 dB typ @70mm*70mm groundplane
		GLONASS : 4.0 dB typ @70mm*70mm groundplane
6	Impedence	50Ω
7	Polarization	RHCP
LNA		
1	Frequency Range	GPS : 1575.42MHz±1.023MHz
		GLONASS : 1609.3 MHz±5MHz
2	DC Voltage	3.3±0.3V
3	DC current	12±2mA(@3.0V)
4	Gain	GPS :26±3dB(without cable @25°C±10°C)
		GLONASS :26±3dB(without cable @25°C±10°C)
5	Output VSWR	2.0 MAX
6	Noise Figure	2.2 MAX

3. Environment Condition

1	Working Temp	-40°C ~ +85°C , 10%~95% RH
2	Storage Temp	-55°C ~ +100°C , 10%~95% RH
3	Vibration	Sine sweep @ 1.5mmAM 10~55Hz each Axis
4	Waterproof	IP66

4. Testing Curve

4.1 Patch Simth & VSWR

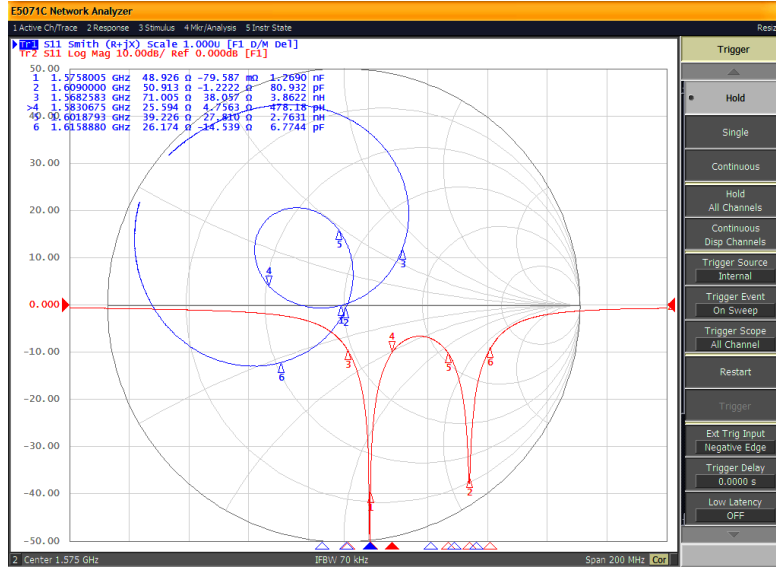

4.2 Noise Figure

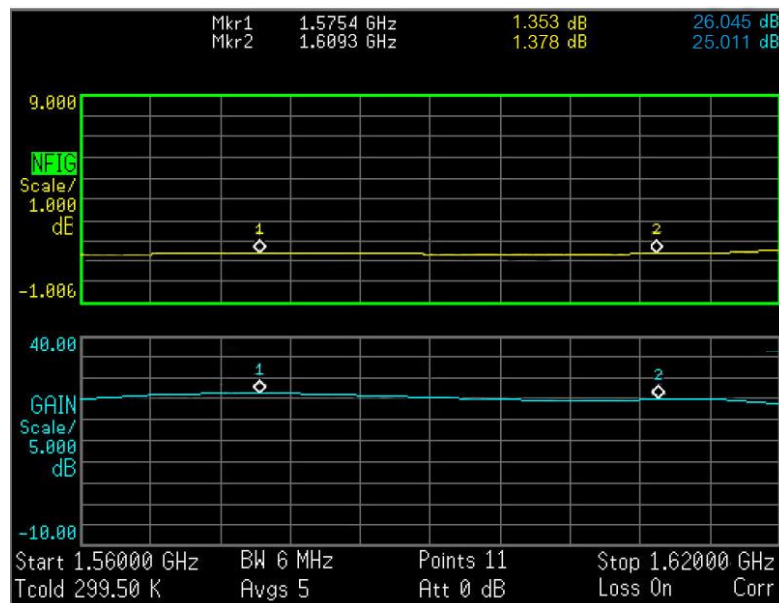

4.3 Patch Directional diagram

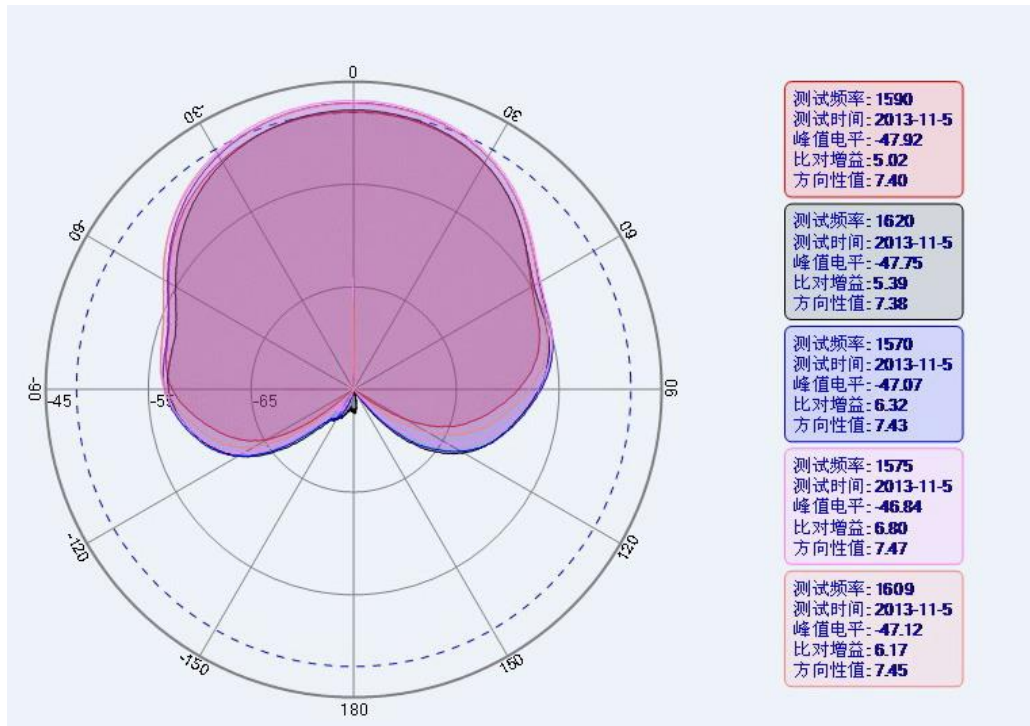

4.4 LNA Gain

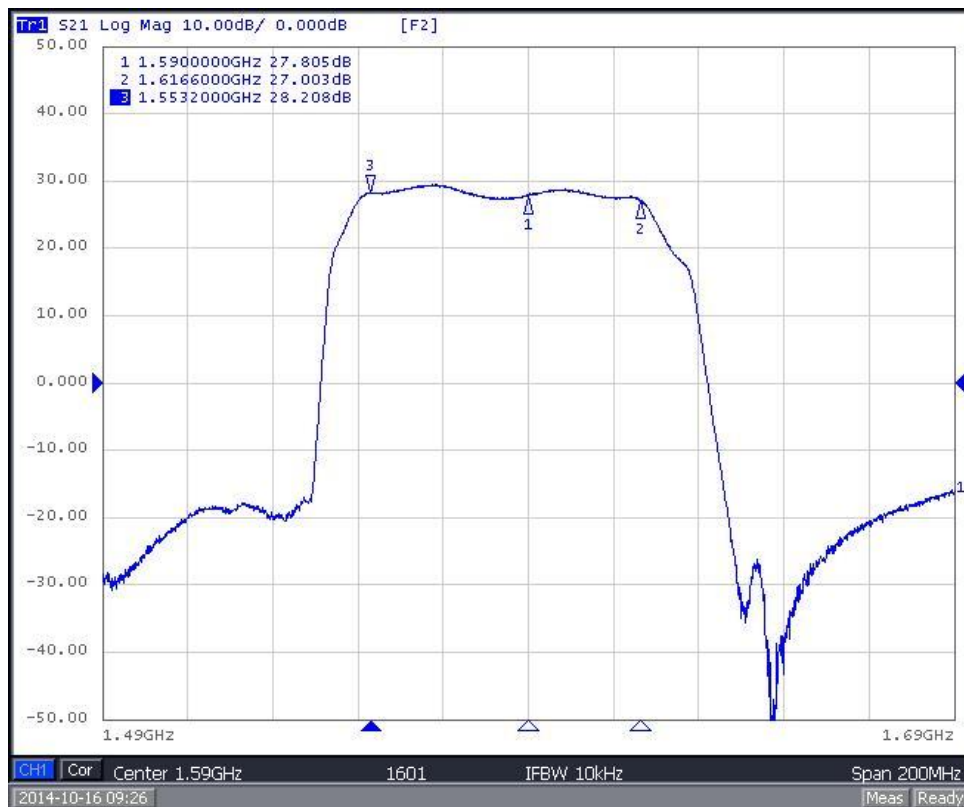

5. Drawing

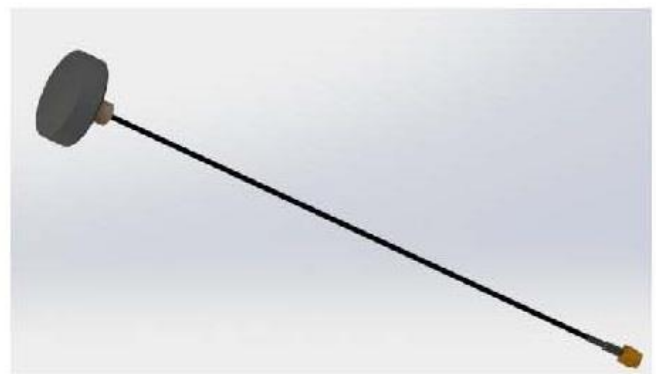
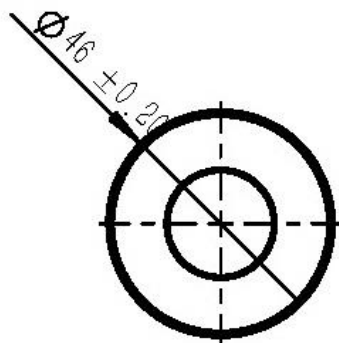
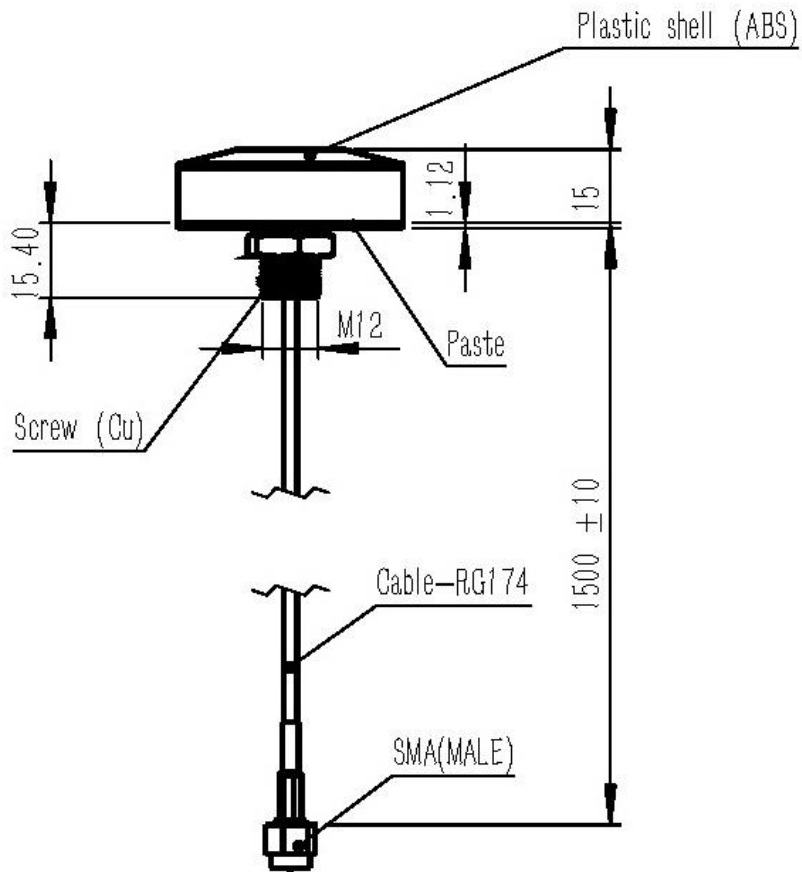

Unit:mm

6. Characteristics and Reliability Test

Test Items		Test Condition and Procedure	Requirements
C1	S.W.R.	Set DUT on Network Analyzer; make individual calibration to test	Directive DUT specification
C2	Antenna Gain	Set DUT on Antenna Chamber; make individual calibration to test	Directive DUT specification
M1	Vibration	MIL-STD-202G, 201A Amplitude: 0.03 inch (0.76mm); Freq: 10 to 55 Hz 3 directions; 2 hours for each direction	1. No Visual Damage 2. Frequency Tol.<= 5%
M2	Random Drop	Height: 1.5 Meter; 3 directions; 1 time for each direction	1. No parts separated 2. Frequency Tol.<= 5%
M3	Solderability	MIL-STD-202G, 210F, cond. A Solder iron: 350±10°C; Duration: 5 seconds	1. Mounted on PCB 2. No Visual Damage
M4	Terminal-Pull Test	MIL-STD-202G, 211A, cond. A Holding with individual specification; force applied to axis of terminal	1. Directive DUT specification 2. Frequency Tol.<= 5%
M5	Terminal-Torque Test	MIL-STD-202G, 211A, cond. E Holding with individual specification; applied clockwise and counterclockwise to the axis of terminal	1. Directive DUT specification 2. Frequency Tol.<= 5%
M6	Dimension	Inspection of dimension, color, material, package, surface process	Directive DUT specification
E1	Salt Spray	MIL-STD-202G, 101E, cond. B Temp: 35°C; RH: >= 95%; NaCl solution: >= 5%; Time: 48 hours	After 2 Hours Recovery 1. No Visual Damage 2. Frequency Tol.<= 5%
E2	Humidity	MIL-STD-202G, 103B, cond. B Temp: 40°C; RH: >= 95%; Time: 48 hours	After 2 Hours Recovery 1. No Visual Damage 2. Frequency Tol.<= 5%
E3	Thermal Shock	1 Cycle: - 40°C (30 minutes) to + 80°C (30 minutes) Cycles: 24	After 2 Hours Recovery 1. No Visual Damage 2. Frequency Tol.<= 5%
E4	Life (High Temp.)	MIL-STD-202G, 108A, cond. A Temp: 85°C; Time: 96 hours	After 2 Hours Recovery 1. No Visual Damage 2. Frequency Tol.<= 5%
R1	RoHS	With Reference to IEC 62321:2008 with flow chart	Directive RoHS 2002/95/EC
R2	PFOS	With Reference to USA EPA 3540C:1996 by LC/MS	Directive RoHS 2006/122/EC
R3	PFOA	With Reference to USA EPA 3540C:1996 by LC/MS	Directive RoHS 2006/122/EC

7. Note

7.1 This product specification guarantees the quality of our product as a single unit. Please make sure that your product is evaluated and confirmed against your specifications when our product is mounted to your product.

7.2 The product will get free warranty for one year since the date of purchase users operate in the correct way; users will have to pay cost of the materials and maintaining fee out of the condition.

7.3 Electrostatic sensitive device.Observe precautions for handling.