

Automotive-grade, very high accuracy (25  $\mu$ V), high bandwidth (3 MHz), high temperature (150  $^{\circ}$ C), zero-drift operational amplifiers

## Features

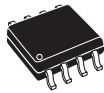

SOT23-5



SO8

- AEC-Q100 qualified 
- Very high accuracy and stability:
  - 25  $\mu$ V max. offset voltage at 25  $^{\circ}$ C
  - 44  $\mu$ V offset voltage over full temperature range
- Rail-to-rail input and output
- Low supply voltage: 2.2 - 5.5 V
- Low power consumption: 1 mA max. at 5 V
- Gain bandwidth product: 3 MHz
- Extended temperature range: -40 to 150  $^{\circ}$ C
- Micropackage: SOT23-5, SO8
- Benefits:
  - Higher accuracy without calibration
  - Accuracy virtually unaffected by temperature change

## Applications

- High accuracy signal conditioning
- Current measurement
- Sensor signal conditioning
- Automotive

## Description

The **TSZ181H** and **TSZ182H** are a single and dual operational amplifier, featuring very low offset voltages with virtually zero-drift versus temperature changes. The **TSZ181H** and **TSZ182H** offer rail-to-rail input and output, excellent speed/power consumption ratio, and 3 MHz gain bandwidth product, while consuming just 1 mA at 5 V. The device operates over an extended range of -40 to +150 $^{\circ}$ C and features an ultra-low input bias current. These features make the **TSZ181H** and **TSZ182H** ideal for high-accuracy high-bandwidth sensor interfaces for automotive environment.

### Maturity status link

TSZ181H, TSZ182H

### Related products

TSZ181, TSZ182

For - 40/125  $^{\circ}$ C range

# 1 Package pin connections

Figure 1. Pin connections (top view)

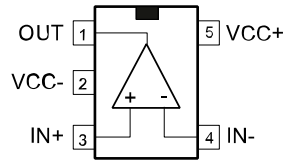

SOT23-5 (TSZ181H)

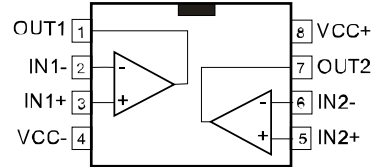

SO8 (TSZ182H)

## 2 Absolute maximum ratings and operation conditions

**Table 1. Absolute maximum ratings**

Symbol	Parameter	Value	Unit	
$V_{CC}$	Supply voltage <sup>(1)</sup>	6	V	
$V_{id}$	Differential input voltage <sup>(2)</sup>	$\pm V_{CC}$	V	
$V_{in}$	Input voltage <sup>(3)</sup>	$(V_{CC-})-0.2$ to $(V_{CC+})+0.2$	V	
$I_{in}$	Input current <sup>(4)</sup>	10	mA	
$T_{stg}$	Storage temperature	-65 to 150	°C	
$T_j$	Junction temperature	160	°C	
$R_{th-ja}$	Thermal resistance junction to ambient <sup>(5)(6)</sup>	SO8	125	°C/W
		SOT23-5	250	
ESD	Human body model (HBM) <sup>(7)</sup>	4	kV	
	Charged device model (CDM) <sup>(8)</sup>	1.5		

1. All voltage values, except differential voltage, are with respect to network ground terminal.
2. The differential voltage is the non-inverting input terminal with respect to the inverting input terminal.
3.  $V_{CC} - V_{in}$  must not exceed 6 V,  $V_{in}$  must not exceed 6 V.
4. Input current must be limited by a resistor in series with the inputs.
5.  $R_{th}$  are typical values.
6. Short-circuits can cause excessive heating and destructive dissipation.
7. Human body model: 100 pF discharged through a 1.5 kΩ resistor between two pins of the device, done for all couples of pin combinations with other pins floating.
8. Charged device model: all pins plus packages are charged together to the specified voltage and then discharged directly to ground.

**Table 2. Operating conditions**

Symbol	Parameter	Value	Unit
$V_{CC}$	Supply voltage	2.2 to 5.5	V
$V_{icm}$	Common mode voltage on input pins	$(V_{CC-})-0.1$ to $(V_{CC+})+0.1$	V
T	Operating free-air temperature range	-40 to 150	°C

### 3 Electrical characteristics

**Table 3. Electrical characteristics ( $V_{CC+} = 2.2\text{ V}$ ,  $V_{CC-} = 0\text{ V}$ ,  $V_{icm} = V_{CC}/2$ ,  $T = 25\text{ }^{\circ}\text{C}$ ,  $R_L = 10\text{ k}\Omega$  connected to  $V_{CC}/2$ , unless otherwise specified)**

Symbol	Parameter	Conditions	Min.	Typ.	Max.	Unit
<b>DC performance</b>						
$V_{IO}$	Input offset voltage	$T = 25\text{ }^{\circ}\text{C}$		3.5	35	$\mu\text{V}$
		$T_{min} < T < T_{max}$			54	
$ \Delta V_{IO}/\Delta T $	Input offset voltage drift <sup>(1)</sup>	$T_{min} < T < T_{max}$			0.15	$\mu\text{V}/^{\circ}\text{C}$
$I_{IB}$	Input bias current <sup>(2)</sup> ( $V_{OUT} = V_{CC}/2$ )	$T = 25\text{ }^{\circ}\text{C}$		30	200	pA
		$T_{min} < T < T_{max}$			400	
$I_{IO}$	Input offset current <sup>(2)</sup> ( $V_{OUT} = V_{CC}/2$ )	$T = 25\text{ }^{\circ}\text{C}$		60	400	pA
		$T_{min} < T < T_{max}$			600	
CMR1	Common-mode rejection ratio <sup>(3)</sup> , $V_{ic} = 0\text{ V to } V_{CC}$ , $V_{OUT} = V_{CC}/2$ , $R_L > 1\text{ M}\Omega$	$T = 25\text{ }^{\circ}\text{C}$	96	115		dB
		$T_{min} < T < T_{max}$	90			
$A_{vd}$	Large signal voltage gain, $V_{OUT} = 0.5\text{ V to } (V_{CC} - 0.5\text{ V})$	$T = 25\text{ }^{\circ}\text{C}$	112	130		
		$T_{min} < T < T_{max}$	98			
$V_{OH}$	High-level output voltage, $V_{OH} = V_{CC} - V_{OUT}$	$T = 25\text{ }^{\circ}\text{C}$		15	40	mV
		$T_{min} < T < T_{max}$			70	
$V_{OL}$	Low-level output voltage	$T = 25\text{ }^{\circ}\text{C}$		10	30	mV
		$T_{min} < T < T_{max}$			70	
$I_{OUT}$	$I_{sink}$ ( $V_{OUT} = V_{CC}$ )	$T = 25\text{ }^{\circ}\text{C}$	4	6		mA
		$T_{min} < T < T_{max}$	2.37			
	$I_{source}$ ( $V_{OUT} = 0\text{ V}$ )	$T = 25\text{ }^{\circ}\text{C}$	3.5	4		
		$T_{min} < T < T_{max}$	1.9			
$I_{CC}$	Supply current per channel, $V_{OUT} = V_{CC}/2$ , $R_L > 1\text{ M}\Omega$	$T = 25\text{ }^{\circ}\text{C}$		0.7	1	
		$T_{min} < T < T_{max}$			1.2	
<b>AC performance</b>						
GBP	Gain bandwidth product, $R_L = 10\text{ k}\Omega$ , $C_L = 100\text{ pF}$	$T = 25\text{ }^{\circ}\text{C}$	1.6	2.3		MHz
		$T_{min} < T < T_{max}$	1.1			
$\Phi_m$	Phase margin	$R_L = 10\text{ k}\Omega$ , $C_L = 100\text{ pF}$		59		degrees
$G_m$	Gain margin			16		dB
$S_R$	Slew rate <sup>(4)</sup>	$T = 25\text{ }^{\circ}\text{C}$	3	4.6		V/ $\mu\text{s}$
		$T_{min} < T < T_{max}$	2.5			
$t_s$	Settling time	To 0.1%, $V_{in} = 0.8\text{ V}_{pp}$		500		ns
en	Equivalent input noise voltage density	$f = 1\text{ kHz}$		50		nV/ $\sqrt{\text{Hz}}$
		$f = 10\text{ kHz}$		50		
en-pp	Voltage noise	$f = 0.1\text{ to } 10\text{ Hz}$		0.6		$\mu\text{V}_{pp}$
$C_s$	Channel separation	$f = 1\text{ kHz}$		120		dB

Symbol	Parameter	Conditions	Min.	Typ.	Max.	Unit
$t_{init}$	Initialization time, $G = 100^{(5)}$	$T = 25\text{ °C}$		60		$\mu\text{s}$
		$T_{min} < T < T_{max}$		100		

1. Input offset measurements are performed on x100 gain configuration. The amplifiers and the gain setting resistors are at the same temperature.
2. Guaranteed by design.
3. CMR is defined as  $20 \times \text{LOG}(\Delta_{V_{icm}}/\Delta_{V_{io}})$ .
4. Slew rate value is calculated as the average between positive and negative slew rates.
5. Initialization time is defined as the delay between the moment when supply voltage exceeds 2.2 V and output voltage stabilization.

**Table 4. Electrical characteristics ( $V_{CC+} = 3.3\text{ V}$ ,  $V_{CC-} = 0\text{ V}$ ,  $V_{icm} = V_{CC}/2$ ,  $T = 25\text{ }^{\circ}\text{C}$ ,  $R_L = 10\text{ k}\Omega$  connected to  $V_{CC}/2$ , unless otherwise specified)**

Symbol	Parameter	Conditions	Min.	Typ.	Max.	Unit
<b>DC performance</b>						
$V_{IO}$	Input offset voltage	$T = 25\text{ }^{\circ}\text{C}$		2	30	$\mu\text{V}$
		$T_{min} < T < T_{max}$			49	
$ \Delta V_{IO}/\Delta T $	Input offset voltage drift <sup>(1)</sup>	$T_{min} < T < T_{max}$			0.15	$\mu\text{V}/^{\circ}\text{C}$
$I_{IB}$	Input bias current ( $V_{OUT} = V_{CC}/2$ )	$T = 25\text{ }^{\circ}\text{C}$		30	200	pA
		$T_{min} < T < T_{max}$			400	
$I_{IO}$	Input offset current <sup>(2)</sup> ( $V_{OUT} = V_{CC}/2$ )	$T = 25\text{ }^{\circ}\text{C}$		60	400	pA
		$T_{min} < T < T_{max}$			600	
CMR1	Common-mode rejection ratio <sup>(3)</sup> , $V_{ic} = 0\text{ V to } V_{CC}$ , $V_{OUT} = V_{CC}/2$ , $R_L > 1\text{ M}\Omega$	$T = 25\text{ }^{\circ}\text{C}$	104	120		dB
		$T_{min} < T < T_{max}$	100			
CMR2	Common-mode rejection ratio <sup>(3)</sup> , $V_{OUT} = V_{CC}/2$ , $R_L > 1\text{ M}\Omega$	$T = 25\text{ }^{\circ}\text{C}$ , $V_{ic} = 0\text{ to } V_{CC} - 1.8\text{ V}$	106	132		dB
		$T_{min} < T < T_{max}$ , $V_{ic} = 0\text{ to } V_{CC} - 2\text{ V}$	104			
$A_{vd}$	Large signal voltage gain, $V_{OUT} = 0.5\text{ V to } (V_{CC} - 0.5\text{ V})$	$T = 25\text{ }^{\circ}\text{C}$	120	138		
		$T_{min} < T < T_{max}$	110			
$V_{OH}$	High-level output voltage, $V_{OH} = V_{CC} - V_{OUT}$	$T = 25\text{ }^{\circ}\text{C}$		16	40	mV
		$T_{min} < T < T_{max}$			70	
$V_{OL}$	Low-level output voltage	$T = 25\text{ }^{\circ}\text{C}$		11	30	mV
		$T_{min} < T < T_{max}$			70	
$I_{OUT}$	$I_{sink}$ ( $V_{OUT} = V_{CC}$ )	$T = 25\text{ }^{\circ}\text{C}$	10	15		mA
		$T_{min} < T < T_{max}$	7.1			
	$I_{source}$ ( $V_{OUT} = 0\text{ V}$ )	$T = 25\text{ }^{\circ}\text{C}$	6	11		
		$T_{min} < T < T_{max}$	3.8			
$I_{CC}$	Supply current per channel, $V_{OUT} = V_{CC}/2$ , $R_L > 1\text{ M}\Omega$	$T = 25\text{ }^{\circ}\text{C}$		0.7	1	
		$T_{min} < T < T_{max}$			1.2	
<b>AC performance</b>						
GBP	Gain bandwidth product, $R_L = 10\text{ k}\Omega$ , $C_L = 100\text{ pF}$	$T = 25\text{ }^{\circ}\text{C}$	2	2.8		MHz
		$T_{min} < T < T_{max}$	1.5			
$\Phi_m$	Phase margin	$R_L = 10\text{ k}\Omega$ , $C_L = 100\text{ pF}$		56		degrees
$G_m$	Gain margin			15		dB
SR	Slew rate <sup>(4)</sup>	$T = 25\text{ }^{\circ}\text{C}$	2.6	4.5		$\text{V}/\mu\text{s}$
		$T_{min} < T < T_{max}$	2.1			
$t_s$	Settling time	To 0.1%, $V_{in} = 1.2\text{ V}_{pp}$		550		ns
$e_n$	Equivalent input noise voltage density	$f = 1\text{ kHz}$		40		$\text{nV}/\sqrt{\text{Hz}}$
		$f = 10\text{ kHz}$		40		
$e_{n-pp}$	Voltage noise	$f = 0.1\text{ to } 10\text{ Hz}$		0.5		$\mu\text{V}_{pp}$
$C_s$	Channel separation	$f = 1\text{ kHz}$		120		dB

Symbol	Parameter	Conditions	Min.	Typ.	Max.	Unit
$t_{\text{int}}$	Initialization time, G=100 <sup>(5)</sup>	T = 25 °C		60		μs
		Tmin < T < Tmax		100		

1. Input offset measurements are performed on x100 gain configuration. The amplifiers and the gain setting resistors are at the same temperature.
2. Guaranteed by design.
3. CMR is defined as  $20 \times \text{LOG}(\Delta_{V_{\text{icm}}}/\Delta_{V_{\text{io}}})$ .
4. Slew rate value is calculated as the average between positive and negative slew rates.
5. Initialization time is defined as the delay between the moment when supply voltage exceeds 2.2 V and output voltage stabilization.

**Table 5. Electrical characteristics ( $V_{CC+} = 5\text{ V}$ ,  $V_{CC-} = 0\text{ V}$ ,  $V_{icm} = V_{CC}/2$ ,  $T = 25\text{ }^\circ\text{C}$ ,  $R_L = 10\text{ k}\Omega$  connected to  $V_{CC}/2$ , unless otherwise specified)**

Symbol	Parameter	Conditions	Min.	Typ.	Max.	Unit
<b>DC performance</b>						
$V_{IO}$	Input offset voltage	$T = 25\text{ }^\circ\text{C}$		1	25	$\mu\text{V}$
		$T_{min} < T < T_{max}$			44	
$ \Delta V_{IO}/\Delta T $	Input offset voltage drift <sup>(1)</sup>	$T_{min} < T < T_{max}$			0.15	$\mu\text{V}/^\circ\text{C}$
$I_{IB}$	Input bias current <sup>(2)</sup> ( $V_{OUT} = V_{CC}/2$ )	$T = 25\text{ }^\circ\text{C}$		30	200	pA
		$T_{min} < T < T_{max}$			400	
$I_{IO}$	Input offset current <sup>(2)</sup> ( $V_{OUT} = V_{CC}/2$ )	$T = 25\text{ }^\circ\text{C}$		60	400	pA
		$T_{min} < T < T_{max}$			600	
CMR1	Common-mode rejection ratio <sup>(3)</sup> , $V_{ic} = 0\text{ V to } V_{CC}$ , $V_{OUT} = V_{CC}/2$ , $R_L > 1\text{ M}\Omega$	$T = 25\text{ }^\circ\text{C}$	108	126		dB
		$T_{min} < T < T_{max}$	106			
CMR2	Common-mode rejection ratio <sup>(3)</sup> , $V_{ic} = 0\text{ V to } V_{CC}$ , $V_{OUT} = V_{CC}/2$ , $R_L > 1\text{ M}\Omega$	$T = 25\text{ }^\circ\text{C}$ , $V_{ic} = 0\text{ to } V_{CC} - 1.8\text{ V}$	112	136		dB
		$T_{min} < T < T_{max}$ , $V_{ic} = 0\text{ to } V_{CC} - 2\text{ V}$	110			
SVR1	Supply voltage rejection ratio $V_{CC} = 2.2\text{ to } 5.5\text{ V}$ , $V_{ic} = 0\text{ V}$ , $R_L > 1\text{ M}\Omega$	$T = 25\text{ }^\circ\text{C}$	105	123		dB
		$T_{min} < T < T_{max}$	104			
$A_{vd}$	Large signal voltage gain, $V_{OUT} = 0.5\text{ V to } (V_{CC} - 0.5\text{ V})$	$T = 25\text{ }^\circ\text{C}$	120	144		dB
		$T_{min} < T < T_{max}$	110			
EMIRR	EMI rejection ratio <sup>(5)</sup>	$V_{RF} = 100\text{ mVp}$ , $f = 400\text{ MHz}$		52		dB
		$V_{RF} = 100\text{ mVp}$ , $f = 900\text{ MHz}$		52		
		$V_{RF} = 100\text{ mVp}$ , $f = 1800\text{ MHz}$		72		
		$V_{RF} = 100\text{ mVp}$ , $f = 2400\text{ MHz}$		85		
$V_{OH}$	High-level output voltage, $V_{OH} = V_{CC} - V_{OUT}$	$T = 25\text{ }^\circ\text{C}$		18	40	mV
		$T_{min} < T < T_{max}$			70	
$V_{OL}$	Low-level output voltage	$T = 25\text{ }^\circ\text{C}$		13	30	mV
		$T_{min} < T < T_{max}$			70	
$I_{OUT}$	$I_{sink}$ ( $V_{OUT} = V_{CC}$ )	$T = 25\text{ }^\circ\text{C}$	20	29		mA
		$T_{min} < T < T_{max}$	14			
	$I_{source}$ ( $V_{OUT} = 0\text{ V}$ )	$T = 25\text{ }^\circ\text{C}$	15	25		
		$T_{min} < T < T_{max}$	9			
$I_{CC}$	Supply current per channel, $V_{OUT} = V_{CC}/2$ , $R_L > 1\text{ M}\Omega$	$T = 25\text{ }^\circ\text{C}$		0.8	1	mA
		$T_{min} < T < T_{max}$			1.2	
<b>AC performance</b>						
GBP	Gain bandwidth product, $R_L = 10\text{ k}\Omega$ , $C_L = 100\text{ pF}$	$T = 25\text{ }^\circ\text{C}$	2	3		MHz
		$T_{min} < T < T_{max}$	1.5			
$\Phi_m$	Phase margin	$R_L = 10\text{ k}\Omega$ , $C_L = 100\text{ pF}$		56		Degrees
$G_m$	Gain margin			15		dB
SR	Slew rate <sup>(6)</sup>	$T = 25\text{ }^\circ\text{C}$	2.9	4.7		$\text{V}/\mu\text{s}$



Symbol	Parameter	Conditions	Min.	Typ.	Max.	Unit
SR	Slew rate <sup>(6)</sup>	Tmin < T < Tmax	2.4			V/μs
t <sub>s</sub>	Settling time	To 0.1%, Vin=1.5 Vpp		600		ns
		To 0.01%, Vin=1 Vpp		4		μs
e <sub>n</sub>	Equivalent input noise voltage density	f = 1 kHz		37		nV/√Hz
		f = 10 kHz		37		
en-pp	Voltage noise	f=0.1 to 10 Hz		0.4		μVpp
C <sub>s</sub>	Channel separation	f = 100 Hz		135		dB
t <sub>init</sub>	Initialization time, G=100 <sup>(7)</sup>	T = 25 °C		60		μs
		Tmin < T < Tmax		100		

1. Input offset measurements are performed on x100 gain configuration. The amplifiers and the gain setting resistors are at the same temperature.
2. Guaranteed by design
3. CMR is defined as  $20 \times \text{LOG}(\Delta V_{icm} / \Delta V_{io})$ .
4. SVR is defined as  $20 \times \text{LOG}(\Delta V_{cc} / \Delta V_{io})$ .
5. EMIRR is defined as  $-20 \text{Log}(VRF\_Peak / \Delta V_{io})$ , tested on the MiniSO8 package, RF injection on the IN- pin.
6. Slew rate value is calculated as the average between positive and negative slew rates.
7. Initialization time is defined as the delay between the moment when supply voltage exceeds 2.2 V and output voltage stabilization.

**Figure 2. Supply current vs supply voltage**

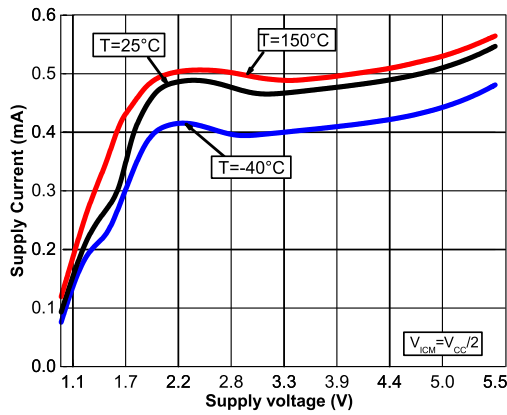

**Figure 3. Input offset voltage distribution at  $V_{CC} = 5\text{ V}$**

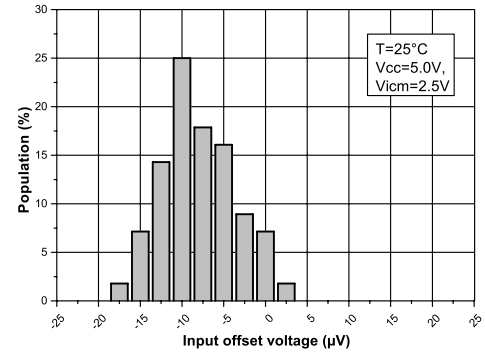

**Figure 4. Input offset voltage distribution at  $V_{CC} = 3.3\text{ V}$**

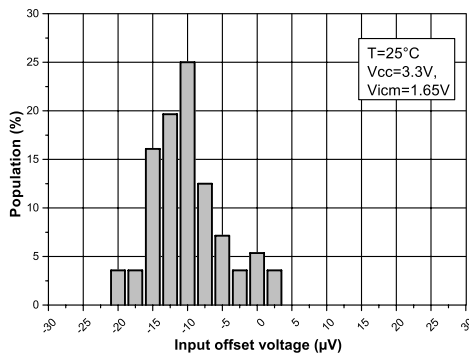

**Figure 5. Input offset voltage distribution at  $V_{CC} = 2.2\text{ V}$**

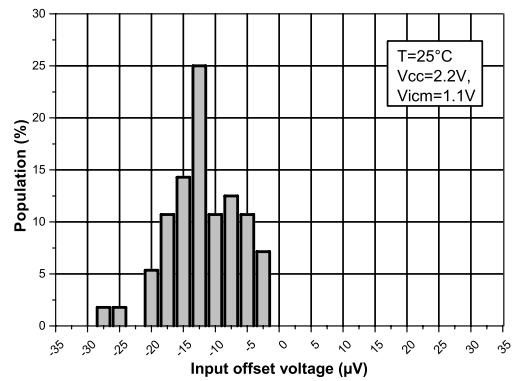

**Figure 6. Input offset voltage distribution at  $V_{CC} = 5\text{ V}$ ,  $T = 150^{\circ}\text{C}$**

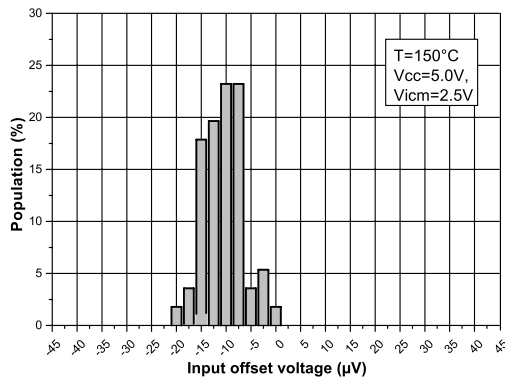

**Figure 7. Input offset voltage distribution at  $V_{CC} = 5\text{ V}$ ,  $T = -40^{\circ}\text{C}$**

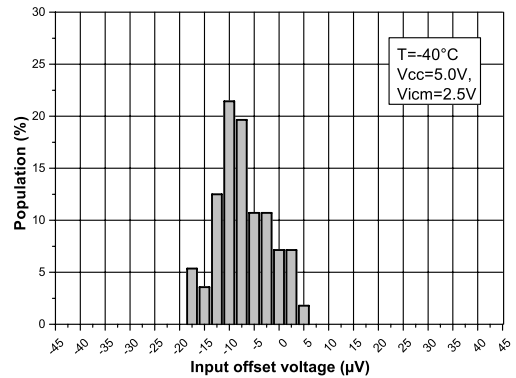

**Figure 8. Input offset voltage distribution at  $V_{CC}=2.2\text{ V}$ ,  $T = 150\text{ }^{\circ}\text{C}$**

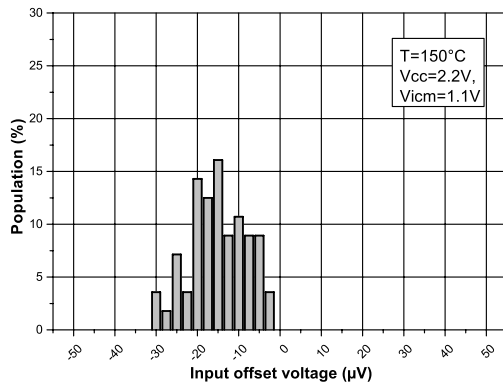

**Figure 9. Input offset voltage distribution at  $V_{CC}=2.2\text{ V}$ ,  $T = -40\text{ }^{\circ}\text{C}$**

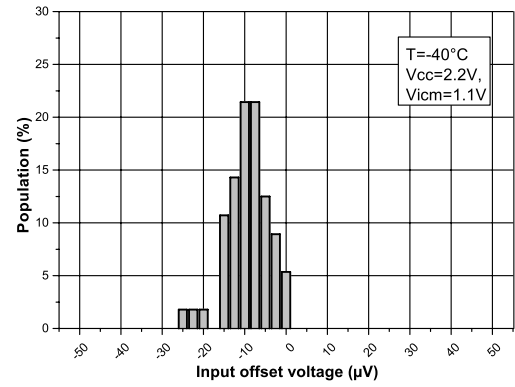

**Figure 10. Input offset voltage vs supply voltage**

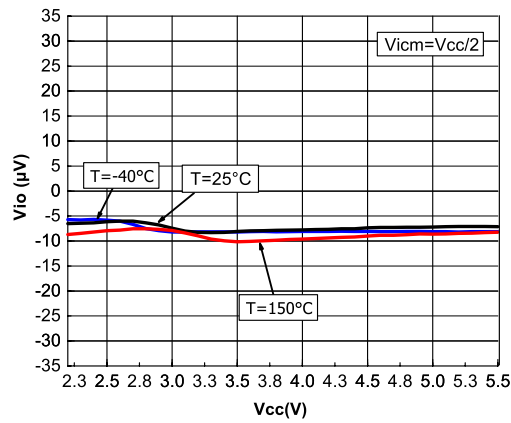

**Figure 11. Input offset voltage vs input common mode at  $V_{CC}=5\text{ V}$**

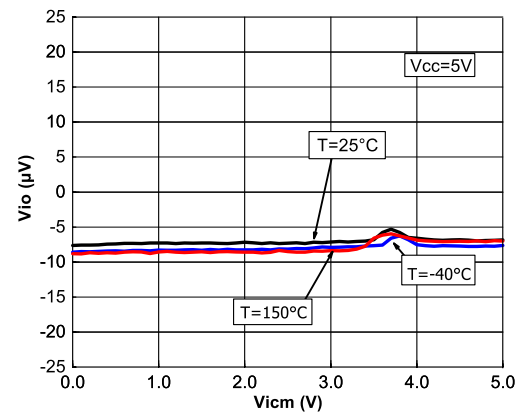

**Figure 12. Input offset voltage vs input common mode at  $V_{CC}=3.3\text{ V}$**

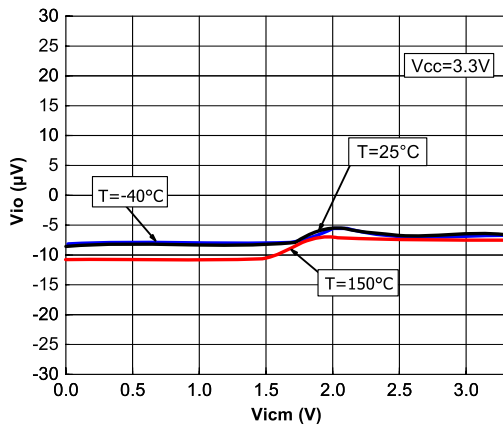

**Figure 13. Input offset voltage vs input common mode at  $V_{CC}=2.2\text{ V}$**

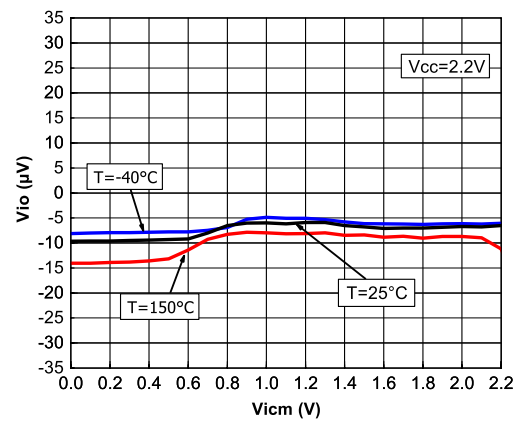

Figure 14. Input offset voltage vs temperature

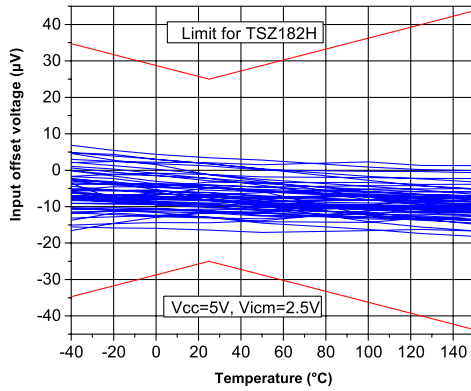

Figure 15.  $V_{OH}$  vs supply voltage

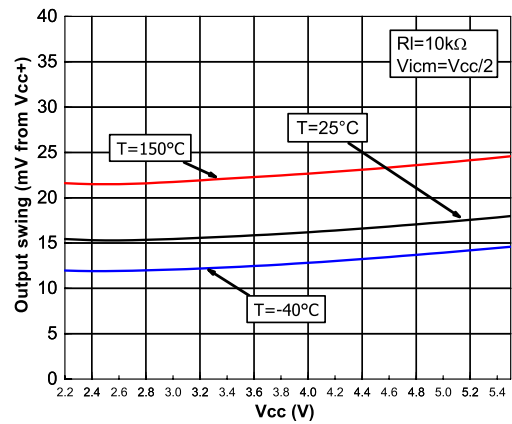

Figure 16.  $V_{OL}$  vs supply voltage

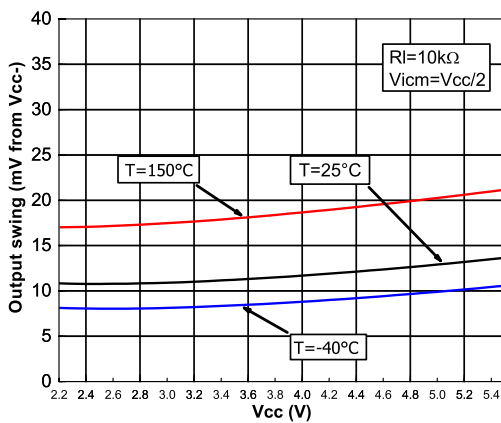

Figure 17. Output current vs output voltage at  $V_{CC} = 5\text{ V}$

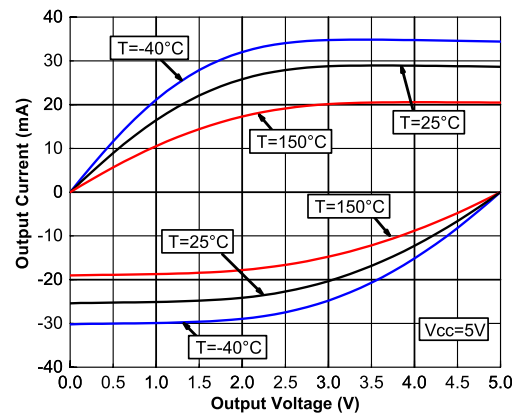

Figure 18. Output current vs. output voltage at  $V_{CC} = 2.2\text{ V}$

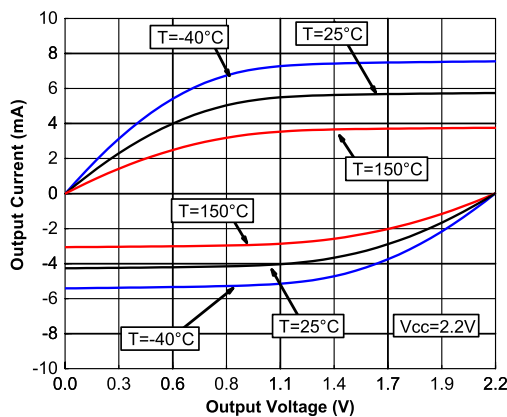

Figure 19. Input bias current vs common-mode at  $V_{CC} = 5\text{ V}$

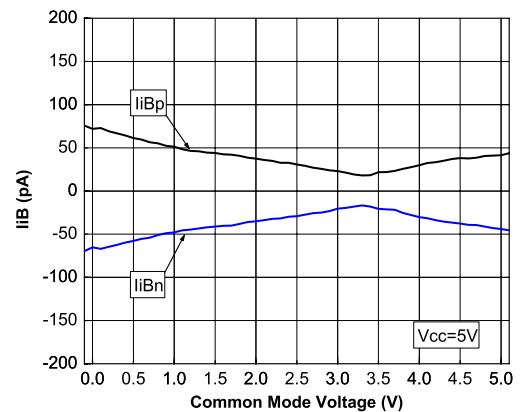

Figure 20. Input bias current vs. temperature at  $V_{CC} = 5\text{ V}$

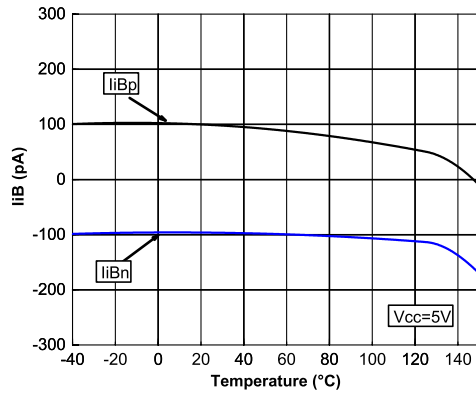

Figure 21. Output rail linearity

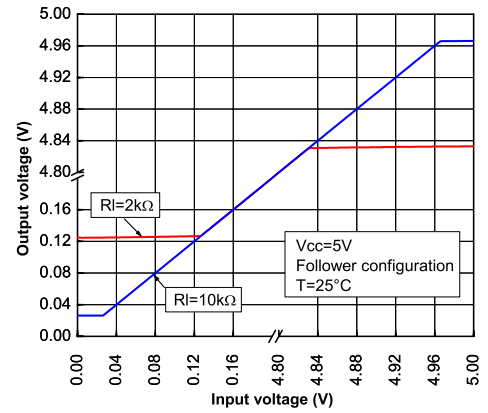

Figure 22. Bode diagram at  $V_{CC}=5\text{ V}$

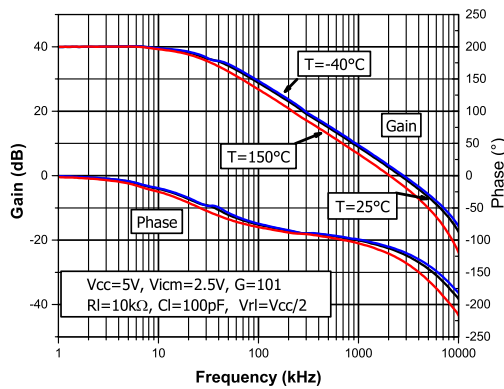

Figure 23. Bode diagram at  $V_{CC}=2.2\text{ V}$

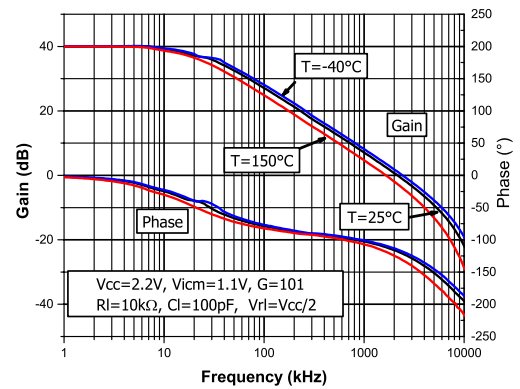

Figure 24. Bode diagram at  $V_{CC}=3.3\text{ V}$

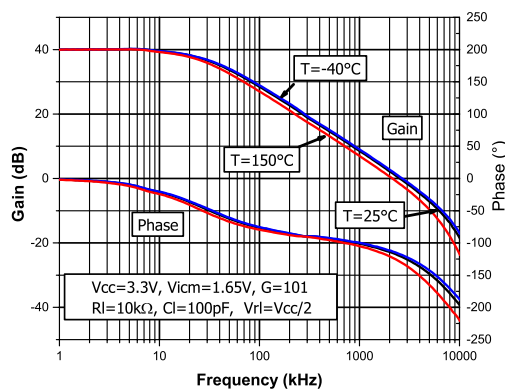

Figure 25. Open loop gain vs frequency

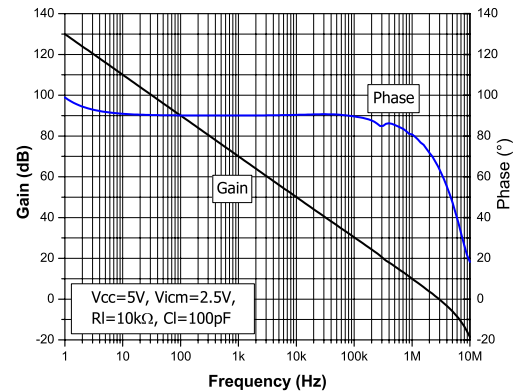

Figure 26. Positive slew rate vs supply voltage

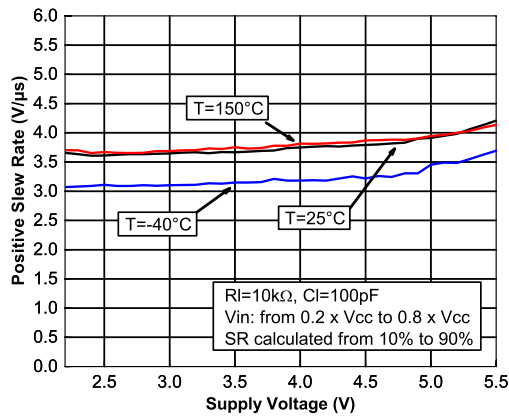

Figure 27. Negative slew rate vs supply voltage

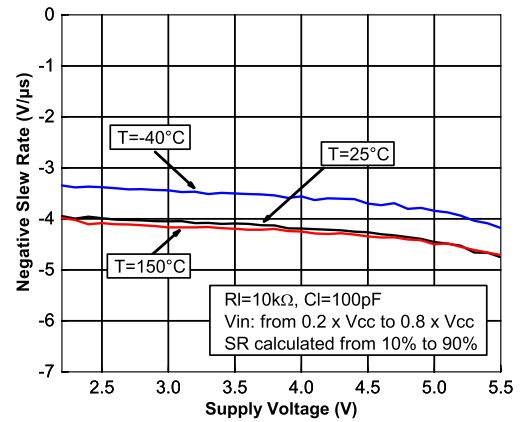

Figure 28. Noise 0.1 – 10 Hz vs time

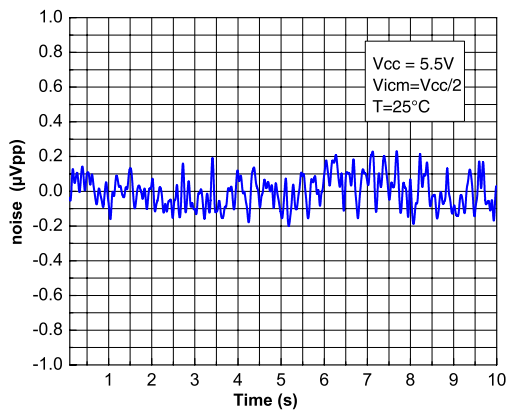

Figure 29. Noise vs frequency

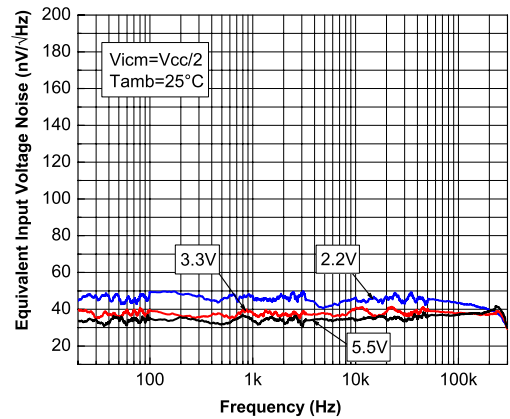

Figure 30. Output overshoot vs load capacitance

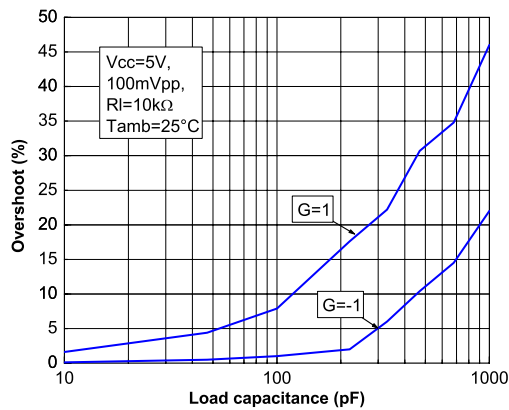

Figure 31. Small signal  $V_{CC} = 5\text{V}$

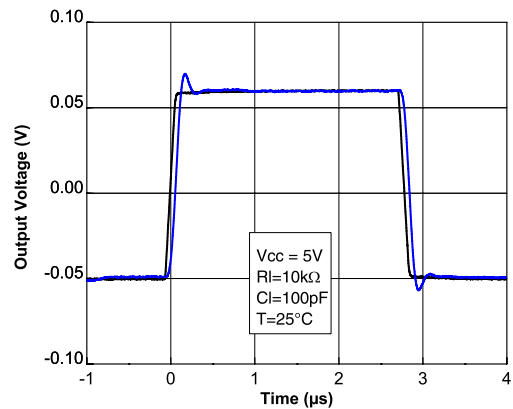

Figure 32. Small signal  $V_{CC} = 2.2\text{ V}$

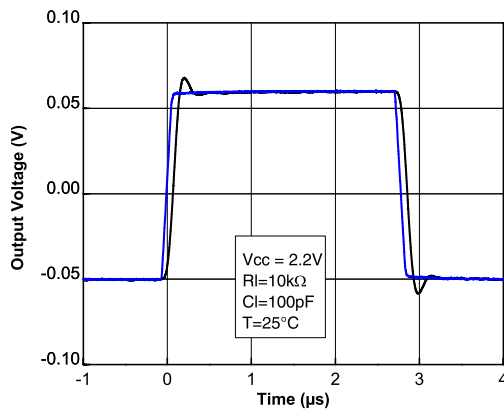

Figure 33. Large signal  $V_{CC} = 5\text{ V}$

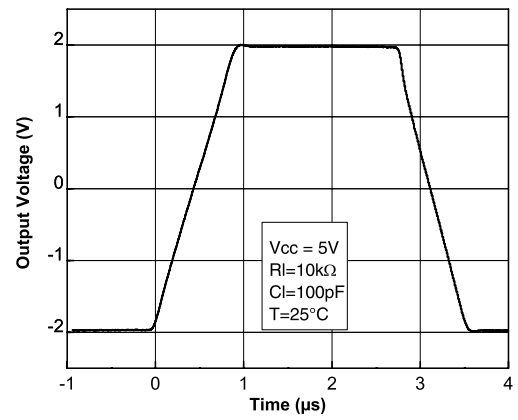

Figure 34. Large signal  $V_{CC} = 2.2\text{ V}$

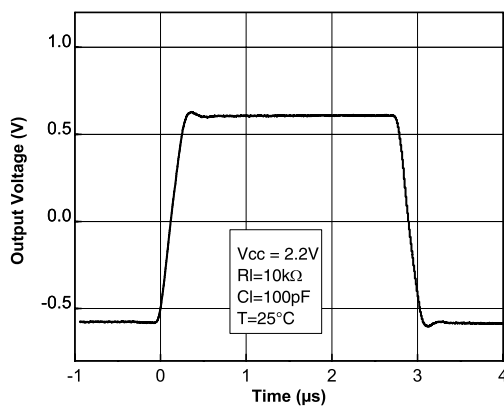

Figure 35. Negative overvoltage recovery  
 $V_{CC} = 2.2\text{ V}$

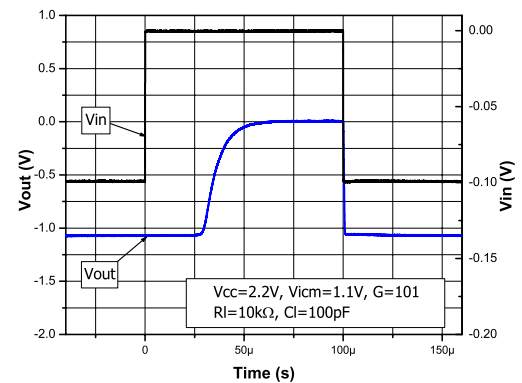

Figure 36. Positive overvoltage recovery  $V_{CC} = 5\text{ V}$

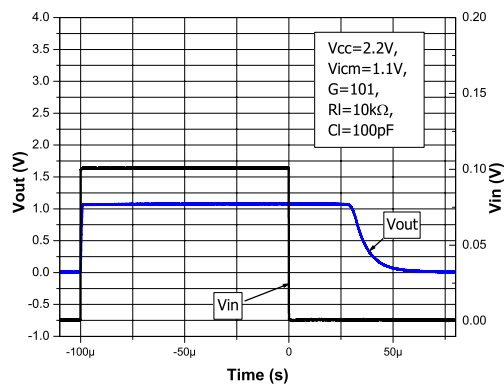

Figure 37. Output impedance vs frequency

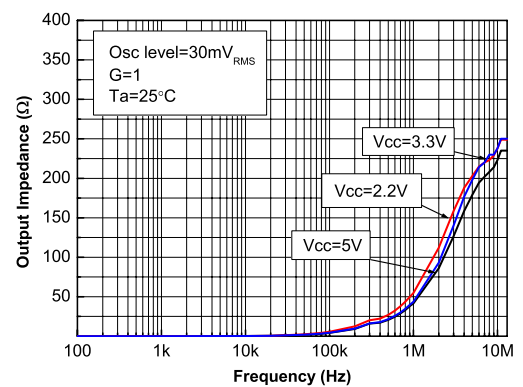

Figure 38. Settling time positive step (-2 V to 0 V)

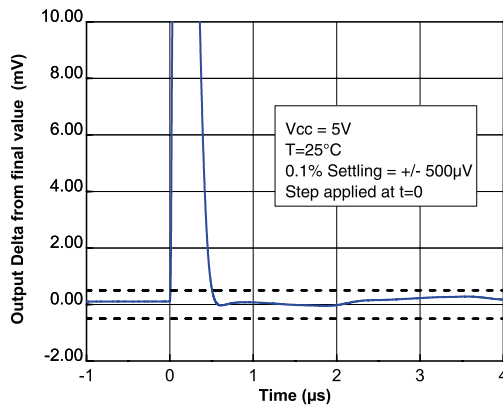

Figure 39. Settling time negative step (2 V to 0 V)

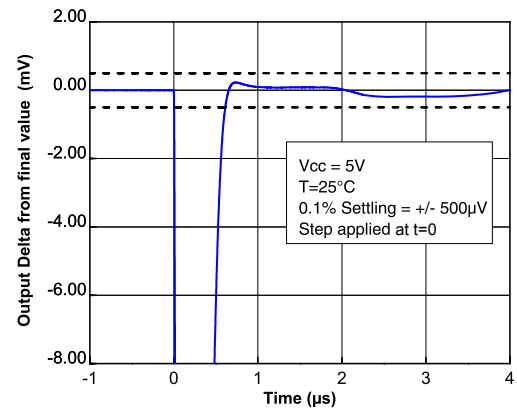

Figure 40. Settling time positive step (-0.8 V to 0 V)

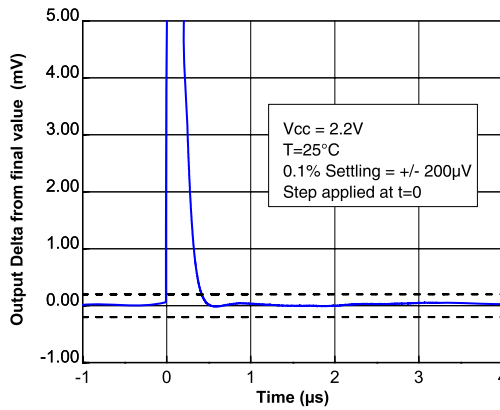

Figure 41. Settling time negative step (0.8 V to 0 V)

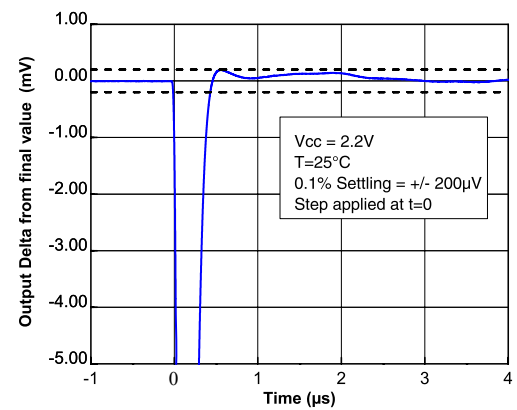

Figure 42. Maximum output voltage vs frequency

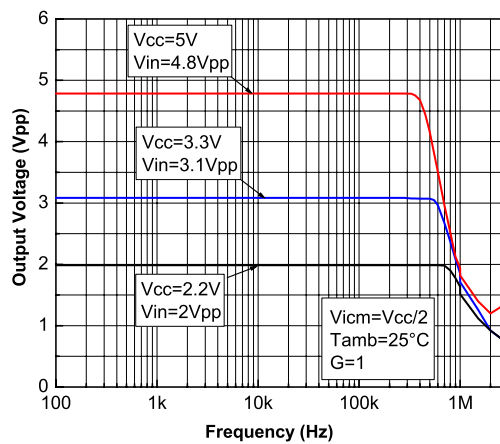

Figure 43. Crosstalk vs frequency

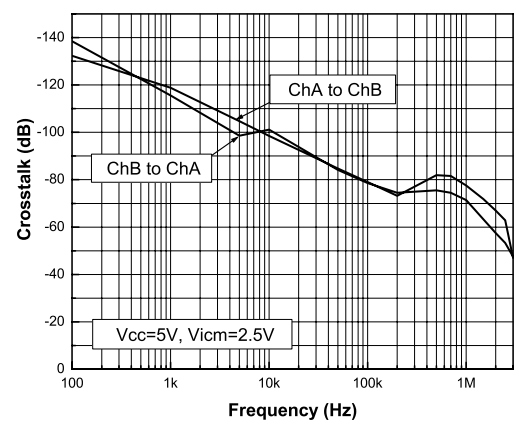
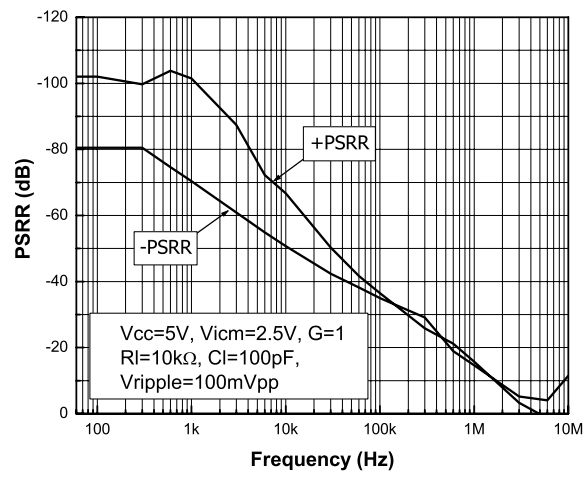



Figure 44. PSSR vs frequency



## 4 Package information

In order to meet environmental requirements, ST offers these devices in different grades of **ECOPACK** packages, depending on their level of environmental compliance. ECOPACK specifications, grade definitions and product status are available at: [www.st.com](http://www.st.com). ECOPACK is an ST trademark.

### 4.1 SO8 package information

**Figure 45. SO8 package outline**

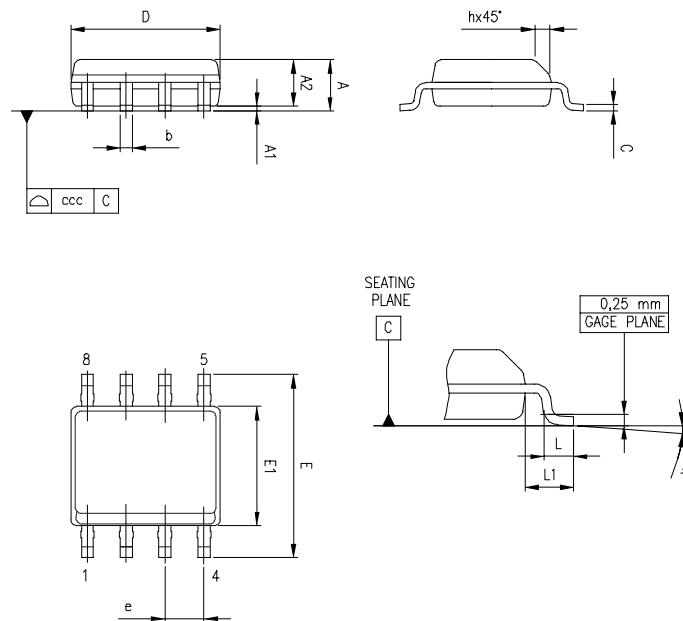

**Table 6. SO-8 mechanical data**

Dim.	mm			Inches		
	Min.	Typ.	Max.	Min.	Typ.	Max.
A			1.75			0.069
A1	0.1		0.25	0.004		0.01
A2	1.25			0.049		
b	0.28		0.48	0.011		0.019
c	0.17		0.23	0.007		0.01
D	4.8	4.9	5	0.189	0.193	0.197
E	5.8	6	6.2	0.228	0.236	0.244
E1	3.8	3.9	4	0.15	0.154	0.157
e		1.27			0.05	
h	0.25		0.5	0.01		0.02
L	0.4		1.27	0.016		0.05
L1		1.04			0.04	
k	0		8 °	1 °		8 °

Dim.	mm			Inches		
	Min.	Typ.	Max.	Min.	Typ.	Max.
ccc			0.1			0.004

## 4.2 SOT23-5 package information

Figure 46. SOT23-5 package outline

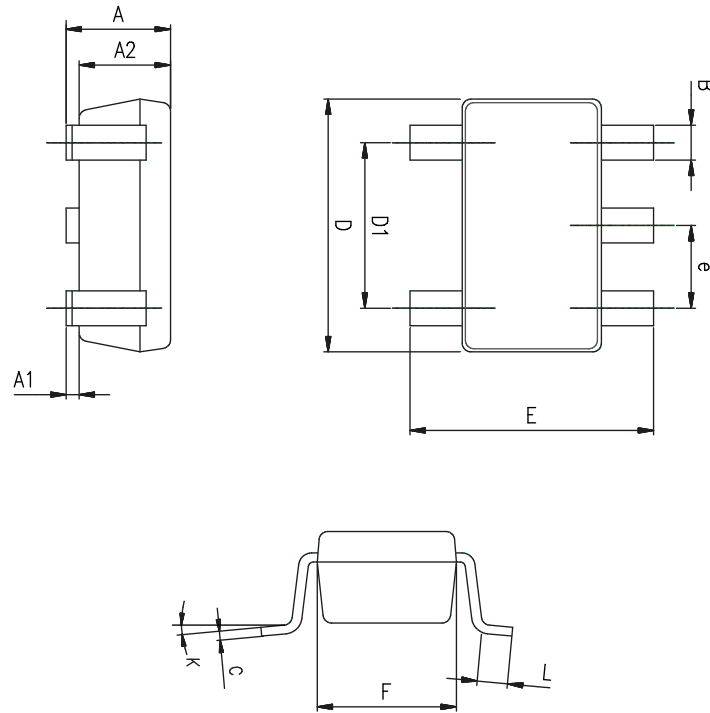

Table 7. SOT23-5 mechanical data

Ref.	Dimensions					
	Millimeters			Inches		
	Min.	Typ.	Max.	Min.	Typ.	Max.
A	0.90	1.20	1.45	0.035	0.047	0.057
A1			0.15			0.006
A2	0.90	1.05	1.30	0.035	0.041	0.051
B	0.35	0.40	0.50	0.014	0.016	0.020
C	0.09	0.15	0.20	0.004	0.006	0.008
D	2.80	2.90	3.00	0.110	0.114	0.118
D1		1.90			0.075	
e		0.95			0.037	
E	2.60	2.80	3.00	0.102	0.110	0.118
F	1.50	1.60	1.75	0.059	0.063	0.069
L	0.10	0.35	0.60	0.004	0.014	0.024
K	0 degrees		10 degrees	0 degrees		10 degrees

## 5 Ordering information

**Table 8. Ordering information**

Order code	Package	Packing	Marking
TSZ182HYDT <sup>(1)</sup>	SO8	Tape and reel	TSZ182H
TSZ181HYLT <sup>(1)</sup>	SOT23-5		K229

1. Qualified and characterized according to AEC Q100 and Q003 or equivalent, advanced screening according to AEC Q001 & Q002 or equivalent.

## Revision history

**Table 9. Document revision history**

Date	Version	Changes
20-Jan-2020	1	Initial release.
09-Dec-2020	2	Added new part number TSZ181H and new <a href="#">Section 4.2 SOT23-5 package information</a> Updated package figure on the cover page, <a href="#">Figure 1</a> and new order code in <a href="#">Table 8</a> .

---

## Contents

<b>1</b>	<b>Package pin connections</b> .....	<b>2</b>
<b>2</b>	<b>Absolute maximum ratings and operation conditions</b> .....	<b>3</b>
<b>3</b>	<b>Electrical characteristics</b> .....	<b>4</b>
<b>4</b>	<b>Package information</b> .....	<b>18</b>
<b>4.1</b>	<b>SO8 package information</b> .....	<b>18</b>
<b>4.2</b>	<b>SOT23-5 package information</b> .....	<b>20</b>
<b>5</b>	<b>Ordering information</b> .....	<b>21</b>
	<b>Revision history</b> .....	<b>22</b>

## List of tables

<b>Table 1.</b>	Absolute maximum ratings . . . . .	3
<b>Table 2.</b>	Operating conditions . . . . .	3
<b>Table 3.</b>	Electrical characteristics ( $V_{CC+} = 2.2\text{ V}$ , $V_{CC-} = 0\text{ V}$ , $V_{icm} = V_{CC}/2$ , $T = 25\text{ }^{\circ}\text{C}$ , $R_L = 10\text{ k}\Omega$ connected to $V_{CC}/2$ , unless otherwise specified) . . . . .	4
<b>Table 4.</b>	Electrical characteristics ( $V_{CC+} = 3.3\text{ V}$ , $V_{CC-} = 0\text{ V}$ , $V_{icm} = V_{CC}/2$ , $T = 25\text{ }^{\circ}\text{C}$ , $R_L = 10\text{ k}\Omega$ connected to $V_{CC}/2$ , unless otherwise specified) . . . . .	6
<b>Table 5.</b>	Electrical characteristics ( $V_{CC+} = 5\text{ V}$ , $V_{CC-} = 0\text{ V}$ , $V_{icm} = V_{CC}/2$ , $T = 25\text{ }^{\circ}\text{C}$ , $R_L = 10\text{ k}\Omega$ connected to $V_{CC}/2$ , unless otherwise specified) . . . . .	8
<b>Table 6.</b>	SO-8 mechanical data . . . . .	18
<b>Table 7.</b>	SOT23-5 mechanical data . . . . .	20
<b>Table 8.</b>	Ordering information . . . . .	21
<b>Table 9.</b>	Document revision history . . . . .	22



## List of figures

<b>Figure 1.</b>	Pin connections (top view) . . . . .	2
<b>Figure 2.</b>	Supply current vs supply voltage . . . . .	10
<b>Figure 3.</b>	Input offset voltage distribution at $V_{CC} = 5\text{ V}$ . . . . .	10
<b>Figure 4.</b>	Input offset voltage distribution at $V_{CC} = 3.3\text{ V}$ . . . . .	10
<b>Figure 5.</b>	Input offset voltage distribution at $V_{CC} = 2.2\text{ V}$ . . . . .	10
<b>Figure 6.</b>	Input offset voltage distribution at $V_{CC} = 5\text{ V}$ , $T = 150\text{ }^{\circ}\text{C}$ . . . . .	10
<b>Figure 7.</b>	Input offset voltage distribution at $V_{CC} = 5\text{ V}$ , $T = -40\text{ }^{\circ}\text{C}$ . . . . .	10
<b>Figure 8.</b>	Input offset voltage distribution at $V_{CC}=2.2\text{ V}$ , $T = 150\text{ }^{\circ}\text{C}$ . . . . .	11
<b>Figure 9.</b>	Input offset voltage distribution at $V_{CC}=2.2\text{ V}$ , $T = -40\text{ }^{\circ}\text{C}$ . . . . .	11
<b>Figure 10.</b>	Input offset voltage vs supply voltage . . . . .	11
<b>Figure 11.</b>	Input offset voltage vs input common mode at $V_{CC}= 5\text{ V}$ . . . . .	11
<b>Figure 12.</b>	Input offset voltage vs input common mode at $V_{CC}= 3.3\text{ V}$ . . . . .	11
<b>Figure 13.</b>	Input offset voltage vs input common mode at $V_{CC}= 2.2\text{ V}$ . . . . .	11
<b>Figure 14.</b>	Input offset voltage vs temperature . . . . .	12
<b>Figure 15.</b>	$V_{OH}$ vs supply voltage . . . . .	12
<b>Figure 16.</b>	$V_{OL}$ vs supply voltage . . . . .	12
<b>Figure 17.</b>	Output current vs output voltage at $V_{CC} = 5\text{ V}$ . . . . .	12
<b>Figure 18.</b>	Output current vs. output voltage at $V_{CC} = 2.2\text{ V}$ . . . . .	12
<b>Figure 19.</b>	Input bias current vs common-mode at $V_{CC} = 5\text{ V}$ . . . . .	12
<b>Figure 20.</b>	Input bias current vs. temperature at $V_{CC} = 5\text{ V}$ . . . . .	13
<b>Figure 21.</b>	Output rail linearity . . . . .	13
<b>Figure 22.</b>	Bode diagram at $V_{CC}=5\text{ V}$ . . . . .	13
<b>Figure 23.</b>	Bode diagram at $V_{CC}=2.2\text{ V}$ . . . . .	13
<b>Figure 24.</b>	Bode diagram at $V_{CC}=3.3\text{ V}$ . . . . .	13
<b>Figure 25.</b>	Open loop gain vs frequency . . . . .	13
<b>Figure 26.</b>	Positive slew rate vs supply voltage . . . . .	14
<b>Figure 27.</b>	Negative slew rate vs supply voltage . . . . .	14
<b>Figure 28.</b>	Noise 0.1 – 10 Hz vs time . . . . .	14
<b>Figure 29.</b>	Noise vs frequency . . . . .	14
<b>Figure 30.</b>	Output overshoot vs load capacitance . . . . .	14
<b>Figure 31.</b>	Small signal $V_{CC} = 5\text{ V}$ . . . . .	14
<b>Figure 32.</b>	Small signal $V_{CC} = 2.2\text{ V}$ . . . . .	15
<b>Figure 33.</b>	Large signal $V_{CC} = 5\text{ V}$ . . . . .	15
<b>Figure 34.</b>	Large signal $V_{CC} = 2.2\text{ V}$ . . . . .	15
<b>Figure 35.</b>	Negative overvoltage recovery $V_{CC} = 2.2\text{ V}$ . . . . .	15
<b>Figure 36.</b>	Positive overvoltage recovery $V_{CC} = 5\text{ V}$ . . . . .	15
<b>Figure 37.</b>	Output impedance vs frequency . . . . .	15
<b>Figure 38.</b>	Settling time positive step (-2 V to 0 V) . . . . .	16
<b>Figure 39.</b>	Settling time negative step (2 V to 0 V) . . . . .	16
<b>Figure 40.</b>	Settling time positive step (-0.8 V to 0 V) . . . . .	16
<b>Figure 41.</b>	Settling time negative step (0.8 V to 0 V) . . . . .	16
<b>Figure 42.</b>	Maximum output voltage vs frequency . . . . .	16
<b>Figure 43.</b>	Crosstalk vs frequency . . . . .	16
<b>Figure 44.</b>	PSSR vs frequency . . . . .	17
<b>Figure 45.</b>	SO8 package outline . . . . .	18
<b>Figure 46.</b>	SOT23-5 package outline . . . . .	20

**IMPORTANT NOTICE – PLEASE READ CAREFULLY**

STMicroelectronics NV and its subsidiaries (“ST”) reserve the right to make changes, corrections, enhancements, modifications, and improvements to ST products and/or to this document at any time without notice. Purchasers should obtain the latest relevant information on ST products before placing orders. ST products are sold pursuant to ST’s terms and conditions of sale in place at the time of order acknowledgement.

Purchasers are solely responsible for the choice, selection, and use of ST products and ST assumes no liability for application assistance or the design of Purchasers’ products.

No license, express or implied, to any intellectual property right is granted by ST herein.

Resale of ST products with provisions different from the information set forth herein shall void any warranty granted by ST for such product.

ST and the ST logo are trademarks of ST. For additional information about ST trademarks, please refer to [www.st.com/trademarks](http://www.st.com/trademarks). All other product or service names are the property of their respective owners.

Information in this document supersedes and replaces information previously supplied in any prior versions of this document.

© 2020 STMicroelectronics – All rights reserved