

CN-M RELAYS

Middle Load Relay for Smart J/B

< Protective construction >
Sealed

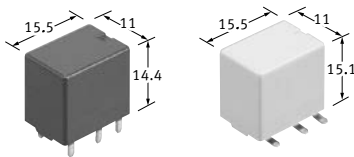

(Unit: mm)

FEATURES

- Space saving most suitable for smart J/B
- Compact and high-capacity 30 A load switching.
- Full line up (High heat-resistant type and SMD type)
- Terminals for PC board pattern designs are easily allocated.

TYPICAL APPLICATIONS

- Defogger, Seat heater, Head lamp, Fog lamp and Fan motor, etc.

ORDERING INFORMATION (PART NO.)

ACNM

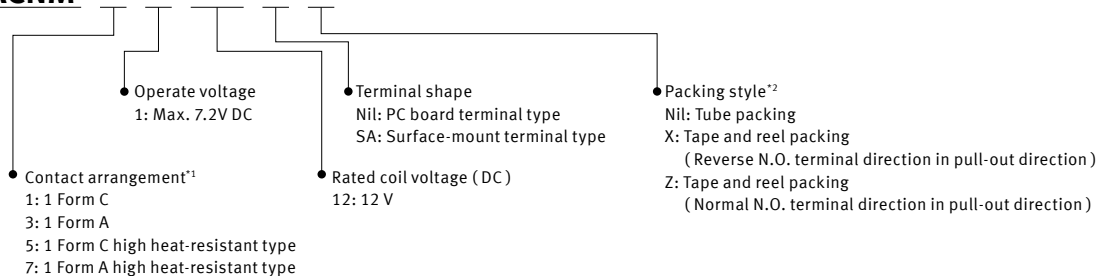

Notes: *1. Surface-mount terminal type is available in high heat-resistant type only.

*2. Tube packing: PC board terminal type only
Tape and reel packing: Surface-mount type only

TYPES

■ PC board terminal type

Contact arrangement	Rated coil voltage	Part No.		Packing	
		Standard type	High heat-resistant type	Carton (1-tube)	Case
1 Form A	12 V DC	ACNM3112	ACNM7112	50 pcs.	1,500 pcs.
1 Form C		ACNM1112	ACNM5112		

Automotive Relays CN-M RELAYS

■ Surface mount terminal type

Contact arrangement	Rated coil voltage	Part No.	Packing	
		High heat resistant type	Carton (1-reel)	Case
1 Form A	12 V DC	ACNM7112SAX	200 pcs.	600 pcs.
		ACNM7112SAZ		
1 Form C		ACNM5112SAX		
ACNM5112SAZ				

Notes: 1. Surface mount terminal type is available in high heat resistant type only.

2. An "X" at the end of the part number indicates, for tape and reel packing, reverse N.O. terminal direction in pull-out direction.

A "Z" at the end of the part number indicates, for tape and reel packing, normal N.O. terminal direction in pull-out direction.

The packing style symbol "X" or "Z" are not marked on the relay.

RATING

■ Coil data

Rated coil voltage	Operate voltage (at 20°C) (initial)	Release voltage (at 20°C) (initial)	Rated operating current [±10%] (at 20°C)	Coil resistance [±10%] (at 20°C)	Rated operating power (at 20°C)	Usable voltage range
12 V DC	Max. 7.2 V DC	Min. 1.0 V DC	53.3 mA	225 Ω	640 mW	10 to 16 V DC

■ Specifications

Item	Specifications	
Contact data	Contact arrangement	1 Form A, 1 Form C
	Contact resistance (initial)	Max. 30 mΩ (typ. 5 mΩ) (By voltage drop 1 A 6 V DC)
	Contact voltage drop (initial)	N.O. side: Max. 0.5 V (at 30 A 12 V DC) N.C. side: Max. 0.5 V (at 15 A 12 V DC)
	Contact material	Ag alloy
	Rated switching capacity (resistive)	N.O. side: 30 A 14 V DC, N.C. side: 15 A 14 V DC
	Max. carrying current*1	N.O. side: 30 A/1 hour, 40 A/2 min (coil applied voltage 16 V DC, at 20°C) 25 A/1 hour, 35 A/2 min (coil applied voltage 16 V DC, at 85°C) 20 A/1 hour, 30 A/2 min (coil applied voltage 16 V DC, at 110°C) (High heat-resistant type)
	Min. switching load (resistive)*2	1 A 14 V DC (at 20°C)
Insulated resistance (initial)	Min. 100 MΩ (at 500 V DC, Measurement at same location as "Dielectric strength" section.)	
Dielectric strength (initial)	Between open contacts	500 Vrms for 1 min (Detection current: 10 mA)
	Between contacts and coil	500 Vrms for 1 min (Detection current: 10 mA)
Time characteristics (initial)	Operate time (at rated voltage)	Max. 10 ms (at 20°C, without contact bounce time)
	Release time (at rated voltage)	Max. 10 ms (at 20°C, without contact bounce time) (without diode)
Shock resistance	Functional	Min. 100 m/s ² (Half-wave pulse of sine wave: 11 ms detection time: 10 μs)
	Destructive	Min. 1,000 m/s ² (Half-wave pulse of sine wave: 6 ms)
Vibration resistance	Functional	10 to 100 Hz, Min. 44.1 m/s ² (Detection time: 10 μs)
	Destructive	10 to 500 Hz, Min. 44.1 m/s ² Time of vibration for each direction; X, Y direction: 2 hours, Z direction: 4 hours
Expected life	Mechanical	Min. 10 x 10 ⁶ (at 120 times/min)
	Electrical	<Resistive load> Min. 10 ⁵ at rated switching capacity operating frequency: 1 s ON, 9 s OFF <Motor load> Min. 2 x 10 ⁵ (motor free) at 80 A (inrush), 16 A (steady), 14 V DC operating frequency: 2 s ON, 6 s OFF <Lamp load> Min. 10 ⁵ at 84 A (inrush), 12 A (steady), 14 V DC operating frequency: 1 s ON, 14 s OFF
Conditions	Conditions for usage, transport and storage*3 Standard type; Ambient temperature: -40 to +85°C, Humidity: 5 to 85% RH High heat resistant type; Ambient temperature: -40 to +110°C, Humidity: 2 to 85% RH (Avoid icing and condensation)	
Weight	Approx. 5.5 g	

Notes: *1. Depends on connection conditions. Also, this does not guarantee repeated switching. We recommend that you confirm operation under actual conditions.

*2. This value can change due to the switching frequency, environmental conditions, and desired reliability level, therefore it is recommended to check this with the actual load.

*3. The upper operation ambient temperature limit is the maximum temperature that can satisfy the coil temperature rise value. For details, please refer to the "Automotive Relay Users Guide".

Please inquire our sales representative if you will be using the relay in a high temperature atmosphere (110°C).

REFERENCE DATA

1-1. Coil temperature rise (at room temperature)

Sample: ACNM1112, 3 pcs
 Measured portion: Inside the coil
 Carrying current: 10 A, 20 A, 30 A
 Ambient temperature: 26°C

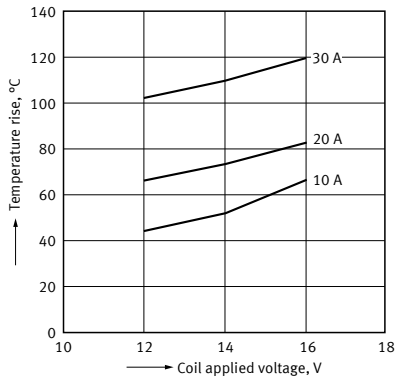

1-2. Coil temperature rise (at 110°C)

Sample: ACNM7112, 3 pcs
 Measured portion: Inside the coil
 Carrying current: 10 A, 20 A
 Ambient temperature: 110°C

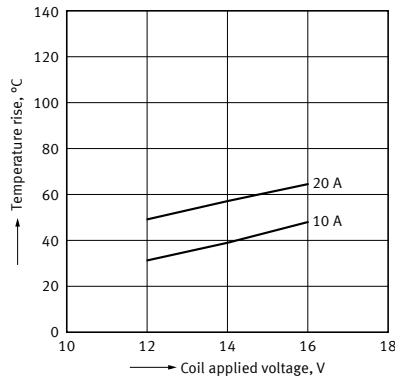

2. Ambient temperature and usable voltage range

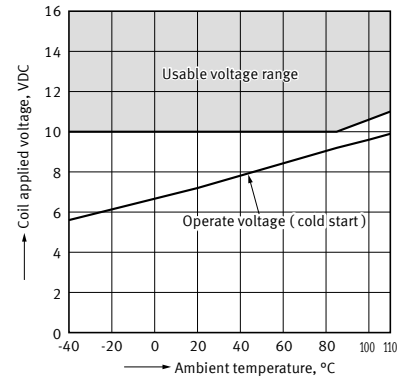

3. Distribution of operate and release voltage 4. Distribution of operate and release time

Sample: ACNM1112, 20 pcs.

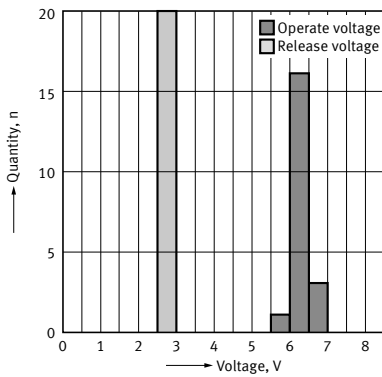

Sample: ACNM1112, 20 pcs.

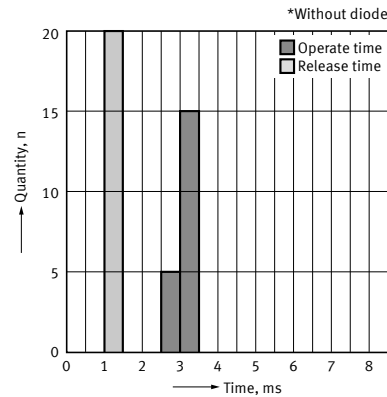

5-1. Electrical life test (Resistive load)

Sample: ACNM1112, 3 pcs.
 Load: Resistive load (N.O. side: 30 A 14 V DC)
 Operating frequency: ON 1 s, OFF 9 s
 Ambient temperature: Room temperature

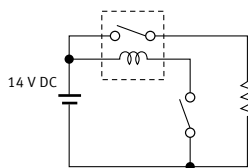

Change of operate and release voltage

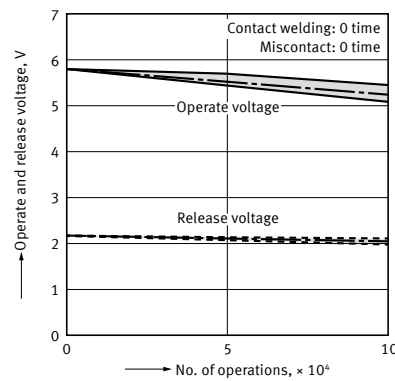

Change of contact resistance

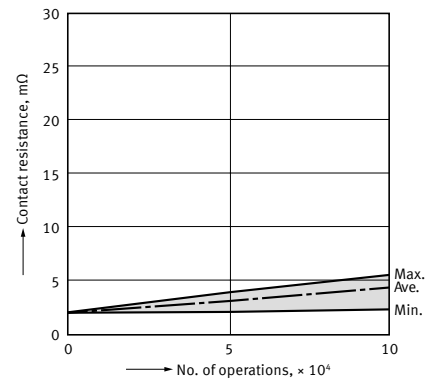

Automotive Relays CN-M RELAYS

5-2. Electrical life test (Motor load)

Sample: ACNM7112, 3 pcs.
 Load: inrush: 80 A / steady: 16 A (motor free)
 Operating frequency: ON 2 s, OFF 6 s
 Ambient temperature: 110°C

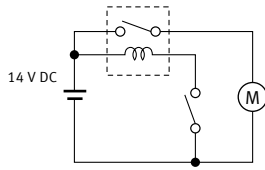

Change of operate and release voltage

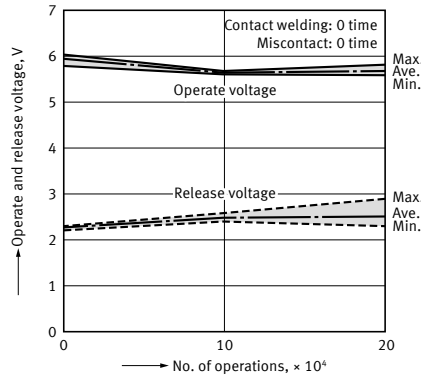

Change of contact resistance

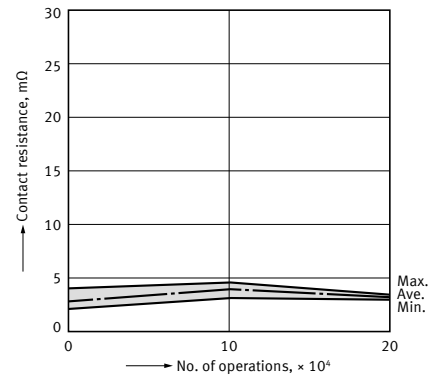

5-3. Electrical life test (Lamp load)

Sample: ACNM3112, 3 pcs.
 Load: inrush: 84 A / steady: 12 A
 Operating frequency: ON 1 s, OFF 14 s
 Ambient temperature: Room temperature

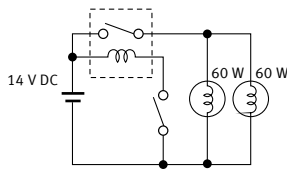

Change of operate and release voltage

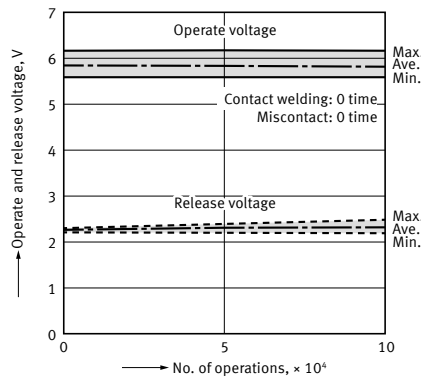

Change of contact resistance

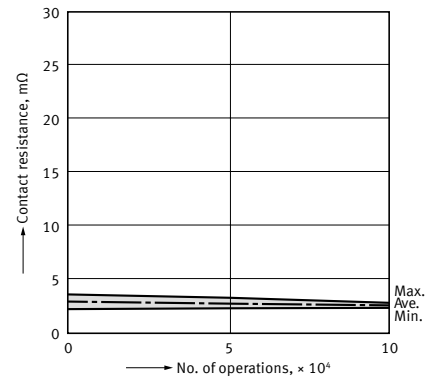

DIMENSIONS

CAD The CAD data of the products with a "CAD" mark can be downloaded from our Website.

Unit: mm

PC board terminal type

CAD

External dimensions

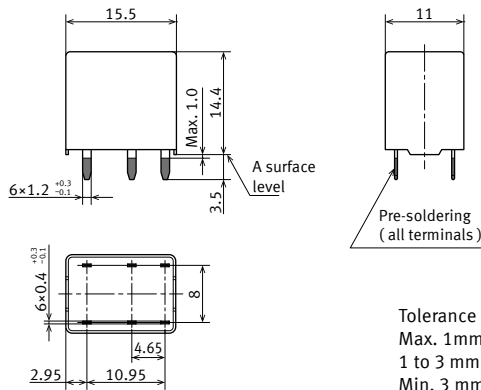

* Dimensions (thickness and width) of terminal is measured before pre-soldering. Intervals between terminals is measured at A surface level.

Tolerance
 Max. 1mm : ±0.1
 1 to 3 mm : ±0.2
 Min. 3 mm : ±0.3

PC board pattern (BOTTOM VIEW)

1 Form A

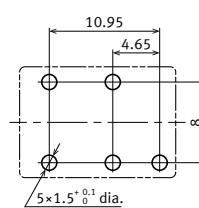

Tolerance: ± 0.1

1 Form C

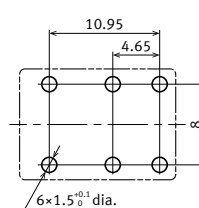

Tolerance: ± 0.1

Schematic (BOTTOM VIEW)

1 Form A

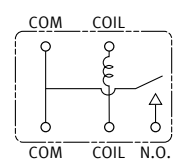

1 Form C

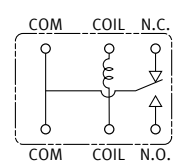

■ Surface mount terminal type

CAD



External dimensions

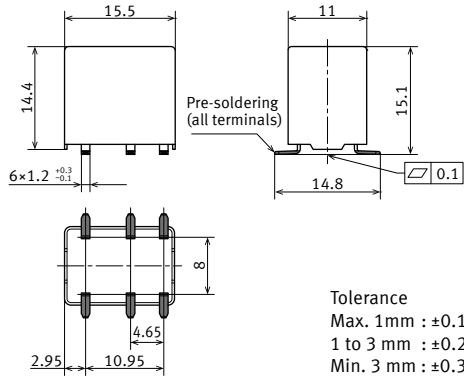

Recommended mounting pad

(TOP VIEW)
1 Form A

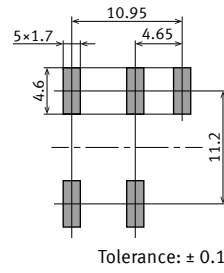

Schematic
(TOP VIEW)
1 Form A

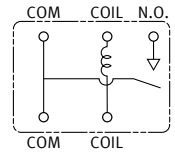

1 Form C

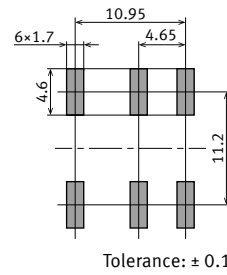

1 Form C

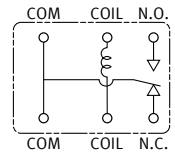

GUIDELINES FOR USAGE

■ For general cautions for use, please refer to the "Automotive Relay Users Guide".

■ Precautions when using CN-M relays

● Usage, transport and storage conditions

1) Ambient temperature, humidity, and air pressure during usage, transport of the relay

- (1) Temperature: -40 to +85°C (standard type)
-40 to +110°C (high heat-resistant type)
- (2) Humidity: 5 to 85% RH (standard type)
2 to 85% RH (high heat-resistant type)
(Avoid icing and condensation)

(3) Air pressure: 86 to 106 kPa

The humidity range varies with the temperature. Use within the range indicated in the graph.

[Temperature and humidity range for usage, transport, and storage]

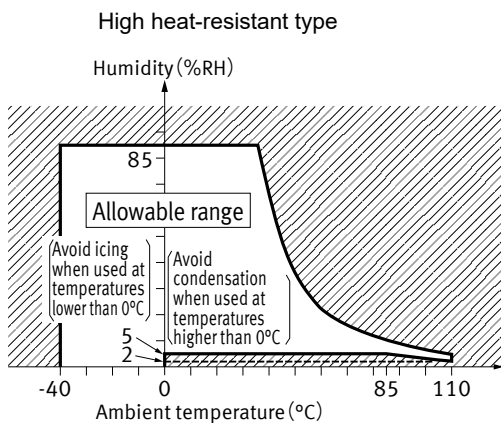
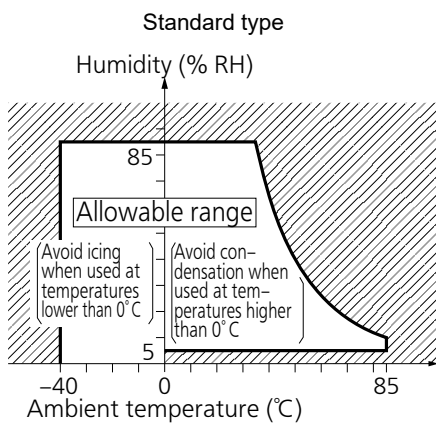

● Storage condition after opening a moisture-prevention package

- (1) After opening a moisture-prevention package, use the item as soon as possible (within 3 days under an environment of Max. 30°C, Max. 70% RH).
- (2) If products are not used within 3 days after opening a moisture-prevention package, store them in a humidity controlled desiccator or in a storage bag with silica gel.

● Mounting and cleaning conditions for surface-mount terminal type relays

When soldering this relay, the following conditions should be observed.

(Recommended condition; Number of reflow: 1 time, Measurement location: terminal temperature)

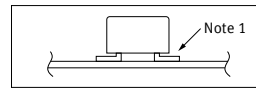
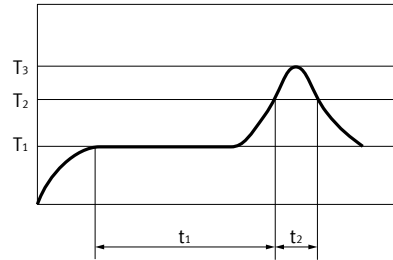

Temperature profile indicates the temperature of the soldered part (Note 1) of terminals on the surface of the PC board, however, for other areas such as the surface of relay case, make a setting so that you do not exceed the recommended conditions.

* The temperature of the relay exterior and interior may be extremely high depending on the component density on the board, the heating method of the reflow oven or circuit board type.

● Other cautions of reflow soldering

- (1) Reflow performance may be affected if you carry out soldering in a way that exceeds the recommended conditions. If you need to exceed the recommended conditions when soldering, please inquire our sales representative before using in an application.
- (2) Please confirm the heat stress of relay by using actual board because it may be changed by board condition or manufacturing process condition.
- (3) Solder creepage, wettability, or soldering strength will be affected by the changing of soldering condition or used solder type. Please check them under the actual production condition in detail.
- (4) Avoid cleaning (ultrasonic cleaning, boiling cleaning, etc.) and coating in order to prevent negative impacts on relay characteristics.

Please refer to "the latest product specifications" when designing your product.

•Requests to customers:

<https://industrial.panasonic.com/ac/e/salespolicies/>

Please contact

Panasonic Corporation

Electromechanical Control Business Division

■1006, Oaza Kadoma, Kadoma-shi, Osaka 571-8506, Japan
industrial.panasonic.com/ac/e/

Panasonic[®]

©Panasonic Corporation 2021