

# APPROVAL SHEET



**WLQC Series**  
**SMD Square Air Wound Coil Inductors**

\*Contents in this sheet are subject to change without prior notice.

## FEATURES

1. Excellence Q and SRF characteristics for RF application.
2. Wide range inductance and various tolerance options.
3. RoHS compliant

## APPLICATIONS

1. Communication system front-end circuit: GSM/3G/LTE, Wi-Fi, GPS.
2. Cabel/Terrestrial/BS Tuner, Bluetooth, Wireless Audio, Remote control.
3. M2M: ZigBee, Proprietary wilreless.
4. EMI solusion in high frequency circuits.

## Shape and Dimension

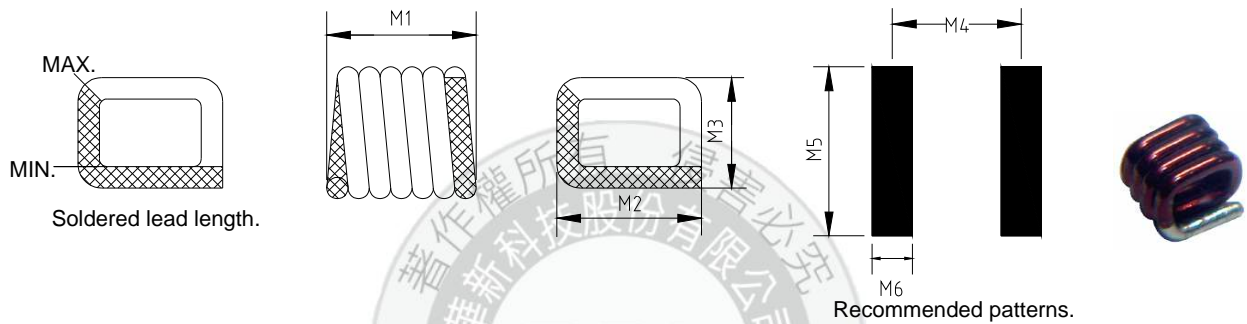

Unit: mm

<b>WLQC0806 Series</b>	<b>M1</b>	<b>M2</b>	<b>M3</b>	<b>M4</b>	<b>M5</b>	<b>M6</b>
WLQC0806Z0□5N5PB	1.346±0.102	1.829±0.254	1.397±0.102	0.962	2.6	0.51
WLQC0806Z0□6N0PB	1.295±0.102	1.829±0.254	1.397±0.102	1.020	2.6	0.51
WLQC0806Z0□8N9PB	1.626±0.152	1.829±0.254	1.397±0.102	1.320	2.6	0.51
WLQC0806Z0□12NPB	1.930±0.152	1.829±0.254	1.397±0.102	1.630	2.6	0.51
WLQC0806Z0□16NPB	2.286±0.152	1.829±0.254	1.397±0.102	1.960	2.6	0.51
WLQC0806Z0□19NPB	2.591±0.152	1.829±0.254	1.397±0.102	2.290	2.6	0.51
<b>WLQC0807 Series</b>	<b>M1</b>	<b>M2</b>	<b>M3</b>	<b>M4</b>	<b>M5</b>	<b>M6</b>
WLQC0807Z0□6N9PB	1.295±0.102	1.829±0.254	1.524±0.254	1.02	2.6	0.51
WLQC0807Z0□10NPB	1.626±0.102	1.829±0.254	1.524±0.254	1.32	2.6	0.51
WLQC0807Z0□11NPB	1.549±0.152	1.829±0.254	1.524±0.254	1.24	2.6	0.51
WLQC0807Z0□14NPB	1.930±0.152	1.829±0.254	1.524±0.254	1.63	2.6	0.51
WLQC0807Z0□17NPB	2.286±0.152	1.829±0.254	1.524±0.254	1.96	2.6	0.51
WLQC0807Z0□22NPB	2.591±0.152	1.829±0.254	1.524±0.254	2.29	2.6	0.51

WLQC0908 Series	M1	M2	M3	M4	M5	M6
WLQC0908Z0□8N1PB	1.473±0.152	2.134±0.152	1.829±0.152	1.12	2.8	0.64
WLQC0908Z0□12NPB	1.854±0.152	2.134±0.152	1.829±0.152	1.45	2.8	0.64
WLQC0908Z0□15NPB	1.549±0.152	2.134±0.152	1.829±0.152	1.24	2.8	0.64
WLQC0908Z0□17NPB	2.210±0.152	2.134±0.152	1.829±0.152	1.83	2.8	0.64
WLQC0908Z0□22NPB	2.565±0.152	2.134±0.152	1.829±0.152	2.18	2.8	0.64
WLQC0908Z0□23NPB	2.235±0.152	2.134±0.152	1.829±0.152	1.90	2.8	0.64
WLQC0908Z0□25NPB	2.972±0.152	2.134±0.152	1.829±0.152	2.57	2.8	0.64
WLQC0908Z0□27NPB	2.972±0.152	2.134±0.152	1.829±0.152	2.57	2.8	0.64

### Ordering Information

WL	QC	0806	Z0	J	5N5	P	B
<b>Product Code</b>	<b>Series</b>	<b>Dimensions</b>	<b>Series extension</b>	<b>Tolerance</b>	<b>Value</b>	<b>Packing Code</b>	
WL: Inductor	Square air wound coil inductor.	0806 0807 0908	Z0:STD	G: ± 2% J: ± 5%	5N5 =5.5nH 17N=17nH	P=7" Reeled (Embossed Tape)	B:STD

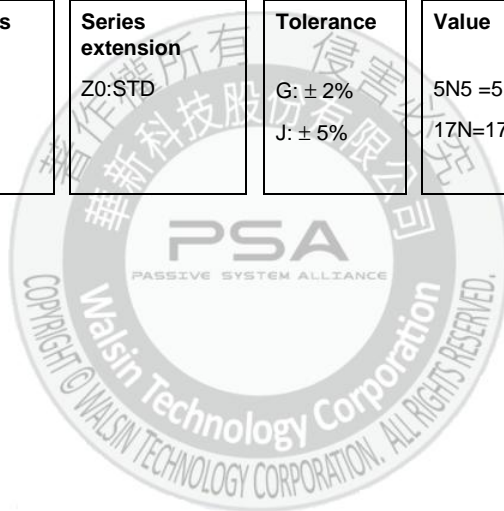

## Electrical Characteristics

WLQC0806 Series	Turns	Tolerance	L (nH)	Q (min)	Test Freq (MHz)	DCR (mΩ)Max	SRF (GHz)Typ	Rated Current (A) Max
WLQC0806Z0□5N5PB	3	G、J	5.5	60	400	3.4	4.9	2.9
WLQC0806Z0□6N0PB	3	G、J	6.0	64	400	6.0	5.2	2.9
WLQC0806Z0□8N9PB	4	G、J	8.9	90	400	7.0	4.3	2.9
WLQC0806Z0□12NPB	5	G、J	12.3	90	400	8.0	4.8	2.9
WLQC0806Z0□16NPB	6	G、J	15.7	90	400	9.0	4.4	2.9
WLQC0806Z0□19NPB	7	G、J	19.4	90	400	10.0	4.0	2.9
WLQC0807 Series	Turns	Tolerance	L (nH)	Q (min)	Test Freq (MHz)	DCR (mΩ)Max	SRF (GHz)Typ	Rated Current (A) Max
WLQC0807Z0□6N9PB	3	G、J	6.9	100	400	6.0	4.6	2.7
WLQC0807Z0□10NPB	4	G、J	10.2	100	400	7.0	4.0	2.7
WLQC0807Z0□11NPB	4	G、J	11.2	90	400	6.3	3.6	2.7
WLQC0807Z0□14NPB	5	G、J	13.7	100	400	8.0	4.3	2.7
WLQC0807Z0□17NPB	6	G、J	17.0	100	400	9.0	4.0	2.7
WLQC0807Z0□22NPB	7	G、J	22.0	100	400	10.0	3.5	2.7
WLQC0908 Series	Turns	Tolerance	L (nH)	Q (min)	Test Freq (MHz)	DCR (mΩ)Max	SRF (GHz)Typ	Rated Current (A) Max
WLQC0908Z0□8N1PB	3	G、J	8.1	130	400	6.0	5.2	4.4
WLQC0908Z0□12NPB	4	G、J	12.1	130	400	7.0	4.3	4.4
WLQC0908Z0□15NPB	4	G、J	14.7	90	400	7.2	3.0	4.4
WLQC0908Z0□17NPB	5	G、J	16.6	130	400	8.0	3.4	4.4
WLQC0908Z0□22NPB	6	G、J	21.5	130	400	9.0	3.7	4.4
WLQC0908Z0□23NPB	6	G、J	23.0	130	400	10.0	2.6	4.4
WLQC0908Z0□25NPB	7	G、J	25.0	130	400	10.0	2.5	4.4
WLQC0908Z0□27NPB	7	G、J	27.3	130	400	10.0	3.2	4.4

1. Tolerance : J:±5%,G:±2%
2. Inductance & Q measured on the HP4291B. With HP16193A test fixture.
3. SRF measured using the HP8753E
4. Operating temperature range: -40°C to +125°C.
5. Storage temperature Component:-40°C to +145°C, Packaging : -40°C. TO +80°C
6. Electrical specifications at 25°C.
7. MSL : LEVEL 1

## Characteristic Curve

WLQC0806

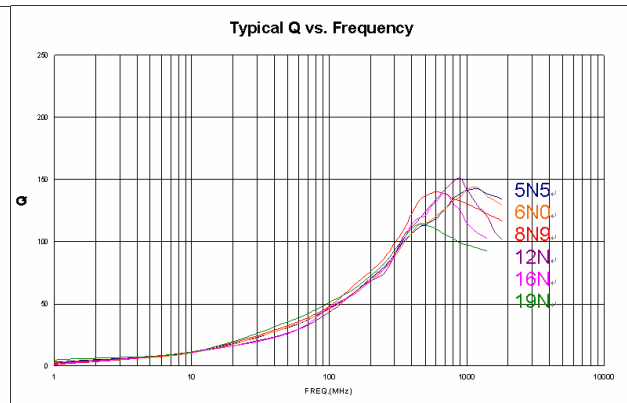
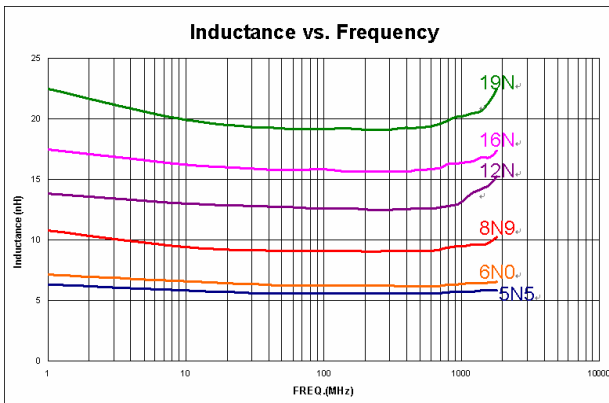

WLQC0807

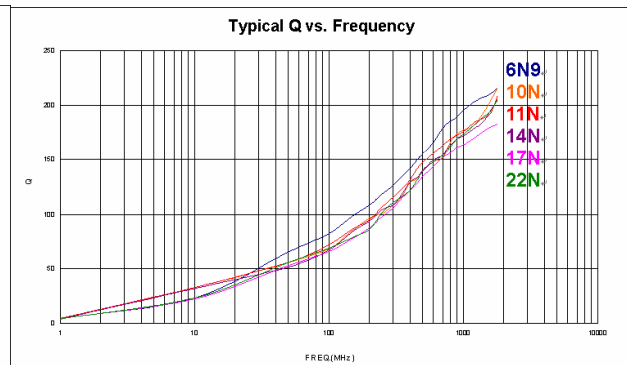
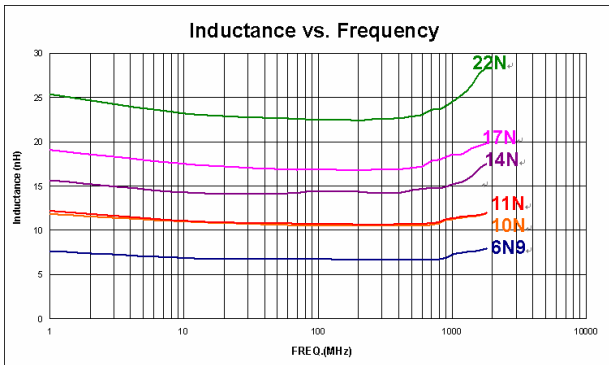

WLQC0908

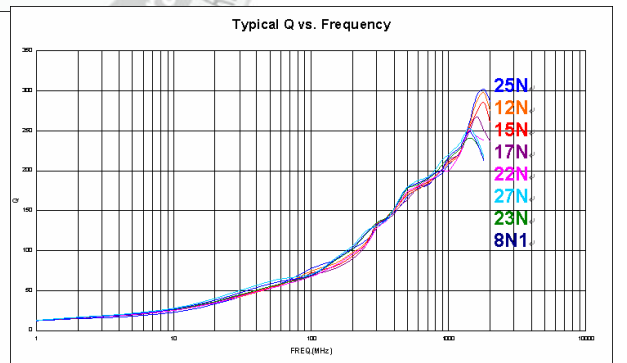
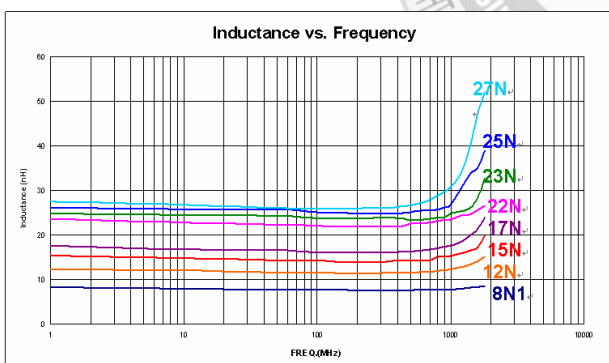

## RELIABILITY PERFORMANCE

### Reliability Experiment For Electrical

Test Item	Test Condition	Standard Source
Humidity Test	+40°C ± 2°C, humidity of 90% ± 5% (total 96 hours).	MIL-STD-202G Method 103B Test Condition B
High Temperature Test	1. Temperature: +125°C ± 2°C 2. Test time: 48 ± 2hrs	IEC 68-2 Test Condition B
Low Temperature Test	1. Temperature: -40°C ± 2°C 2. Test time: 48 ± 2hrs	IEC 68-2 Test Condition A
Thermal Shock	+125°C ± 5°C (30 minutes) ~ -40 ± 5°C (30 minutes), temperature switch time: 5 minutes (total 50 cycles).	MIL-STD-202G Method 107G Test Condition B-2
Life Test	+70°C ± 5°C (250Hours)	MIL-STD-202G Method 108A Test Condition B

### Reliability Experiment For Physical

Test Item	Test Condition	Standard Source
Vibration Test	10-55-10HZ, amplitude: 1.5mm, direction: X, Y, Z axes, each axis 2 hours (total 6 hours).	MIL-STD-202G Method 201A
Solder Heat Resistance Test	IR/convection reflow: Peak Temp 250 ± 5°C for 5Sec in air, Through 2 Cycle. Temperature Ramp: +1~4°C/sec; Above 183°C, must keep 90 s - 120 s	MIL-STD-202G Method 210F Test Condition (Reflow)
Solder Ability Test	Soak in 245 °C solder pot of 3Sec, PAD must have 95% above coverage.	J-STD-003B

## TYPICAL RoHS REFLOW PROFILE

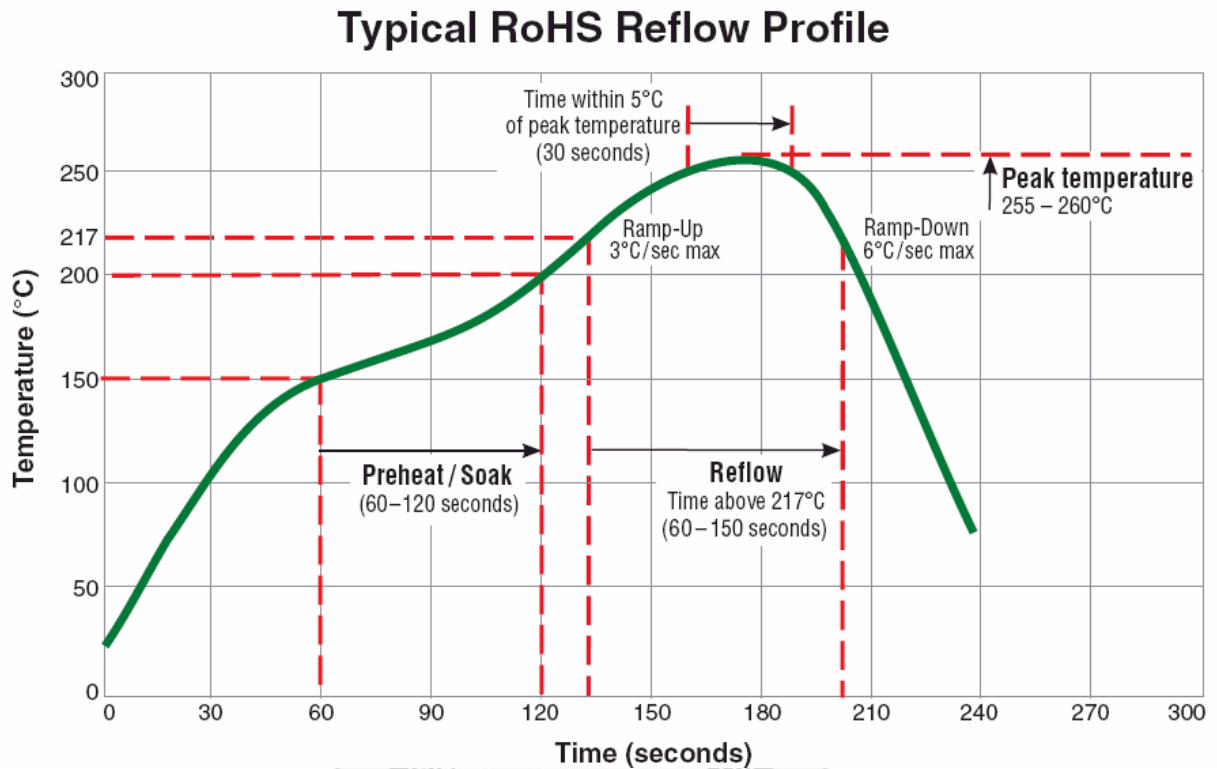

**Packaging Specification**

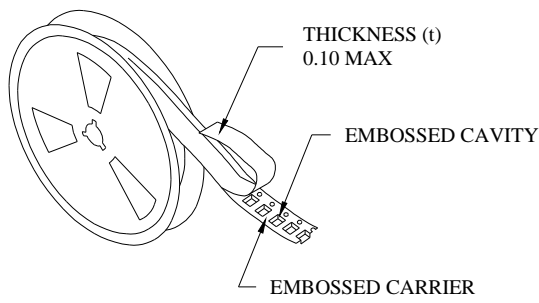

- THE FORCE FOR TEARING OFF COVER TAPE IS 10 TO 130 GRAMS IN THE ARROW DIRECTION.

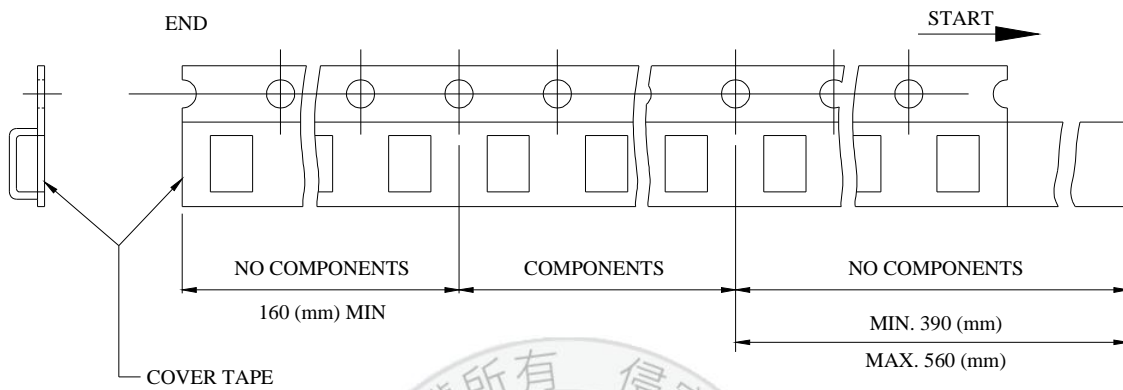
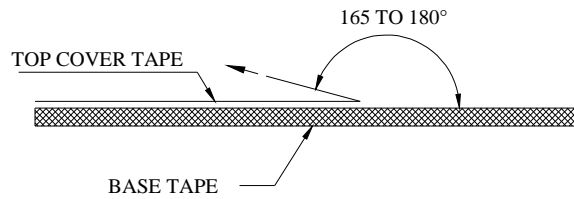

■ CARRIER TAPE REELS (mm)

MATERIAL: PLASTIC

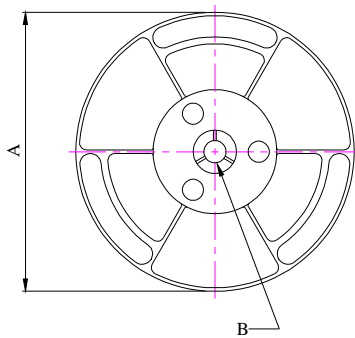

(Unit : mm)

■ DIMENSIONS OF CARRIER TAPE (mm)

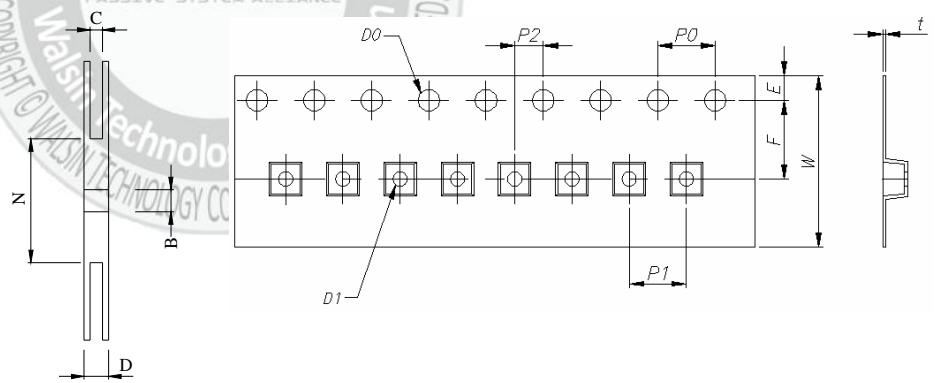



0806	A	B	C	D	N	W	E	F	P1	P2	P0	D0	D1	t
DIM.	178	13.0	12.4	16.8	50	12.0	1.75	5.50	4.00	2.0	4.0	1.5	1.0	0.23
TOL.	±2.0	+0.5 -0.2	+2.0 -0	MAX.	MIN.	±0.2	±0.1	±0.1	±0.10	±0.1	±0.1	+0.1/-0	±0.1	±0.05

0807	A	B	C	D	N	W	E	F	P1	P2	P0	D0	D1	t
DIM.	178	13.0	12.4	16.8	50	12.0	1.75	5.50	4.00	2.0	4.0	1.5	1.0	0.23
TOL.	±2.0	+0.5 -0.2	+2.0 -0	MAX.	MIN.	±0.2	±0.1	±0.1	±0.10	±0.1	±0.1	+0.1/-0	±0.1	±0.05

0908	A	B	C	D	N	W	E	F	P1	P2	P0	D0	D1	t
DIM.	178	13.0	12.4	16.8	50	12.0	1.75	5.50	4.00	2.0	4.0	1.5	1.0	0.25
TOL.	±2.0	+0.5 -0.2	+2.0 -0	MAX.	MIN.	±0.2	±0.1	±0.1	±0.10	±0.1	±0.1	+0.1/-0	±0.1	±0.05

Quantity per reel : 2K pcs

