

SERPAC RB65X06Y24Y 2

Electronic Enclosures

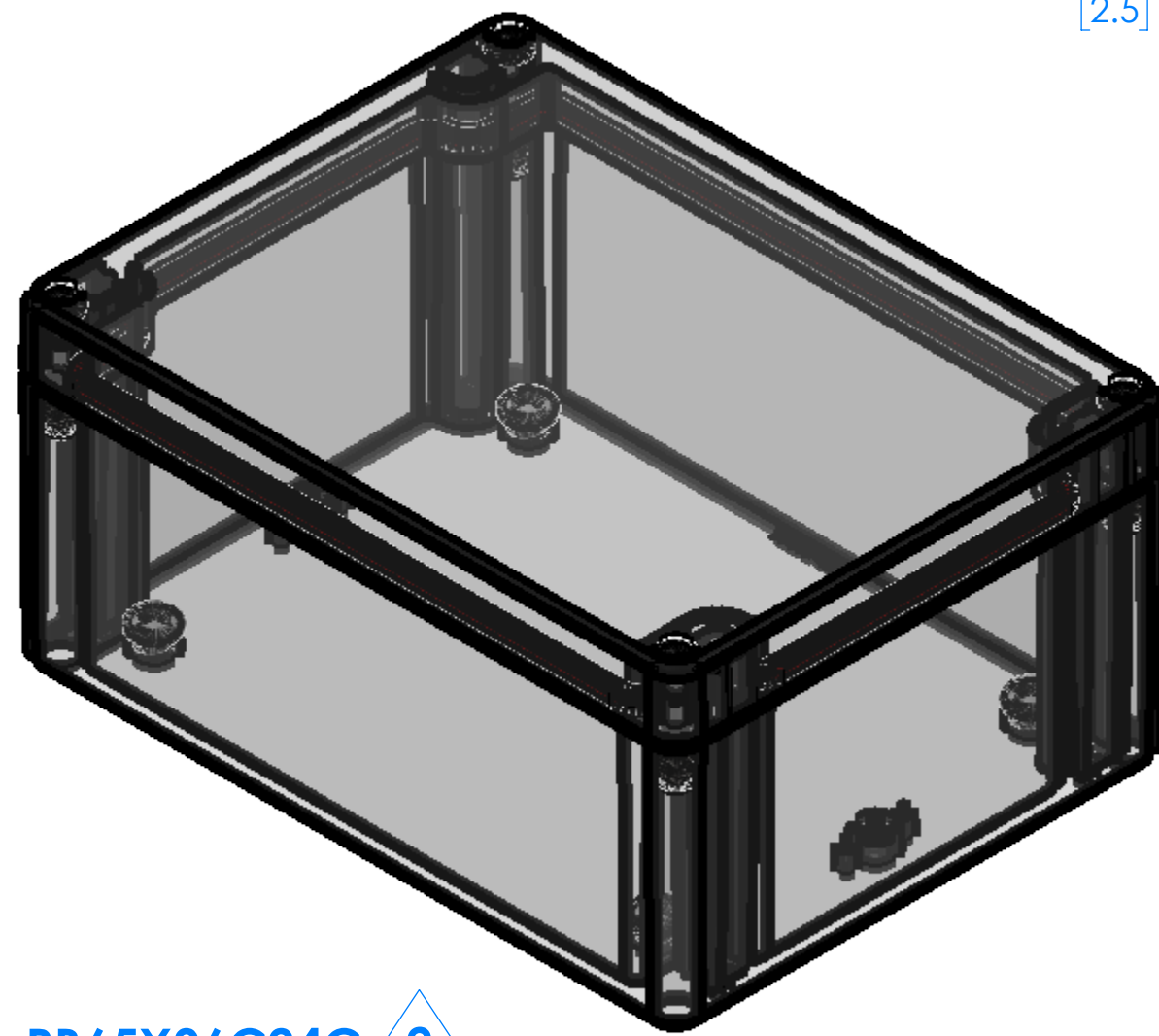

RB65X06C24C 2
(Part shown, no material (X) specified)

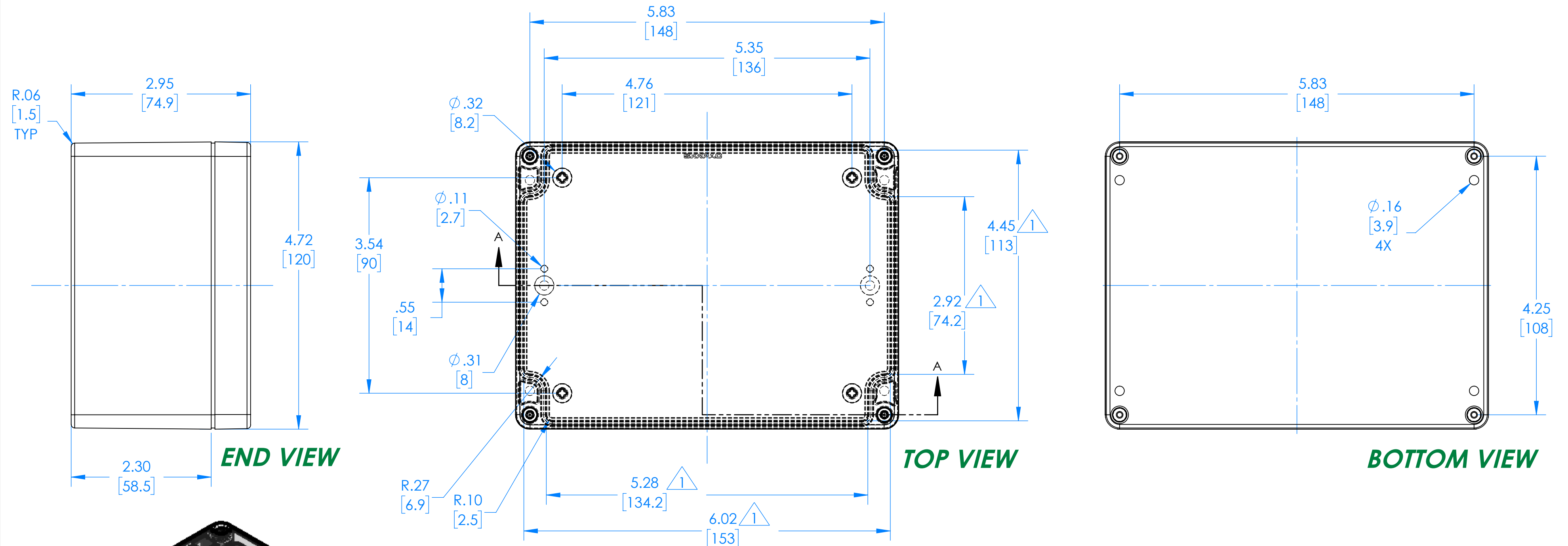
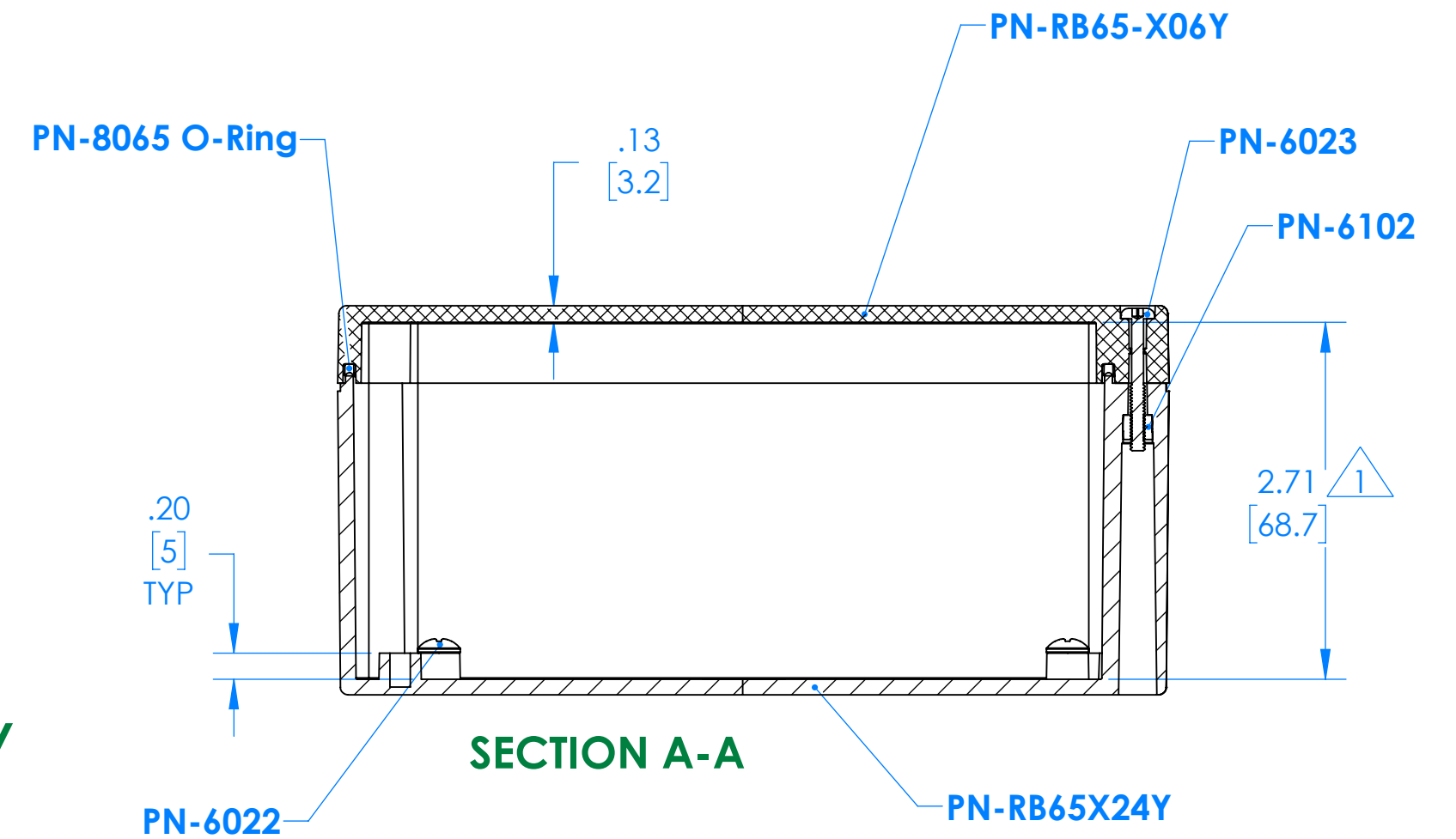
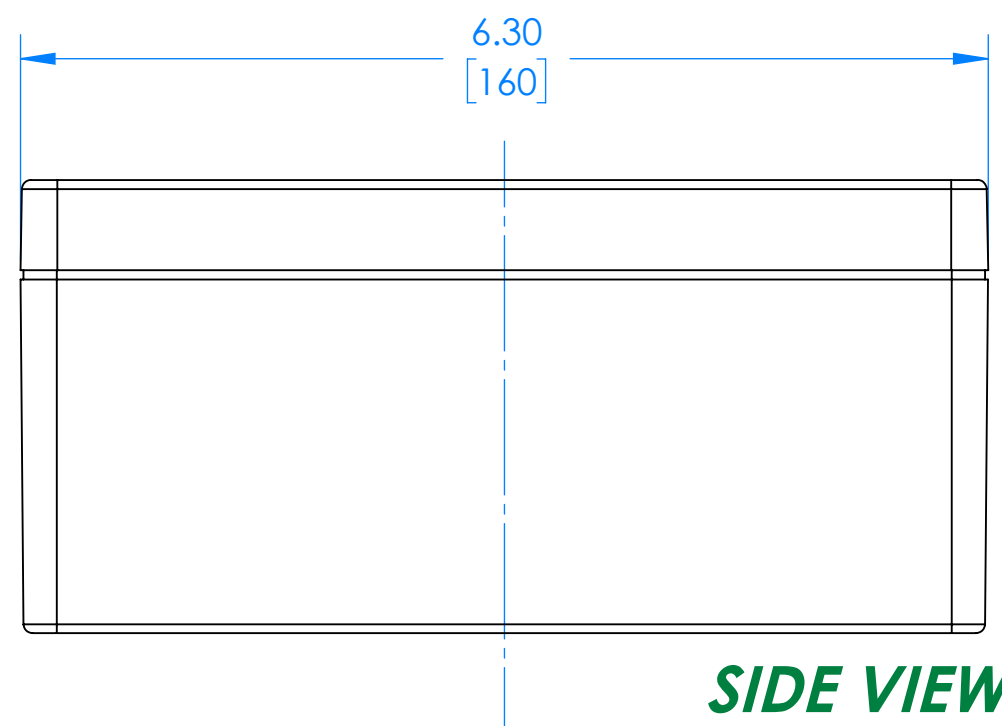

PN	Description
RB65-X06Y	(1) RB65-X06Y Top
RB65X24Y	(1) RB65X24Y Bottom
8065	(1) RB65 O-Ring
6023	(4) #4-40 Torx 10 Hd Screw x 1.00
6022	(4) #10 High/Low Pan Hd x 1/4"
6102	(4) #4-40 Threaded Insert

1 = INTERIOR DIMENSIONS (@ BOTTOM)
2 = STANDARD COLORS (Y) ARE: BLACK (B), CLEAR (C) AND GRAY (G)
 TOPS AND BOTTOMS ALL POSSIBLE COMBINATIONS AVAILABLE
 STANDARD MATERIALS (X) IS: POLYCARBONATE (P)

-Watertight enclosure meets or exceeds Nema 4 and or IP67.

DIMENSIONS in Inch [mm]

RB65 Circuit Board (Fits all Parts starting with RB65)

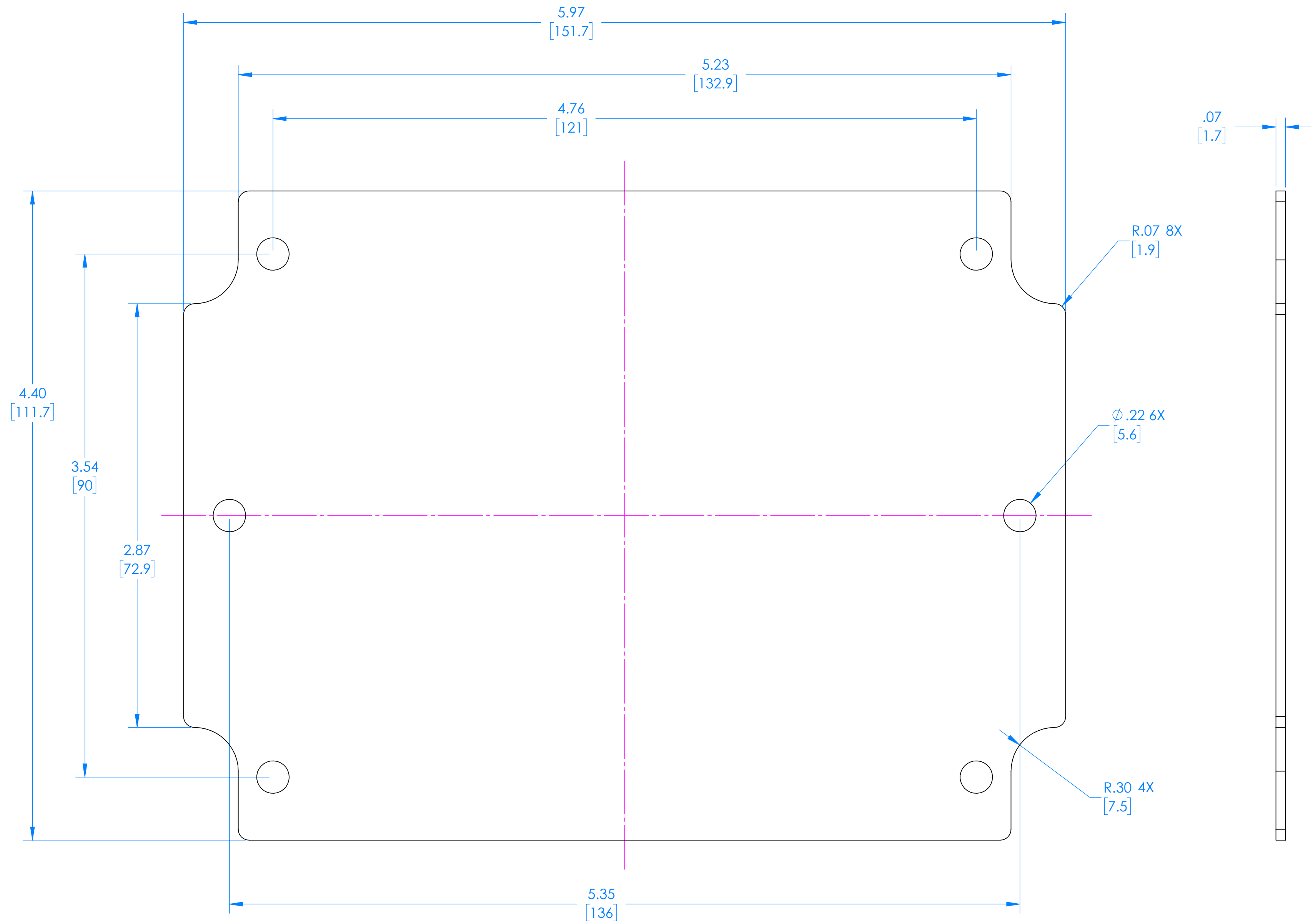

(REFERENCE ONLY)