

# Fast Rectifiers

## ES2A-ES2D



SMB  
CASE 403AF

### Features

- For Surface Mount Applications
- Glass–Passivated Junction
- Low–Profile Package
- Easy Pick and Place
- Built–in Strain Relief
- Superfast Recovery Times for High Efficiency
- These are Pb–Free Devices

### MARKING DIAGRAM

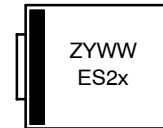

(COLOR BAND DENOTES CATHODE)

Z = Assembly Plant Code  
Y = Year  
WW = Work Week  
ES2x = Specific Device Code  
x = A, B, C, D

### ABSOLUTE MAXIMUM RATINGS (T<sub>A</sub> = 25°C unless otherwise noted)

Symbol	Parameter	Value	Unit
V <sub>RRM</sub>	Maximum Repetitive Reverse Voltage ES2A ES2B ES2C ES2D	50 100 150 200	V
I <sub>F(AV)</sub>	Average Rectified Forward Current, 0.375" Lead Length at T <sub>L</sub> = 115°C	2.0	A
I <sub>FSM</sub>	Non–Repetitive Peak Forward Surge Current, 8.3 ms Single Half–Sine Wave	50	A
T <sub>STG</sub>	Storage Temperature Range	–55 to +150	°C
T <sub>J</sub>	Operating Junction Temperature Range	–55 to +150	°C

Stresses exceeding those listed in the Maximum Ratings table may damage the device. If any of these limits are exceeded, device functionality should not be assumed, damage may occur and reliability may be affected.

### ORDERING INFORMATION

See detailed ordering and shipping information on page 3 of this data sheet.

### THERMAL CHARACTERISTICS (T<sub>A</sub> = 25°C unless otherwise noted)

Symbol	Parameter	Value	Unit
P <sub>D</sub>	Power Dissipation	1.66	W
R <sub>θJA</sub>	Thermal Resistance, Junction to Ambient (Note 1)	75	°C/W
R <sub>θJL</sub>	Thermal Resistance, Junction to Lead (Note 1)	20	°C/W

1. Device mounted on FR–4 PCB 0.013 mm.

### ELECTRICAL CHARACTERISTICS (T<sub>A</sub> = 25°C unless otherwise noted)

Symbol	Parameter	Test Conditions	Value				Unit
			ES2A	ES2B	ES2C	ES2D	
V <sub>F</sub>	Maximum Forward Voltage	I <sub>F</sub> = 2.0 A	0.90				V
t <sub>rr</sub>	Reverse Recovery Time	I <sub>F</sub> = 0.5 A, I <sub>R</sub> = 1.0 A, I <sub>RR</sub> = 0.25 A	20				ns
I <sub>R</sub>	Maximum Reverse Current at Rated V <sub>R</sub>	T <sub>A</sub> = 25°C T <sub>A</sub> = 100°C	10 350				μA
C <sub>T</sub>	Total Capacitance	V <sub>R</sub> = 4.0 V, f = 1.0 MHz	18				pF

Product parametric performance is indicated in the Electrical Characteristics for the listed test conditions, unless otherwise noted. Product performance may not be indicated by the Electrical Characteristics if operated under different conditions.

TYPICAL PERFORMANCE CHARACTERISTICS

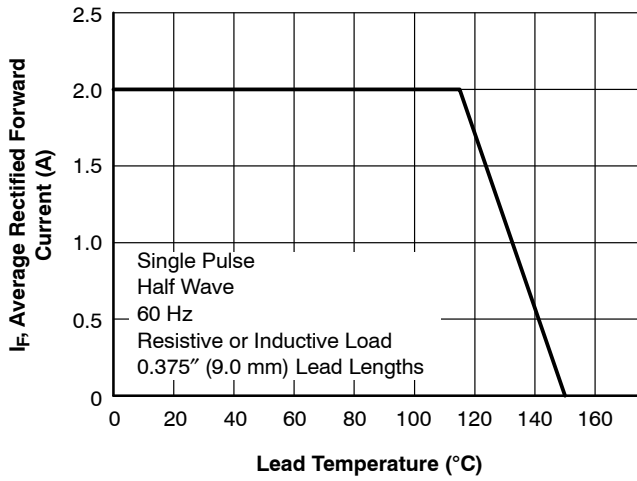

Figure 1. Forward Current Derating Curve

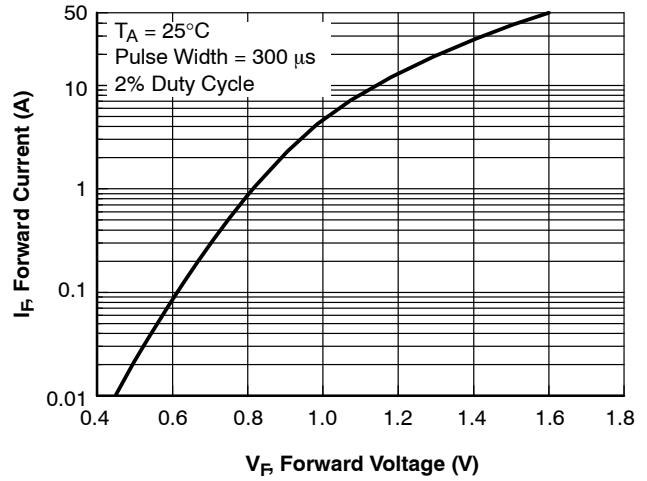

Figure 2. Forward Voltage Characteristics

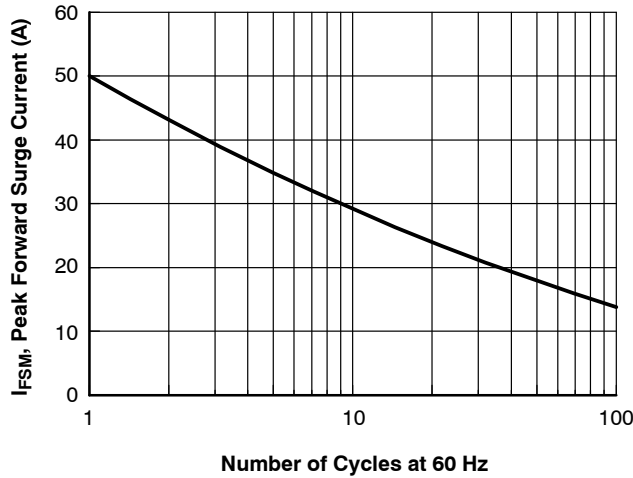

Figure 3. Non-Repetitive Surge Current

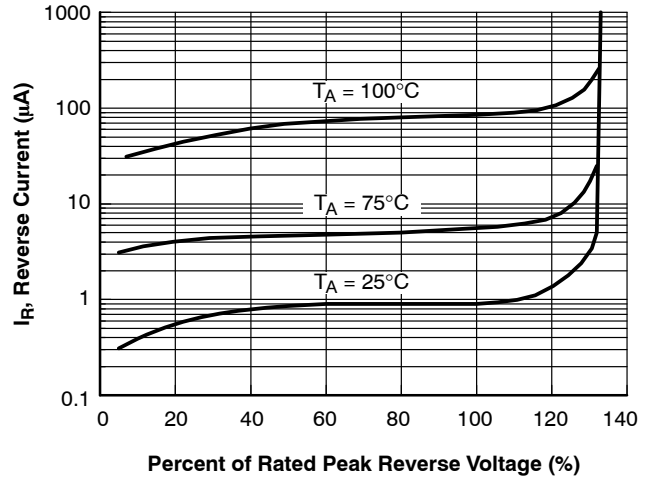

Figure 4. Reverse Current vs. Reverse Voltage

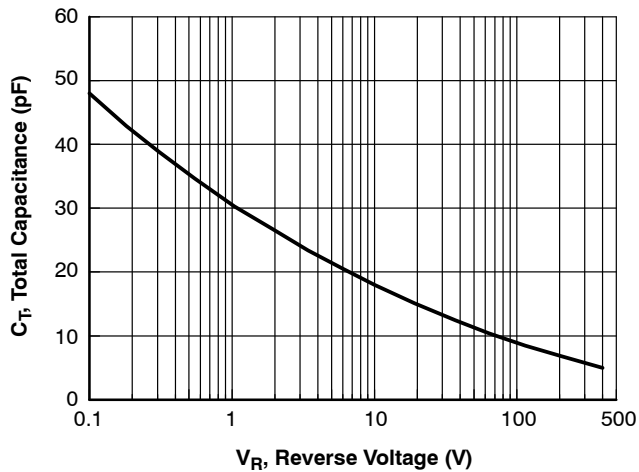
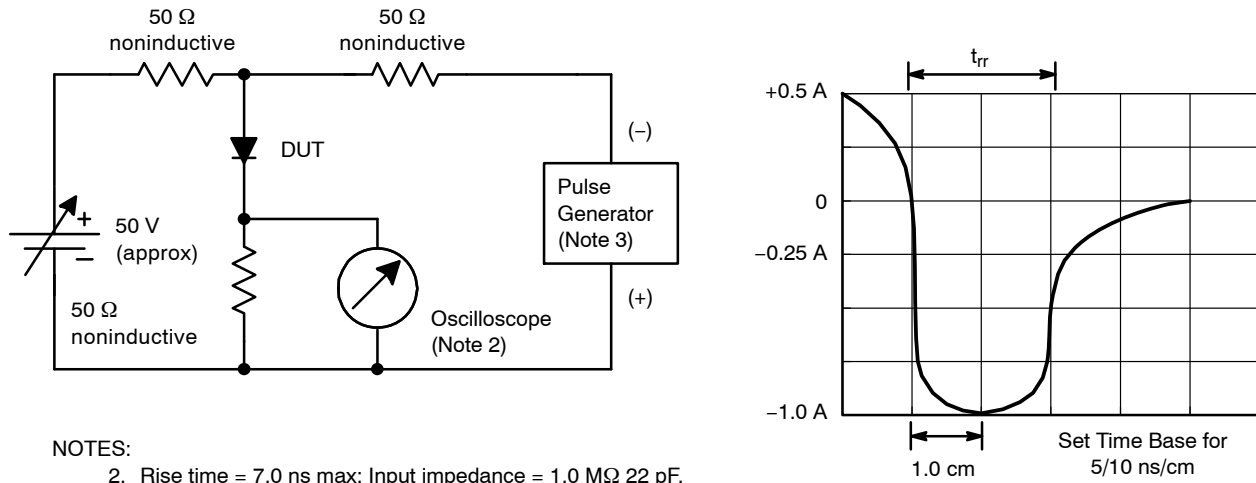

Figure 5. Total Capacitance

## ES2A–ES2D



**Figure 6. Reverse Recovery Time Characteristic and Test Circuit Diagram**

### ORDERING INFORMATION

Part Number	Device Code Marking	Package Type	Shipping†
ES2A	ES2A	SMB (Pb-Free)	3000 / Tape & Reel
ES2B	ES2B	SMB (Pb-Free)	3000 / Tape & Reel
ES2C	ES2C	SMB (Pb-Free)	3000 / Tape & Reel
ES2D	ES2D	SMB (Pb-Free)	3000 / Tape & Reel

†For information on tape and reel specifications, including part orientation and tape sizes, please refer to our Tape and Reel Packaging Specifications Brochure, [BRD8011/D](#).

# MECHANICAL CASE OUTLINE

## PACKAGE DIMENSIONS

ON Semiconductor®



### SMB CASE 403AF ISSUE O

DATE 31 AUG 2016



DETAIL A  
SCALE 20 : 1

#### NOTES:

- A. EXCEPT WHERE NOTED CONFORMS TO JEDEC DO214 VARIATION AA.
- B. DOES NOT COMPLY JEDEC STD. VALUE.
- C. ALL DIMENSIONS ARE IN MILLIMETERS.
- D. DIMENSIONS ARE EXCLUSIVE OF BURRS, MOLD FLASH AND TIE BAR PROTRUSIONS.
- E. DIMENSION AND TOLERANCE AS PER ASME Y14.5-1994.
- F. LAND PATTERN STD. DIOM5336X240M.

<b>DOCUMENT NUMBER:</b>	<b>98AON13441G</b>	Electronic versions are uncontrolled except when accessed directly from the Document Repository. Printed versions are uncontrolled except when stamped "CONTROLLED COPY" in red.
<b>DESCRIPTION:</b>	<b>SMB</b>	<b>PAGE 1 OF 1</b>

ON Semiconductor and are trademarks of Semiconductor Components Industries, LLC dba ON Semiconductor or its subsidiaries in the United States and/or other countries. ON Semiconductor reserves the right to make changes without further notice to any products herein. ON Semiconductor makes no warranty, representation or guarantee regarding the suitability of its products for any particular purpose, nor does ON Semiconductor assume any liability arising out of the application or use of any product or circuit, and specifically disclaims any and all liability, including without limitation special, consequential or incidental damages. ON Semiconductor does not convey any license under its patent rights nor the rights of others.

**onsemi**, **Onsemi**, and other names, marks, and brands are registered and/or common law trademarks of Semiconductor Components Industries, LLC dba "**onsemi**" or its affiliates and/or subsidiaries in the United States and/or other countries. **onsemi** owns the rights to a number of patents, trademarks, copyrights, trade secrets, and other intellectual property. A listing of **onsemi**'s product/patent coverage may be accessed at [www.onsemi.com/site/pdf/Patent-Marking.pdf](http://www.onsemi.com/site/pdf/Patent-Marking.pdf). **onsemi** reserves the right to make changes at any time to any products or information herein, without notice. The information herein is provided "as-is" and **onsemi** makes no warranty, representation or guarantee regarding the accuracy of the information, product features, availability, functionality, or suitability of its products for any particular purpose, nor does **onsemi** assume any liability arising out of the application or use of any product or circuit, and specifically disclaims any and all liability, including without limitation special, consequential or incidental damages. Buyer is responsible for its products and applications using **onsemi** products, including compliance with all laws, regulations and safety requirements or standards, regardless of any support or applications information provided by **onsemi**. "Typical" parameters which may be provided in **onsemi** data sheets and/or specifications can and do vary in different applications and actual performance may vary over time. All operating parameters, including "Typicals" must be validated for each customer application by customer's technical experts. **onsemi** does not convey any license under any of its intellectual property rights nor the rights of others. **onsemi** products are not designed, intended, or authorized for use as a critical component in life support systems or any FDA Class 3 medical devices or medical devices with a same or similar classification in a foreign jurisdiction or any devices intended for implantation in the human body. Should Buyer purchase or use **onsemi** products for any such unintended or unauthorized application, Buyer shall indemnify and hold **onsemi** and its officers, employees, subsidiaries, affiliates, and distributors harmless against all claims, costs, damages, and expenses, and reasonable attorney fees arising out of, directly or indirectly, any claim of personal injury or death associated with such unintended or unauthorized use, even if such claim alleges that **onsemi** was negligent regarding the design or manufacture of the part. **onsemi** is an Equal Opportunity/Affirmative Action Employer. This literature is subject to all applicable copyright laws and is not for resale in any manner.

## PUBLICATION ORDERING INFORMATION

### LITERATURE FULFILLMENT:

Email Requests to: [orderlit@onsemi.com](mailto:orderlit@onsemi.com)

**onsemi Website:** [www.onsemi.com](http://www.onsemi.com)

### TECHNICAL SUPPORT

**North American Technical Support:**

Voice Mail: 1 800-282-9855 Toll Free USA/Canada

Phone: 011 421 33 790 2910

**Europe, Middle East and Africa Technical Support:**

Phone: 00421 33 790 2910

For additional information, please contact your local Sales Representative