

General Description

The MAX2839AS evaluation kit (EV kit) simplifies testing of the MAX2839AS receive and transmit performance in WiMAX™ applications operating in the 2.3GHz to 2.7GHz band. The EV kit provides 50Ω SMA connectors for all RF and baseband inputs and outputs. Differential to single-ended and single-ended to differential line drivers are provided to convert the differential I/Q baseband inputs and outputs to single ended.

Component List

DESIGNATION	QTY	DESCRIPTION
+5V, -5V, VBAT, VCCAUX	4	Test points, PCB red Keystone 5010
B0–B7, CSB, DIN, DOUT, ENABLE, LOAD, PABIAS, RSSI, RXBBIA+, RXBBIA-, RXBBIB+, RXBBIB-, RXBBQA+, RXBBQA-, RXBBQB+, RXBBQB-, RXHP, SCLK, TPCLKOUT, TUNEM, TUNEP, TXBBI+, TXBBI-, TXBBQ+, TXBBQ-, TXRX, VCM	34	Test points, PCB mini-red Keystone 5000
CLKOUT, FREF, RXBBIA, RXBBIB, RXBBQA, RXBBQB, RXINA, RXINB, TXBBI, TXBBQ, TXRF	11	SMA edge-mount connectors, round Johnson 142-0701-801
C1, C3, C8, C21, C22, C24, C30, C36, C38, C41, C42, C44, C49, C76	0	Open, ±10%, 0402 capacitors Leave site open
C2, C15	2	2.2pF ±0.1pF, 0402 capacitors Murata GRM1555C1H2R2B
C4–C7, C10, C13, C17, C18, C35, C40, C43, C45–C48, C50, C51, C52, C59, C60, C67	21	0.1µF ±10%, 0402 capacitors Murata GRM155R61C104K
C9, C16, C19, C70, C89	5	22pF ±5%, 0402 capacitors Murata GRM1555C1H220J

Features

- On-Board Line Drivers and Voltage References
- 50Ω SMA Connectors on All RF and Baseband Ports

Ordering Information

PART	TYPE
MAX2839ASEVKIT+	EV Kit

+Denotes lead(Pb)-free and RoHS compliant.

DESIGNATION	QTY	DESCRIPTION
C11, C23, C26, C32, C74, C75, C87, C88	8	0.01µF ±10%, 0402 capacitors Murata GRM155R71C103K
C12, C53, C55, C66	4	10µF ±10%, 0805 capacitors Murata GRM21BR61A106K
C14	1	2200pF ±10%, 0402 capacitor Murata GRM155R71H222K
C25, C77	2	1000pF ±10%, 0402 capacitors Murata GRM155R71H102K
C27	1	2.2µF ±10%, 0805 capacitor Murata GRM21BR71A225K
C29, C86	2	1.0µF ±10%, 0402 capacitors Murata GRM155R60J105K
C33	1	100pF ±5%, 0402 capacitor Murata GRM155C1H101J
C37, C39	2	2.2µF ±10%, 0603 capacitors Murata GRM188R61A225K
C54, C56	2	1.8pF ±0.1pF, 0402 capacitors Murata GRM1555C1H1R8B
C68, C69	2	4.3pF ±0.1pF, 0402 capacitors Murata GRM1555C1H4R3B
C79	1	120pF ±5%, 0402 capacitor Murata GRM1555C1H121J
GND1, GND2	2	Test points, PCB black Keystone 5011
J17	0	Not installed, 2 x 13-pin header
J18	1	DB25 horizontal male PCB connector AMP 5747238-4

WiMAX is a trademark of WiMAX Forum.

Component List (continued)

DESIGNATION	QTY	DESCRIPTION
JPB0–JPB7, JPENABLE, JPLOAD, JPRXHP, JPTXRX, RXBBBUF1, RXBBBUF2, VBAT_LDO, SYNTH_LDO	16	1 x 3-pin headers Sullins PEC36SAAN
JPCSB, JPDIN, JPDOOUT, JPCLK	0	Not installed, 1 x 3-pin headers
L1, L6, L13–L16	0	Do not install, ±0%, 0402 inductors Murata LQP15MN2N7B02
L2, L4, L5, L7, L9, L10	0	Not installed, inductors
L3, L8	2	3.6nH ±0.1nH, 0402 inductors Murata LQP15MN3N6B02
R1, R7	2	200Ω ±1%, 0402 resistors*
R2, R5, R6, R38	4	205Ω ±1%, 0402 resistors*
R3, R10	2	226Ω ±1%, 0402 resistors*
R4, R26, R40, R57	4	49.9Ω ±1%, 0402 resistors*
R8, R11, R12, R14–R19, R24, R25, R28, R30, R31, R35, R42, R45, R47, R48, R50, R52, R53, R54, R58, R59, R60	0	Open, ±1%, 0402 resistors Leave site open
R9, R13, R23, R27, R29, R32, R39, R41, R55, R56	10	0Ω ±0%, 0402 resistors*
R20, R51	2	750Ω ±1%, 0402 resistors*
R21, R22	2	61.9Ω ±1%, 0402 resistors*
R33, R36	2	1kΩ ±0%, trimmer potentiometers Bourns 3296W-1-102LF
R34	1	576Ω ±1%, 0402 resistor; use lead-free parts only
R37	1	332Ω ±1%, 0402 resistor; use lead-free parts only
SYNTH_LDO	1	1 x 3-pin header Sullins PEC36SAAN

DESIGNATION	QTY	DESCRIPTION
SYNTH_LDO	1	Shorting jumper Sullins SSC02SYAN
T1, T2, T4	3	3.6GHz RF baluns Murata LDB182G5010G-120
U1, U3	2	Low-noise-differential ADC drivers ADI AD8139ARDZ
U2, U5, U6, U15	4	Maxim MAX4444ESE+ (16 SO)
U4	1	Maxim MAX2839ASEWO+T
U7	1	Low-dropout linear regulator Maxim MAX8887EZK29+ (5 SOT23)
U8, U9	2	SN74LVTH244ADB Texas Instruments SN74LVTH244ADBR
U10	1	Low-dropout voltage reference Maxim MAX6062AEUR+ (3 SOT23)
U11	1	40MHz TCXO Kyocera KT3225N40000ECV28ZAA
U13	1	Ultra-low-noise LDO Maxim MAX8510EXK29+ (5 SC70)
VCCCP, VCCLNA_A, VCCLNA_B, VCCRBB1, VCCRBB2, VCCRXXM, VCCTCXO, VCCTXXM, VCCVCO, VCCXTAL, VCC_DB, VCC_PAD, VCC_REF	0	Not installed, 1 x 2-pin headers
Y1	0	Not installed, quartz crystal
—	1	PCB: MAX2839AS EVALUATION KIT+

*Use lead-free parts only.

Component Suppliers

SUPPLIER	PHONE	WEBSITE
Analog Device	800-262-5643	www.analog.com
Digi-Key Corp.	800-344-4539	www.digikey.com
Keystone Electronics	800-221-5510	www.keyelco.com
Murata Americas	770-436-1300	www.murataamericas.com

Note: Indicate that you are using the MAX2839AS when contacting these component suppliers.

Quick Start

The MAX2839AS EV kit is fully assembled and factory tested. Follow the instructions in the *Connections and Setup* section to test the devices.

Recommended Test Equipment

This section lists the recommended test equipment to verify the operation of the MAX2839AS. It is intended as a guide only and substitutions may be possible.

- DC supply capable of delivering +5V and 250mA of continuous current
- DC supply capable of delivering -5V and 250mA of continuous current
- DC supply capable of delivering +3.3V and 250mA of continuous current
- One HP 8648 or equivalent signal source capable of generating 0dBm up to 2.7GHz
- Two HP or equivalent arbitrary waveform generators
- One HP 8561E or equivalent RF spectrum analyzer with a minimum 100kHz to 3GHz frequency range
- One HP 437B power meter and power head
- PC laptop or tablet with Microsoft Windows XP®, Windows® 7, 8 OS and a USB port
- USB-A male to USB-B male cable
- US keyboard

Connections and Setup

The EV kit is fully assembled and factory tested. Follow the instructions below to test the devices. This section provides step-by-step instructions for getting the EV kit up and running in all modes:

- 1) Install and run the MAX2839AS control software. Select MAX2839AS Ev.Kt for “select IC” under Options.

Windows and Windows XP are registered trademarks and registered service marks of Microsoft Corporation.

- 2) Connect the PC to the INTF3000 interface board using the USB-A male to USB-B male cable. On INTF3000, place a jumper between pins 1-2 on JU1 (VBUS Pos). Connect the 25-pin connector of the INTF3000 (J4) directly to the 25-pin connector on the EV kit (J18).
- 3) With the power supply turned off, connect the +3.3V power supply to VBAT and VCCAUX. Connect the power-supply ground to the header labeled GND.
- 4) With the power supply turned off, connect the +5V power supply to the +5V pin and the -5V power supply to the -5V pin. Connect the power-supply ground to the header labeled GND. Connect all the power-supply grounds together.
- 5) Set the RXBBBUF jumper across pins 1-2 to enable the Rx baseband buffers.
- 6) Turn on the +3.3V power supply, and the +5V and -5V power supplies.
- 7) In the enables panel of the software, check the EN_SPI box to enable the 3-wire interface.
- 8) Adjust the Tx common-mode potentiometer (R36) until measuring 0.9V common-mode voltage at the VCM test point.
- 9) In the register panel of the software, set ENABLE to 0, and set JPTXRX jumper across pins 1-2 to put the IC into standby mode.
- 10) In the synth panel of the software, set the LO frequency to 2500MHz.

Receive Mode

- 1) Use the power meter to calibrate the RF signal generator to deliver -98dBm at 2501MHz. After calibration, turn the RF signal generator off, disconnect it from the power meter, and connect it to the RXINA port of the EV kit.
- 2) Connect either the I or the Q baseband output of receiver A to a spectrum analyzer. Set the center frequency to 1MHz and the span to 1MHz.

- 3) In the register panel of the software, enter the recommended register setting shown in Figure 1 for operating the MAX2839AS in steady state receive mode bench measurement. This setup fixes the VGA highpass corner at 1kHz.
- 4) Press the Send All button.
- 5) In the register panel of the software, set ENABLE to be 1, and set JPTXRX jumper across pins 1-2 to activate the receive path.
- 6) In the Rx panel of the software, toggle the LNA gain enable and the baseband VGA enable both to be SPI. Set both of the gain controls to be max.
- 7) Turn on the RF signal source. The output CW tone at 1MHz should be approximately 0dBm.

Transmit Mode

- 1) Connect the spectrum analyzer to the TXRF port. Set the center frequency to 2500MHz and the span to 5MHz.
- 2) Connect a 1MHz I/Q signal to pins TXBBI and TXBBQ, respectively. Set the input amplitude of each channel to 90mV_{RMS} with 90° phase shift.
- 3) In the register panel of the software, set ENABLE to 1, and set JPTXRX jumper across pins 2-3 to activate the transmit path.
- 4) In the register panel of the software, enter the recommended register setting shown in Figure 2.
- 5) Press the Send All button.

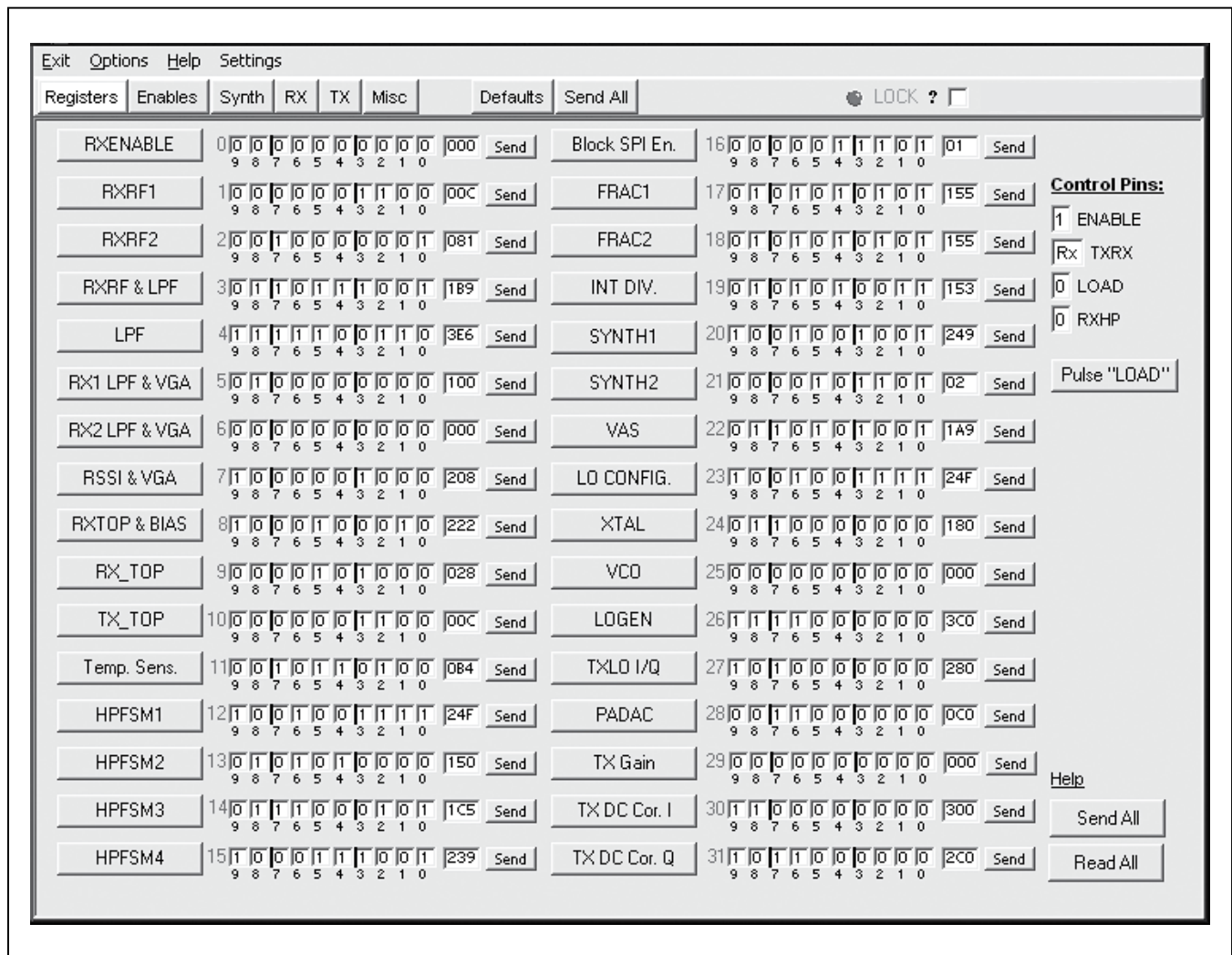

Figure 1. Receive Mode Register Setting

- 6) Enable the output of the baseband signal sources. The desired tone, LO leakage, and the sideband appear at 2501MHz, 2500MHz, and 2499MHz, respectively. Set the Tx VGA gain to be 3dB below the max gain. The power level of the desired tone is approximately -1dBm in the spectrum analyzer marker reading, assuming that the balun on board contributes 1dB of loss.

Layout Considerations

The EV kit can serve as a guide for board layout. Keep PCB trace lengths as short as possible to minimize parasitic inductance. Also, keep decoupling capacitors as close as possible to the IC with a direct connection to the ground plane.

Power-Supply Layout

To minimize coupling between different sections of the IC, use a “star” power-supply routing configuration with a large decoupling capacitor at a central V_{CC} node. The V_{CC} traces branch out from this node, each going to a separate V_{CC} node in the circuit. Place a bypass capacitor as close as possible to each supply pin. This arrangement provides local decoupling at each V_{CC} pin. Use at least one via per bypass capacitor for a low-inductance ground connection. Do not share the capacitor ground vias with any other branch.

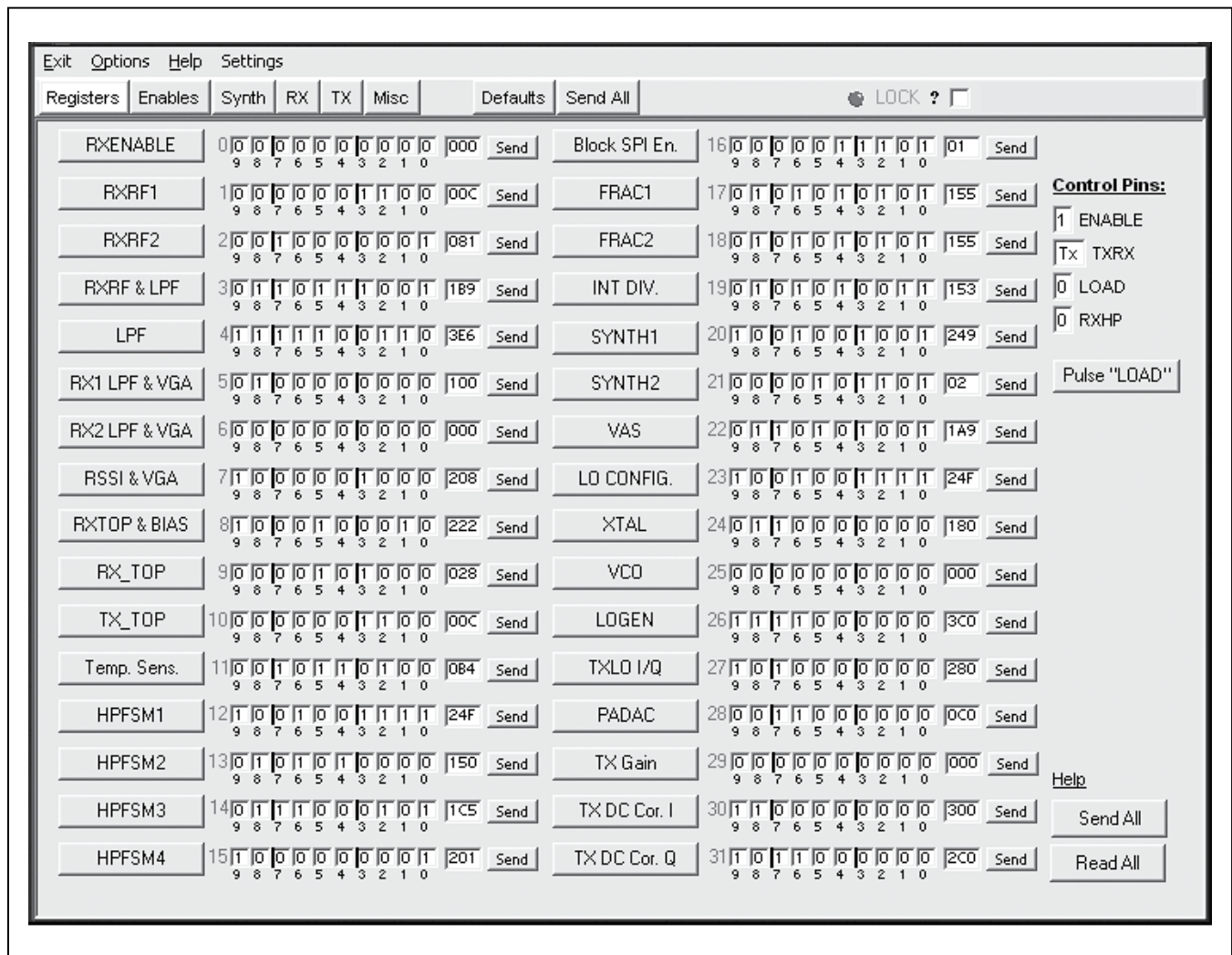

Figure 2. Transmit Mode Register Setting

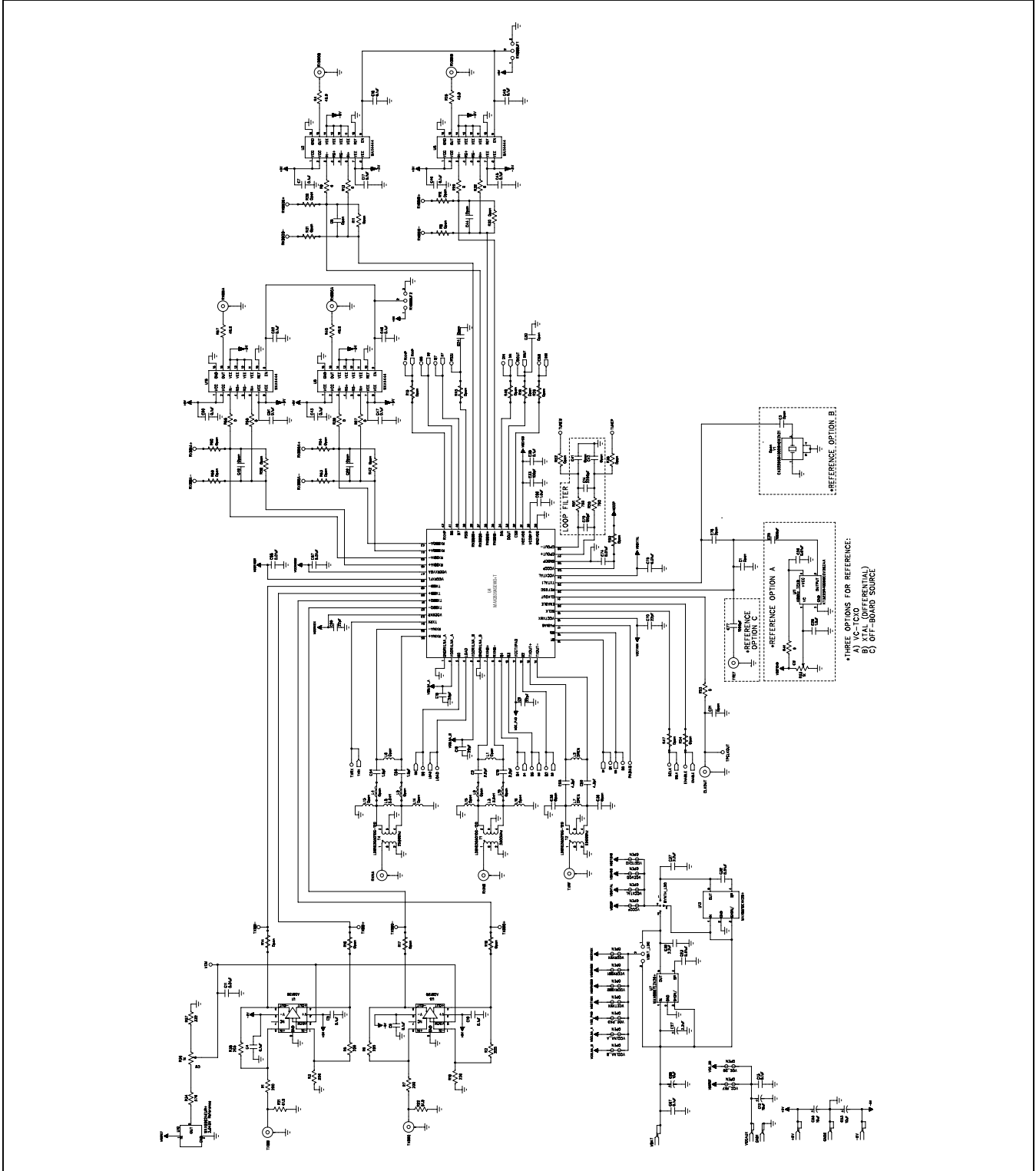

Figure 3a. MAX2839AS EV Kit Schematic (Sheet 1 of 2)

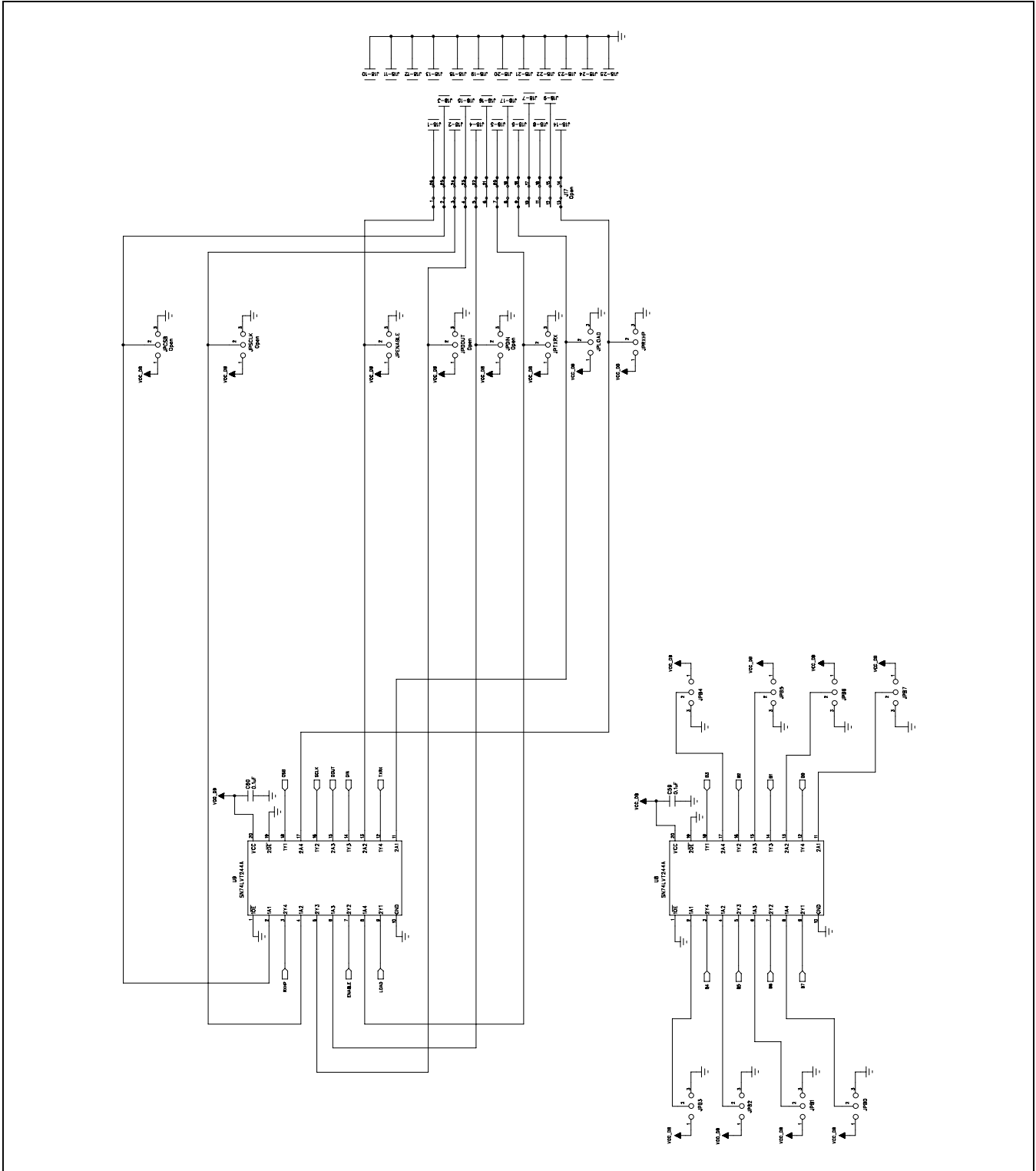

Figure 3b. MAX2839AS EV Kit Schematic (Sheet 2 of 2)

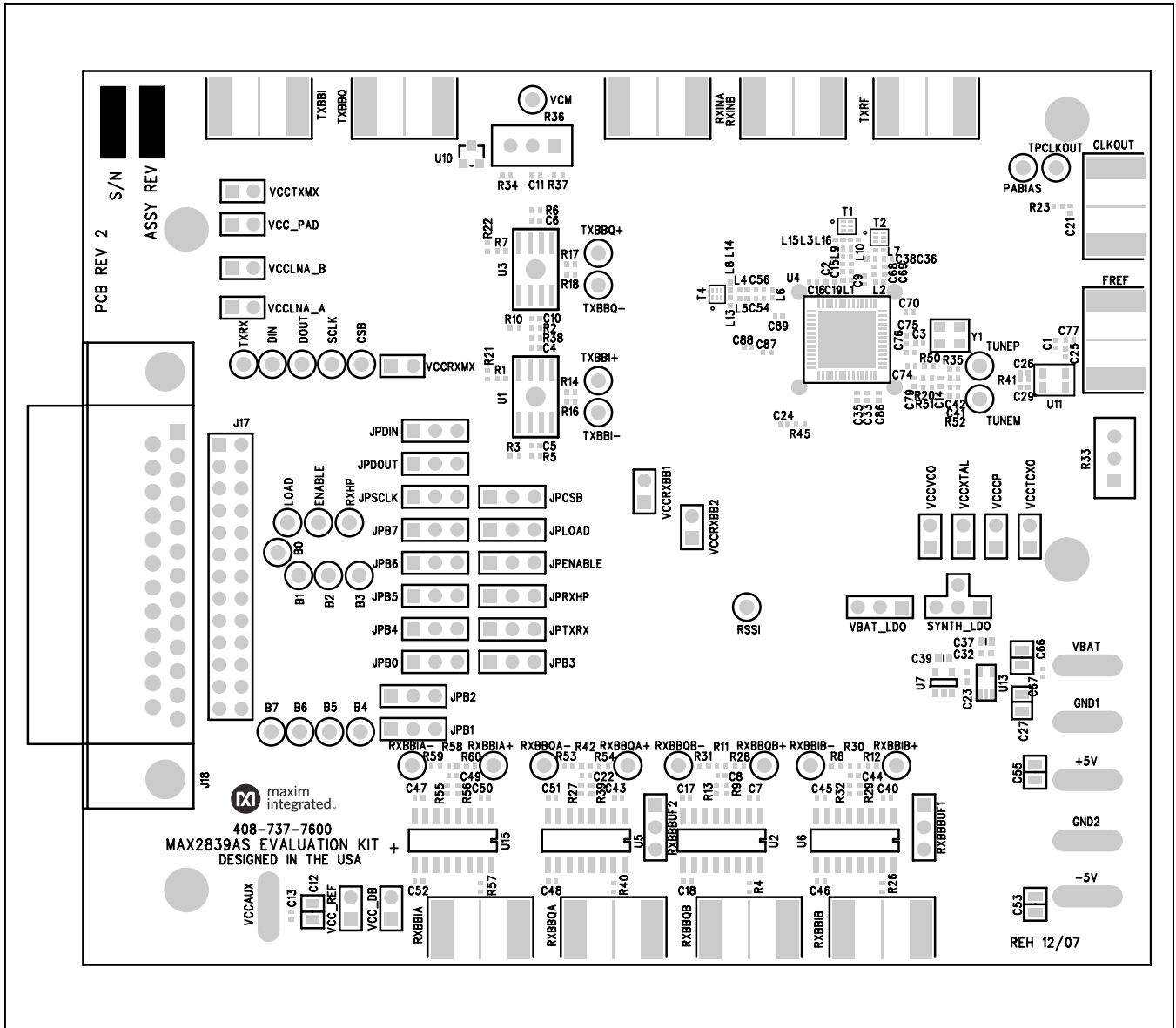

Figure 4. MAX2839AS EV Kit PCB Layout—Top Silkscreen

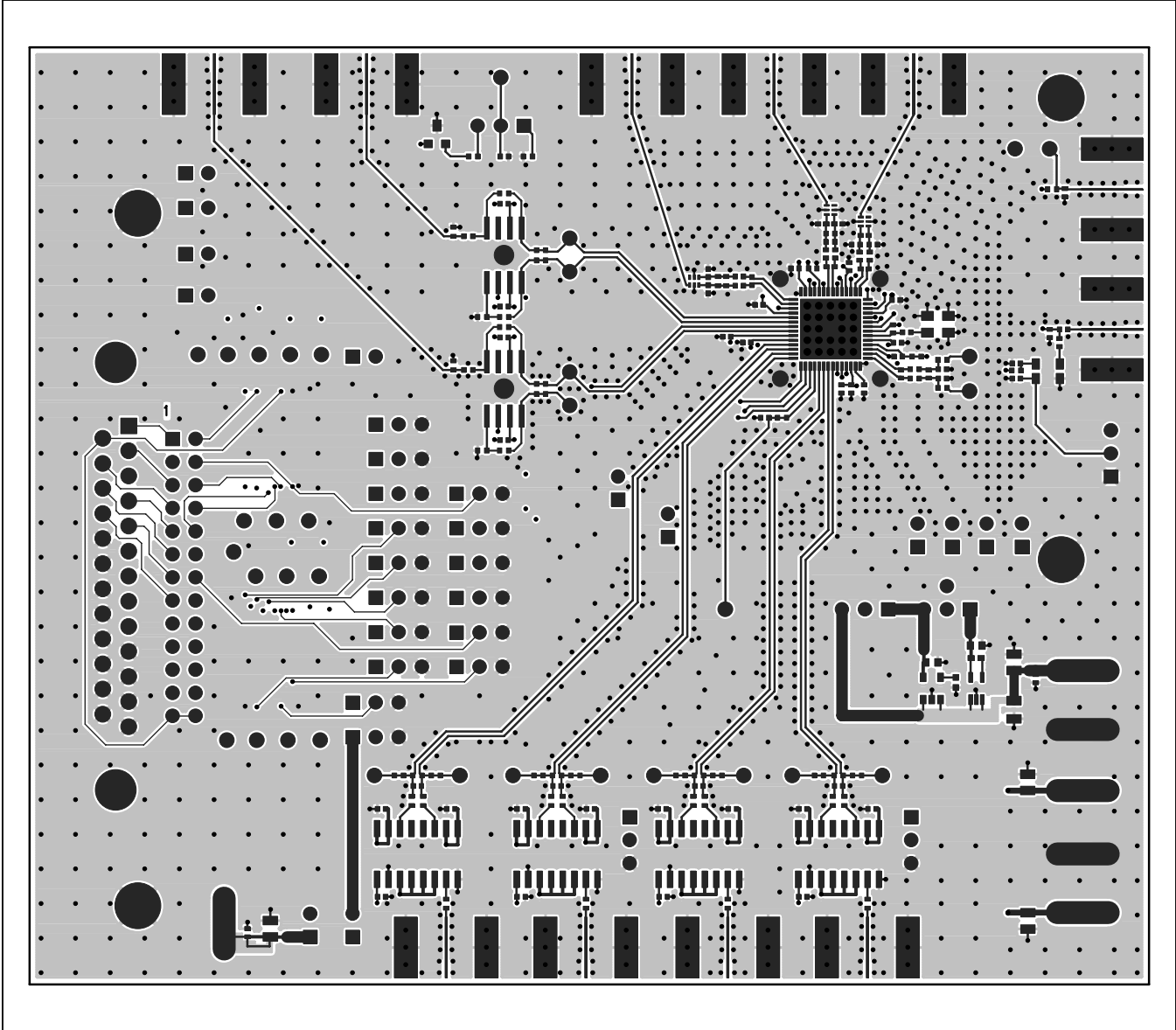

Figure 5. MAX2839AS EV Kit PCB Layout—Component Side

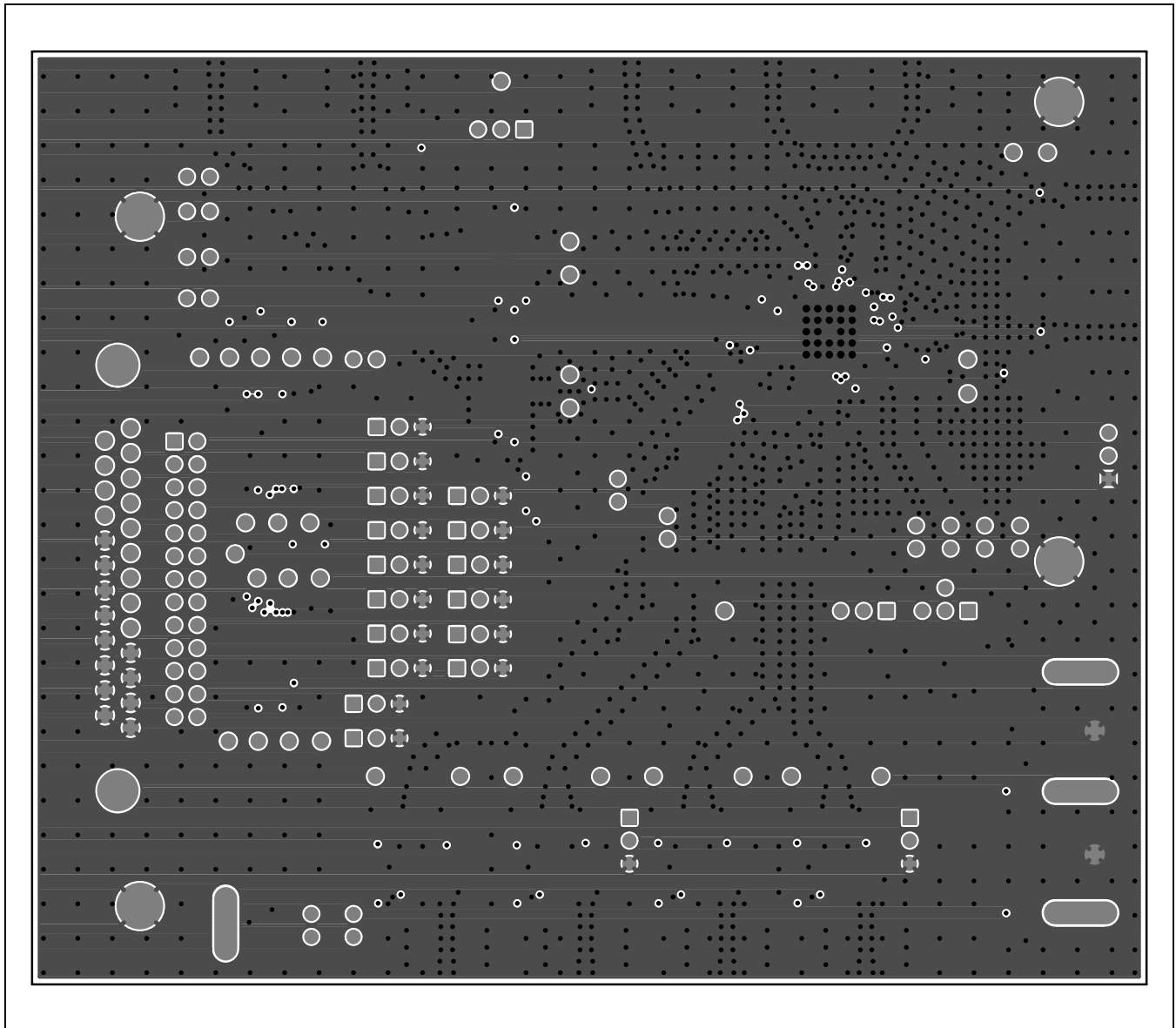

Figure 6. MAX2839AS EV Kit PCB Layout—Inner Layer 2 (Ground Layer)

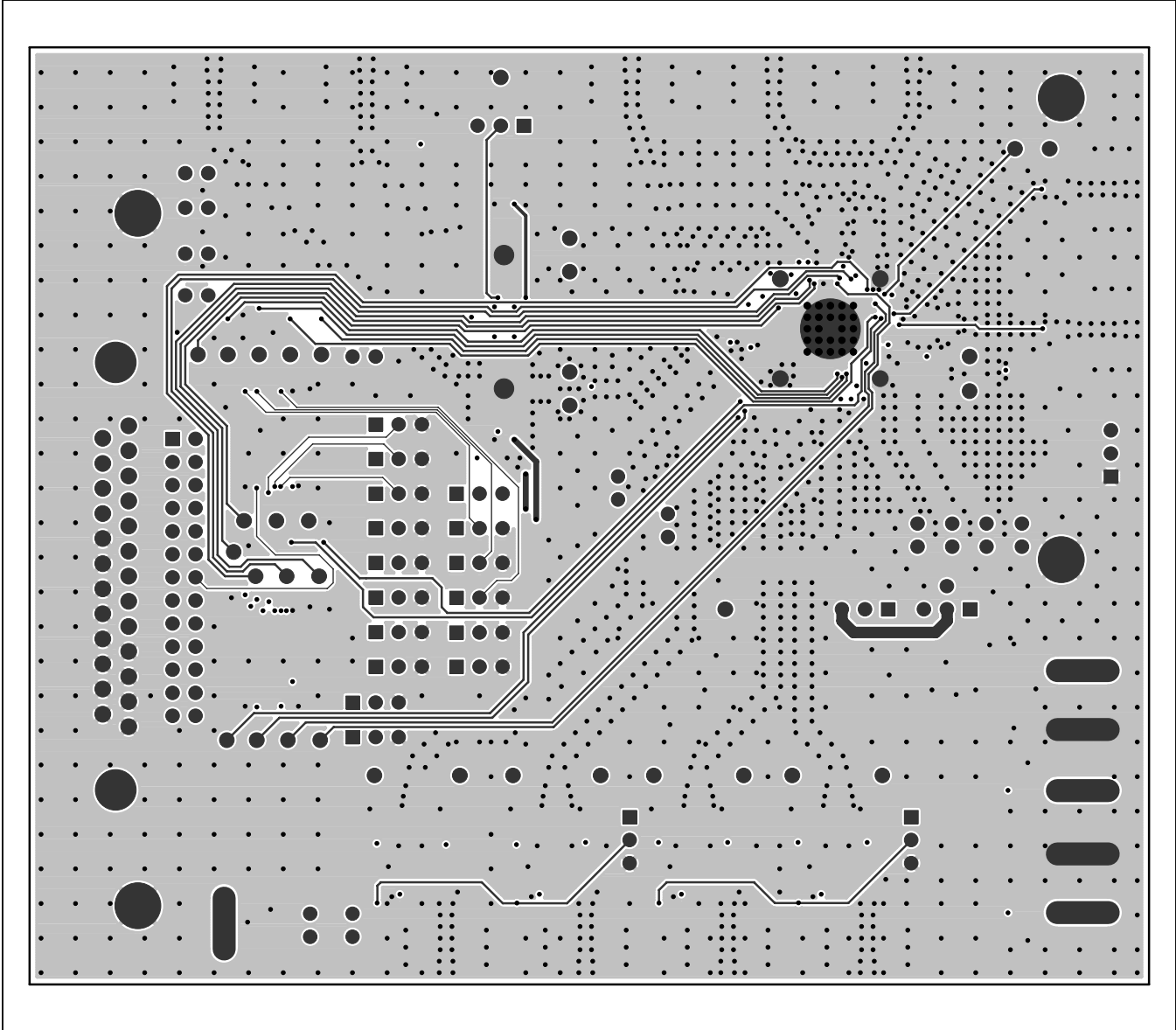

Figure 7. MAX2839AS EV Kit PCB Layout—Inner Layer 3 (Routes)

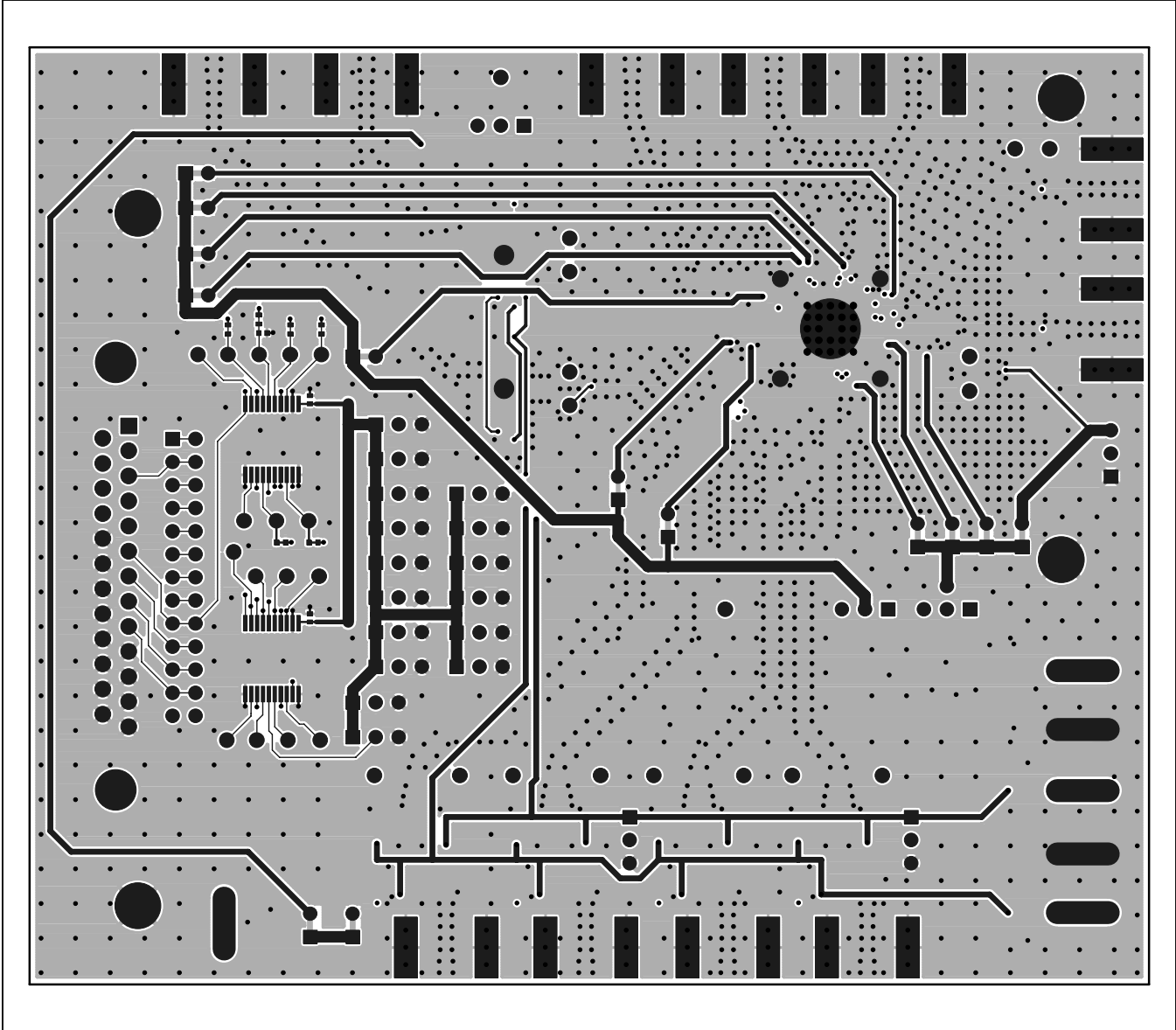

Figure 8. MAX2839AS EV Kit PCB Layout—Solder Side

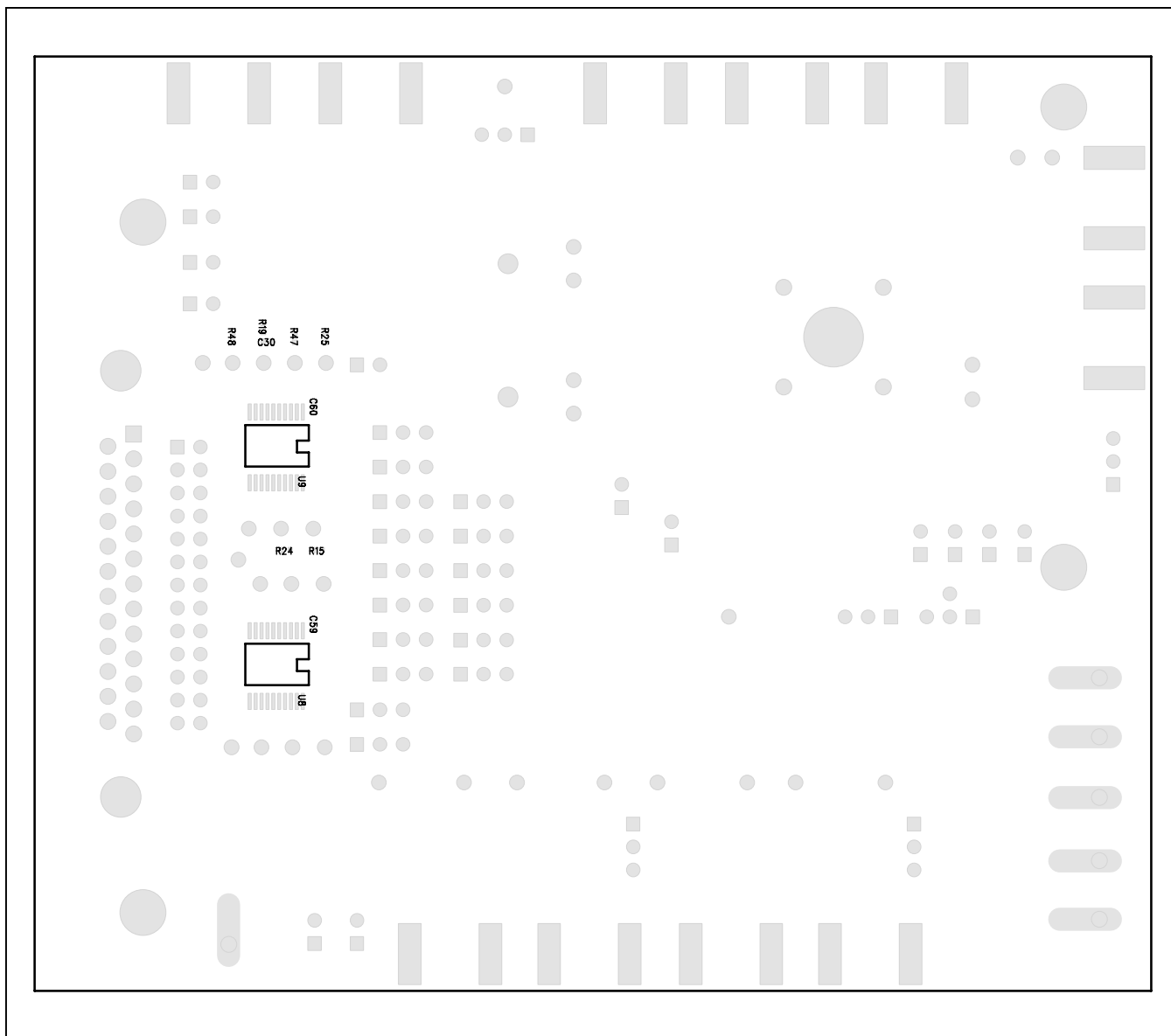

Figure 9. MAX2839AS EV Kit PCB Layout—Bottom Silkscreen

Revision History

REVISION NUMBER	REVISION DATE	DESCRIPTION	PAGES CHANGED
0	4/09	Initial release	—
1	5/10	Changed the part number from MAX2839S to MAX2839AS	1–13
2	11/14	Updated <i>Quick Start</i> section	3

For pricing, delivery, and ordering information, please contact Maxim Direct at 1-888-629-4642, or visit Maxim Integrated's website at www.maximintegrated.com.

Maxim Integrated cannot assume responsibility for use of any circuitry other than circuitry entirely embodied in a Maxim Integrated product. No circuit patent licenses are implied. Maxim Integrated reserves the right to change the circuitry and specifications without notice at any time.