

# CRYSTAL OSCILLATOR TEST & BURN IN SOCKET

AXS-7550-06-03

Precision test socket for 7.5x5.0mm, 6 pad crystal oscillator packages.



**RoHS**  
Compliant

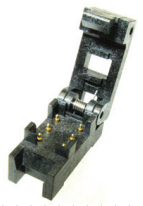

## FEATURES:

- Accurate and reliable testing of frequency control devices
- Contact force ideal for avoiding measurement error
- Highest quality socket available
- Clam shell design for easy open and close
- Reliable gold plated POGO pins
- Suitable for high temperature burn-in test
- Operating Temperature: -30 ~ +150°C

## APPLICATIONS:

- Design stage component engineering evaluation
- Supplier comparison tests
- High temperature burn-in board testing
- Prototyping

## SIDE VIEW (OPEN):

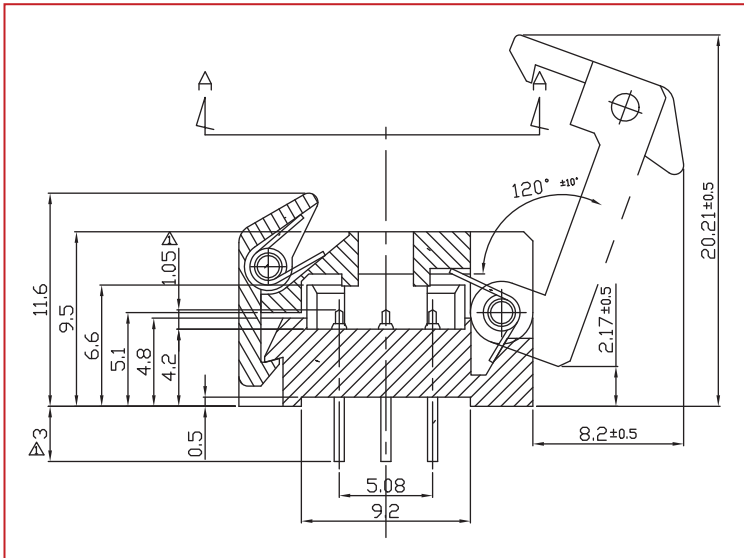

## POCKET TOP VIEW:

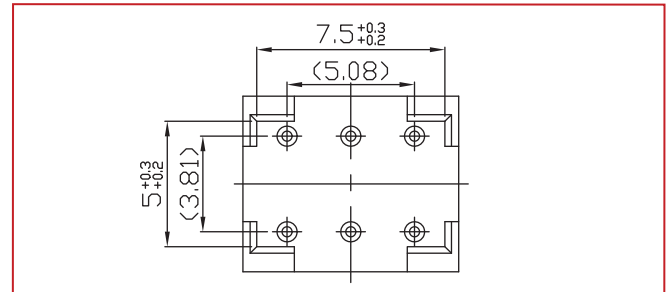

## PIN DIMENSIONS:

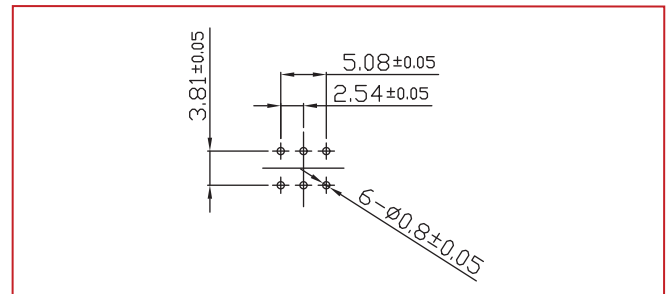

## END VIEW:

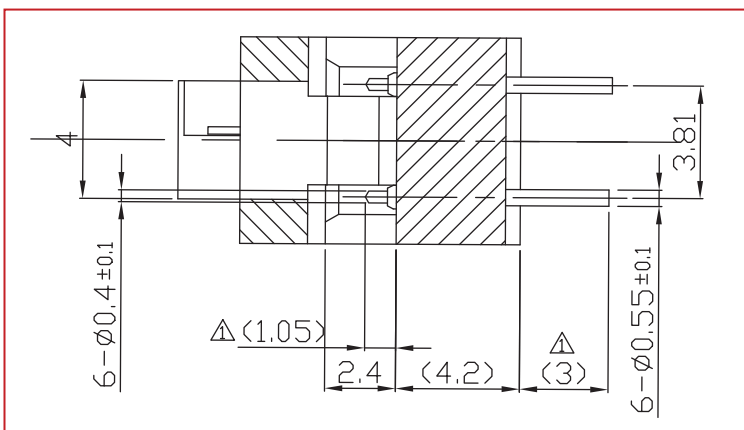

## SUITABLE CRYSTAL OSCILLATOR PACKAGE DIMENSIONS:

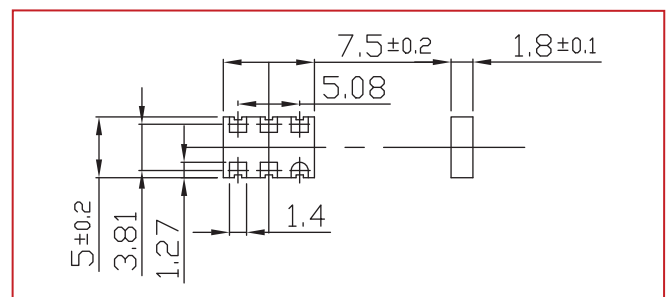

Dimensions: mm

## ORDERING INFORMATION:

When ordering, please refer to part number

**AXS-7550-06-03**

## RECOMMENDED FOR USE WITH DEVICE PACKAGE DIMENSIONS:

**7.5 x 5.0 x 1.8mm**

## COMPATIBLE ABRACON SURFACE MOUNT OSCILLATOR:

**ABFM, ASPE**

(for a pdf download go to [www.abracon.com/oscillators.htm](http://www.abracon.com/oscillators.htm))

\* ABRACON test and burn in sockets are compatible with all industry standard frequency control packages.

ABRACON IS  
ISO 9001 / QS 9000  
CERTIFIED



Visit [www.abracon.com](http://www.abracon.com) for Terms & Conditions of Sale **Revised: 07.13.09**

30332 Esperanza, Rancho Santa Margarita, California 92688

tel 949-546-8000 | fax 949-546-8001 | [www.abracon.com](http://www.abracon.com)