

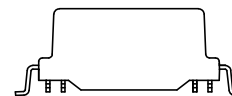

NOTES:

1. ROHS COMPLIANT
2. HEADER: DAP (DIALLYL PHTHALATE) WITH FLAMMABILITY RATING UL 94V-0 OR BETTER.
3. DESIGNED TO SUPPORT HD-BASET AND TESTED WITH VALENS CHIPSET
4. STORAGE TEMPERATURE: -50°C TO +125°C
5. COMPLIANCE TO J-STD:
  - A. J-STD-002: SOLDERABILITY AT 245°C REFLOW PROFILE
  - B. J-STD-020: LEVEL 1, NO MOISTURE SENSITIVE
  - C. J-STD-075: R7, 245°C MAXIMUM THROUGH REFLOW SOLDER
6. TO ORDER TAPE & REEL PACKAGING ADD A "T" SUFFIX TO THE PART NUMBER(i.e HDX8005NL BECOMES HDX8005NLT).

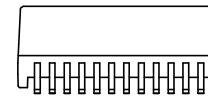
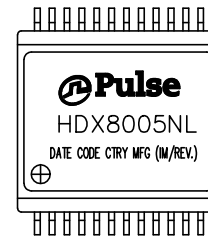

FINAL OUTLINE

© Copyright, 2018. Pulse Electronics Corp. All rights reserved. Pulse confidential & proprietary. (06/29/18)

PRODUCT DESCRIPTION	TLA DRAWING	PS DRAWING	SHEET	PART NO.	DATASHEET REV.
MDL,SIN,HDBT,1:1,POEPP,SM,TU	HDX8005NL-P1	PS-2517.001-B	1 OF 3	HDX8005NL	C

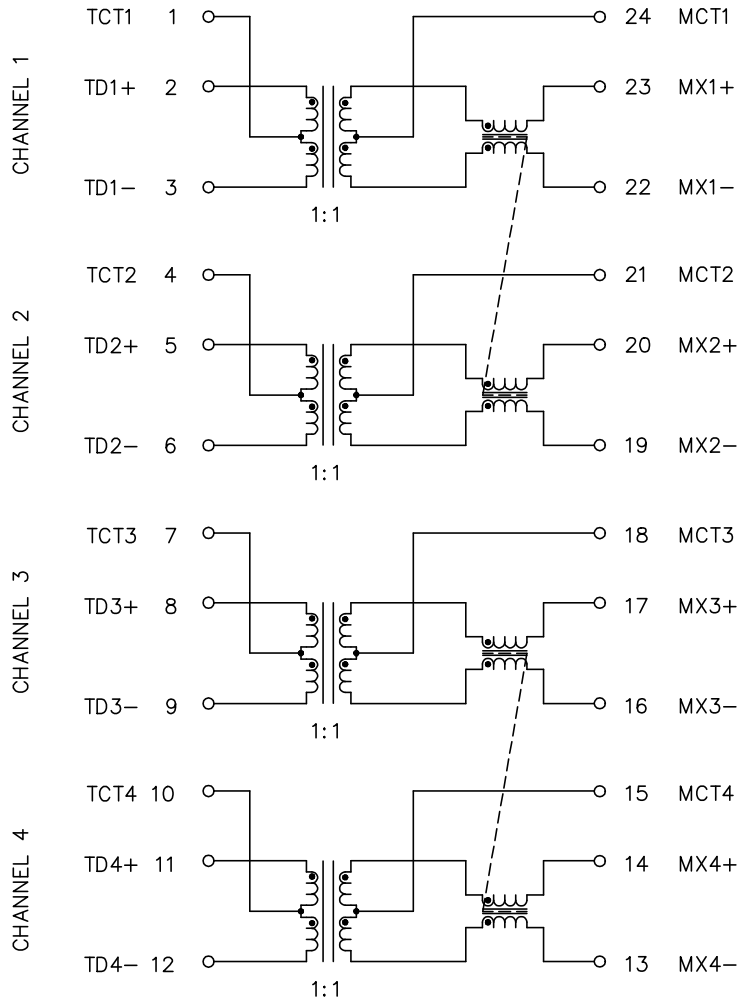

SCHEMATIC

ELECTRICAL CHARACTERISTICS AT +25°C UNLESS OTHER SPECIFIED  
MEETS IEEE 802.3 SPECIFICATION

PARAMETER	SPECIFICATIONS		
OPERATING TEMPERATURE	-40°C TO +85°C		
TURNS RATIO	1.00 ± 2%		
POLARITY	PER SCHEMATIC		
INSERTION LOSS (SDD21)	100 KHz	1-400 MHz	
	-3.0 dB MAX	-2.0 dB MAX (-1.0 dB TYP)	
PHY-SIDE RETURN LOSS (SDD11 - Zref = 100 OHMS ± 1%)	1 MHz-40 MHz	100 MHz-400 MHz	
	-20 dB MIN	-20+12*LOG <sub>10</sub> (f/40) dB MIN	
LINE-SIDE RETURN LOSS (SDD22 - Zref = 100 OHMS ± 1%)	1 MHz - 40 MHz	40 MHz - 400 MHz	
	-20 dB MIN	-20+12*LOG <sub>10</sub> (f/40) dB MIN	
INDUCTANCE (OCL)	120 uH MIN @ 100 kHz, 100 mV WITH 15 mA DC BIAS		
CROSSTALK, ADJACENT CHANNELS (SDD21 - ADJ.)	1-100 MHz	100-400 MHz	
	-33 dB MIN	-22 dB MIN	
COMMON MODE REJECTION RATIO (SCC21)	1 MHz-100 MHz	100-300 MHz	300-500 MHz
	-37 dB MIN	-30 dB MIN	-25 dB MIN
COMM. TO DIFF. REJECTION RATIO (SDC12)	1 MHz-100 MHz	100-300 MHz	300-500 MHz
	-40 dB MIN	-30 dB MIN	-25 dB MIN
DC CURRENT CARRING CAPABILITY	900 mA MAX AT 57 VDC		
INPUT - OUTPUT ISOLATION	1500 VRMS MIN @ 60 SECONDS		

NOTE: f IS FREQUENCY IN MHZ.

© Copyright, 2018. Pulse Electronics Corp. All rights reserved. Pulse confidential & proprietary. (06/29/18)

PRODUCT DESCRIPTION	TLA DRAWING	PS DRAWING	SHEET	PART NO.	DATASHEET REV.
MDL,SIN,HDBT,1:1,POEPP,SM,TU	HDX8005NL-P1	PS-2517.001-B	2 OF 3	HDX8005NL	C

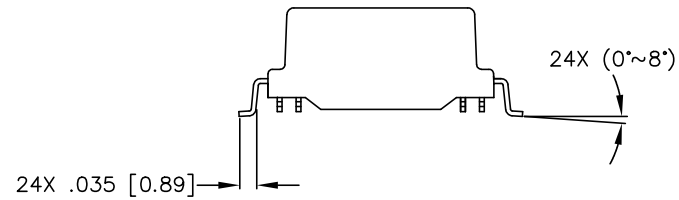
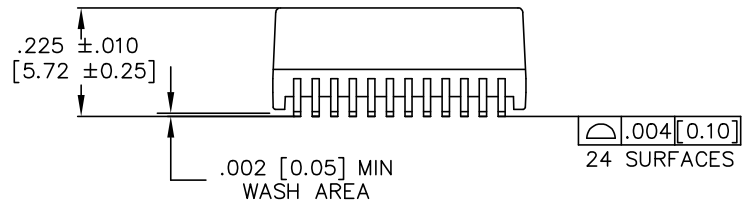
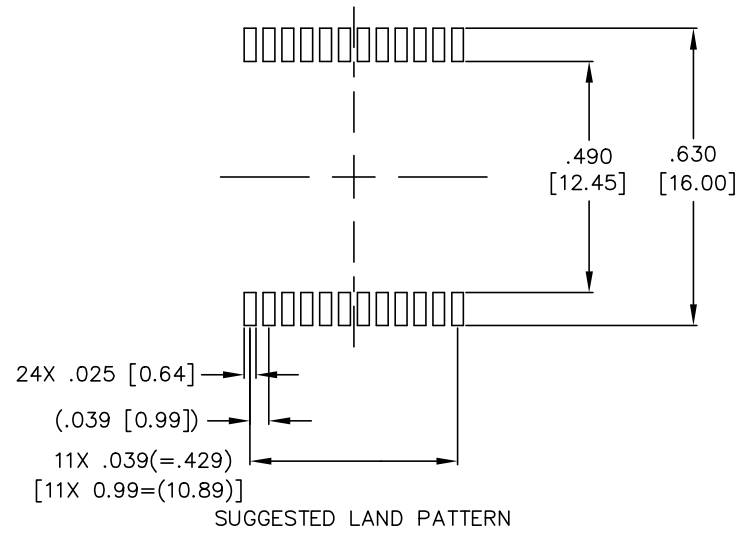
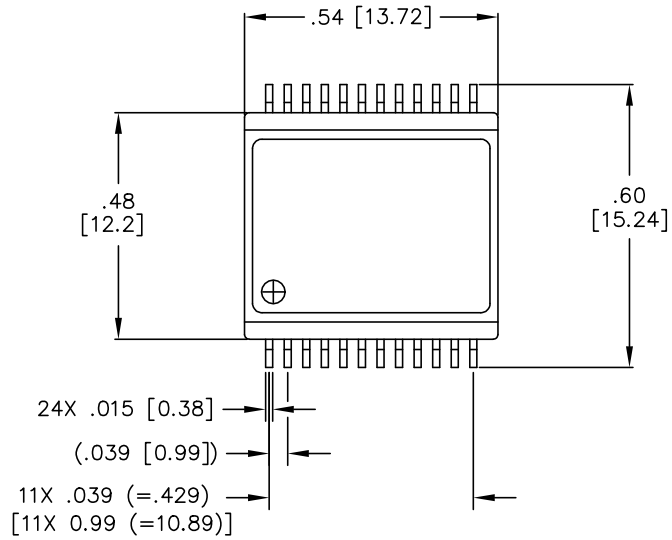

DIMENSIONS ARE IN INCHES [MILLIMETERS] WITH THE FOLLOWING TOLERANCES: [MILLIMETERS] ARE FOR REFERENCE ONLY.  
 .XX= ±.01 [±0.25]  
 .XXX= ±.005 [±0.13]

© Copyright, 2018. Pulse Electronics Corp. All rights reserved. Pulse confidential & proprietary. (06/29/18)

PRODUCT DESCRIPTION	TLA DRAWING	PS DRAWING	SHEET	PART NO.	DATASHEET REV.
MDL,SIN,HDBT,1:1,POEPP,SM,TU	HDX8005NL-P1	PS-2517.001-B	3 OF 3	HDX8005NL	C