

RSC Series

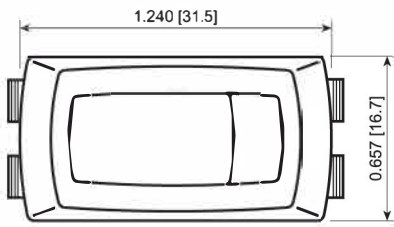

ROCKER



Panel Cutout

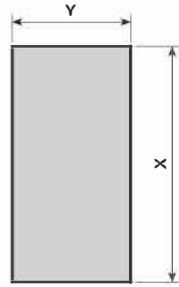

	X	Y
RSC1-Series	1.126 [28.6]	0.547 [13.9]
RSC2-Series	1.071 [27.2]	0.476 [12.1]
RSC3-Series	1.071 [27.2]	0.547 [13.9]
RSC4-Series	1.126 [28.6]	0.476 [12.1]

Actuator Options



Bi-Color



Flat

Illumination Options

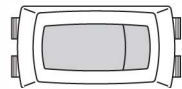

Full

Terminal Options

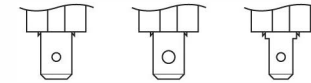

6.3mm Tab (Small Hole) 6.3mm Tab (Large Hole) 4.8mm Tab

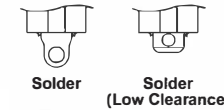

Solder Solder (Low Clearance)

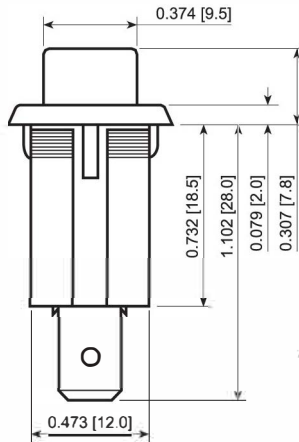
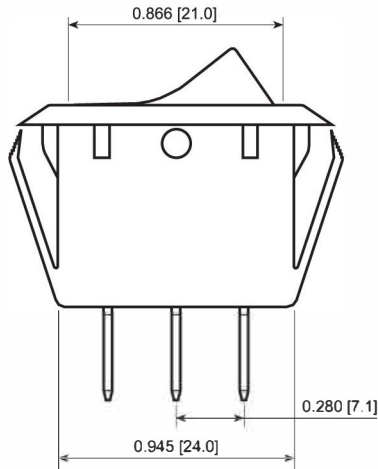

FEATURES:

- Excellent Quality and Reliability
- 4 Bodies to Cover Many Popular Cutouts
- High Current Capacity
- Illuminated and Bi-Color Actuators

SPECIFICATIONS:

RATING: RATING OPTION D:

- 20A 125VAC [UL, CSA]
- 16A 250VAC [UL, CSA]
- 1/4HP 125VAC [UL]
- 3/4HP 250VAC [UL]

RATING OPTION C:

- 15A 125VAC [UL, CSA]

TEMPERATURE: -20°C to 65°C [UL, CSA]
-20°C to 105°C [UL, CSA]

ELECTRICAL LIFE: 10,000 Cycles
CONTACT RESISTANCE: 20mΩ Max. at 1A 5VDC
INSULATION RESISTANCE: 100MΩ Min. at 500VDC
DIELECTRIC STRENGTH: 1,000VAC for 1 Minute



RSC341D1123



RSC241D2200



RSC241D125Z11

RSC141D1A24



RSC141D1021-116

Series	Terminal	Function	Rating	Body Color	Actuator Color	Marking Color	Marking Type	Lens Style	Lens Color	Lamp Voltage
<input type="checkbox"/>	<input type="checkbox"/>	<input type="checkbox"/>	<input type="checkbox"/>	<input type="checkbox"/>	<input type="checkbox"/>	<input type="checkbox"/>	<input type="checkbox"/>	<input type="checkbox"/>	<input type="checkbox"/>	<input type="checkbox"/>
Curved Actuators:	1 - 4.8mm Tab	1 - Off-On (*)	C - 15A 125V	1 - Black	0 - Full Illum.	0 - None	0 - None	1 - Full	0 - Clear	3 - 6V
RSC1 - 28.6 x 13.9 Cutout	4 - 6.3mm Tab (Small Hole)	3 - On-On	D - 20A 125V	2 - White	1 - Black	1 - Black	1 - I/O Vert.	1 - Red	1 - Red	4 - 12V
RSC2 - 27.2 x 12.1 Cutout	4 - Off-(On)	4 - Off-(On)		3 - Almond	2 - White	2 - White	2 - ON/OFF/ON Vert.	2 - Amber	2 - Amber	5 - 24V
RSC3 - 27.2 x 13.9 Cutout	5 - Solder	5 - On-Off-On		4 - Grey	3 - Almond	3 - Almond	3 - ON/OFF Vert.	3 - Green	3 - Green	6 - 125V
RSC4 - 28.6 x 12.1 Cutout	9 - 6.3mm Tab (Large Hole)	A - On-(Off)		9 - Red	4 - Grey	4 - Grey	4 - ON/OFF Horiz.	4 - Blue	4 - Blue	7 - 250V
	C - Solder (Low Clearance)	B - On-(On)			5 - Orange	5 - Orange	5 - I/O Horiz.			
		C - On-Off-(On)			7 - Blue	7 - Blue	R - I/O Horiz.			
					8 - Green	8 - Green	S - I/O Vert.			
					9 - Red	9 - Red				

Note:
* = Option Available with Illumination

Bi-Color:
A - Black / Red
B - Black / White
C - White / Red

Custom Colors and Markings Available Upon Request For Illuminated Switches Only

EXAMPLE PART NUMBERS:

- RSC141D1000-126 1P Off-On
Black Body, Amber Illum. Actuator, 125V
- RSC141D1100 1P Off-On
Black Body/Actuator, No Marking
- RSC141D1121 1P Off-On
Black Body/Actuator, I/O Vert.
- RSC141D2200 1P Off-On
White Body/Actuator, No Marking



E-SWITCH®

www.e-switch.com

800.867.2717

SPECIFICATIONS SUBJECT TO CHANGE WITHOUT NOTICE 11.16.2021