

DRAP124

Automotive grade high power density, shielded drum core power inductors

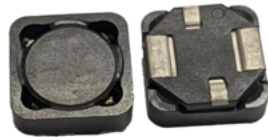

Product features

- AEC-Q200 qualified
- Secure four terminal mounting ideal for severe vibration environments up to 30 g.
- Rugged construction for high shock conditions
- Magnetically shielded-reduces EMI
- Inductance range from 0.42 μ H to 1001 μ H
- Current range from 0.38 A to 30.8 A
- 12.5 mm x 12.5 mm x 4.6 mm surface mount package
- Ferrite core material
- Weight: 2.32 grams typical
- Moisture Sensitivity Level: 1

Applications

- Body electronics
 - LED lighting (interior and exterior)
 - Central body control module
 - Vehicle access control module
 - Headlamps, tail lamps and interior lighting
 - Heating ventilation and air conditioning controllers (HVAC)
 - Doors, window lift and seat control
- Advanced driver assistance systems
 - Adaptive cruise control (ACC)
 - Automatic parking control
 - Collision avoidance system/ Car black box system
- Infotainment and cluster electronics
 - Audio subsystem: head unit and trunk amp
 - Digital instrument cluster
 - In-vehicle infotainment (IVI) and navigation
- Chassis and safety electronics
 - Electronic stability control system (ESC)
 - Electric parking brake
 - Electronic power steering (EPS) / Anti-locking braking system (ABS)
- Engine and powertrain systems
 - Electric pumps, motor control and auxiliaries
 - Powertrain control module (PCU)/ Engine control unit (ECU)
 - Transmission control unit (TCU)

Environmental compliance and general specifications

- Storage temperature range (Component): -40 °C to +165 °C
- Operating temperature range: -40 °C to +165 °C (ambient plus self-temperature rise)
- Solder reflow temperature: J-STD-020 (latest revision) compliant



Product specifications

Part number ⁶	OCL ¹ (μH) ±20%	I _{rms} ² (A)	I _{sat} 1 ³ (A)	I _{sat} 2 ⁴ (A)	DCR (Ω) typical @ +25 °C	DCR (Ω) maximum @ +25 °C	K Factor ⁵
DRAP124-R47-R	0.42	13.5	30.8	24.6	0.0024	0.0028	196.9
DRAP124-1R0-R	0.82	11.65	22.0	17.6	0.0031	0.0038	140.7
DRAP124-1R5-R	1.36	9.36	17.1	13.7	0.0049	0.0058	109.4
DRAP124-2R2-R	2.04	7.64	14.0	11.2	0.0070	0.0090	89.5
DRAP124-3R3-R	2.79	6.94	11.9	9.48	0.0090	0.011	75.7
DRAP124-4R7-R	4.74	5.47	9.06	7.25	0.014	0.017	57.9
DRAP124-6R8-R	7.28	4.46	7.33	5.87	0.021	0.026	46.9
DRAP124-8R2-R	8.88	3.87	6.70	5.36	0.028	0.034	42.8
DRAP124-100-R	10.4	3.67	6.16	4.93	0.031	0.038	39.4
DRAP124-150-R	14.1	3.10	5.31	4.25	0.044	0.053	34.0
DRAP124-220-R	23.0	2.44	4.16	3.33	0.071	0.086	26.6
DRAP124-330-R	34.1	1.98	3.42	2.74	0.108	0.130	21.9
DRAP124-470-R	46.3	1.78	2.91	2.33	0.134	0.160	18.6
DRAP124-680-R	69.8	1.45	2.37	1.90	0.201	0.241	15.1
DRAP124-820-R	80.6	1.29	2.23	1.79	0.257	0.309	14.3
DRAP124-101-R	98.8	1.20	2.00	1.60	0.296	0.355	12.8
DRAP124-151-R	152	0.967	1.62	1.30	0.454	0.550	10.4
DRAP124-221-R	209	0.865	1.36	1.09	0.568	0.680	8.7
DRAP124-331-R	326	0.690	1.09	0.874	0.892	1.070	7.0
DRAP124-471-R	473	0.568	0.911	0.729	1.32	1.58	5.8
DRAP124-681-R	682	0.466	0.759	0.607	1.96	2.35	4.9
DRAP124-821-R	826	0.406	0.697	0.557	2.57	3.09	4.5
DRAP124-102-R	1001	0.380	0.629	0.503	2.94	3.52	4.0

1. Open circuit inductance (OCL) test parameters: 100 kHz, 0.25 Vrms, 0.0 Adc, +25 °C

2. I_{rms}: DC current for an approximate temperature rise of 40 °C without core loss. Derating is necessary for AC currents. PCB layout, trace thickness and width, air-flow, and proximity of other heat generating components will affect the temperature rise. It is recommended that the temperature of the part not exceed +165 °C under worst case operating conditions verified in the end application.

3. I_{sat}1: Peak current for approximately 30% rolloff @ +25 °C

4. I_{sat}2: Peak current for approximately 40% rolloff @ +125 °C

5. K-factor: Used to determine Bp-p for core loss (see graph). Bp-p = K * L * ΔI. Bp-p:(Gauss), K: (K-factor from table), L: (Inductance in μH), ΔI (Peak-to-peak ripple current in Amps).

6. Part Number Definition: DRAP124-xxx-R

DRAP124= Product code and size

xxx= Inductance value in μH, R= decimal point, If no R is present last character equals number of zeros

-R suffix = RoHS compliant

DRAP124
Automotive grade high power density,
shielded drum core power inductors

Technical Data 11040
 Effective March 2020

Dimensions (mm)

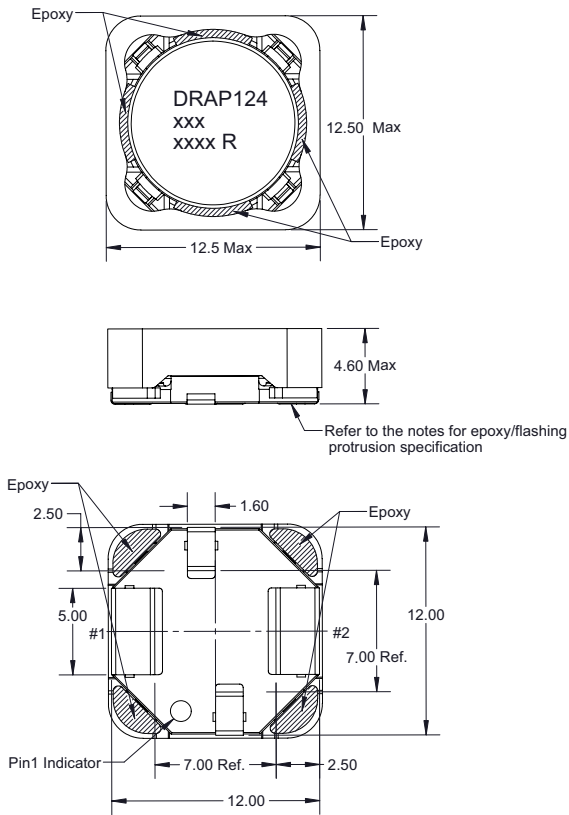

Recommended pad layout

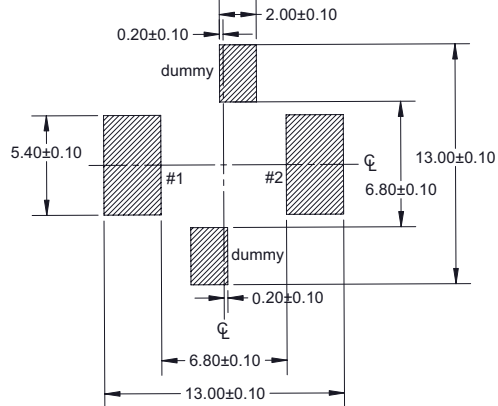

Schematic

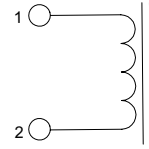

Part marking: DRAP124, xxx= inductance value in uH, R= decimal point, if no R is present last character equals number of zeros, xxxx=lot code, R= Revision level

All soldering surface to be coplanar within 0.1 millimeters
 Tolerances are ±0.2 millimeters unless stated otherwise
 Special Characteristic epoxy protrusion or any flashing from the plastic on the header/base can be below the terminal surface and must not exceed 0.08 mm beyond the bottom surface of the terminal.

Terminal pads shall protrude the plastic base 0.00~0.08 mm
 Traces or vias underneath the inductor is not recommended

Packaging information (mm)

Supplied in tape and reel packaging , 750 parts per 13" diameter reel

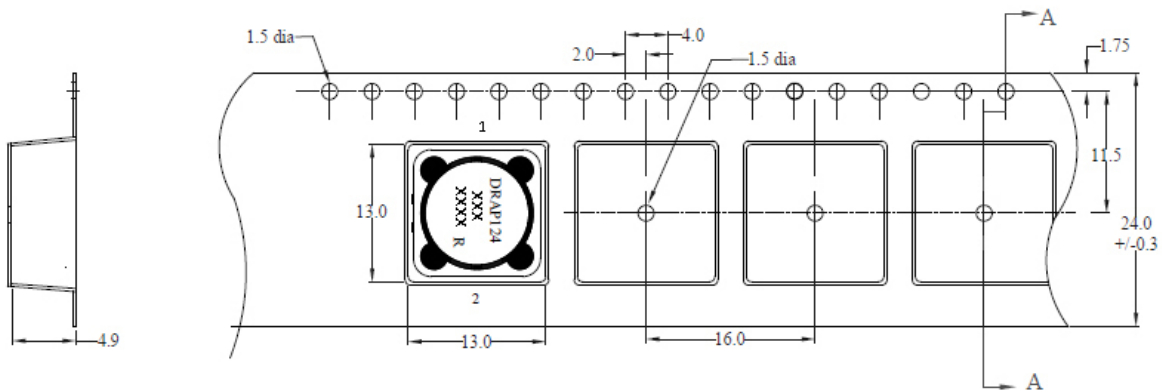

Temperature rise vs. total loss

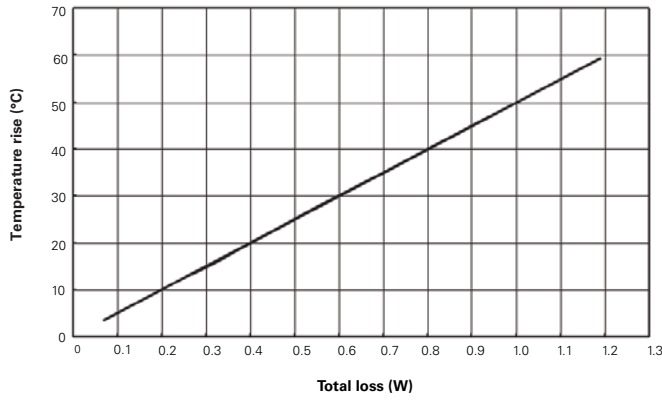

Core loss vs. Bp-p

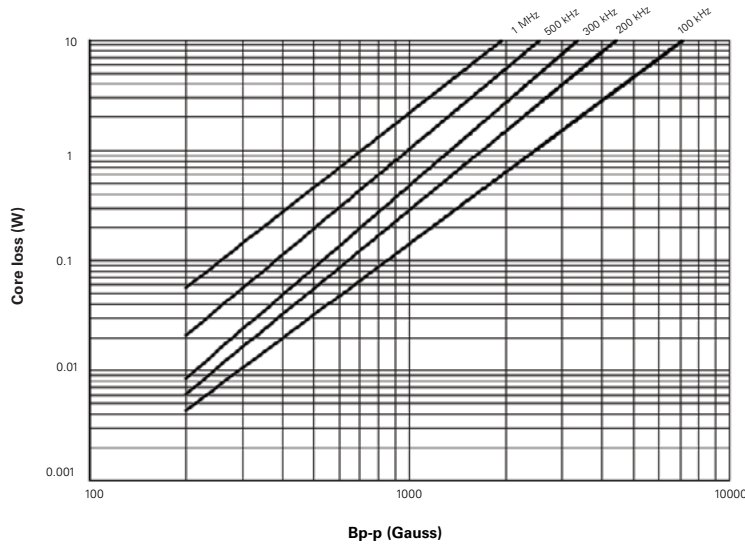

Inductance characteristics

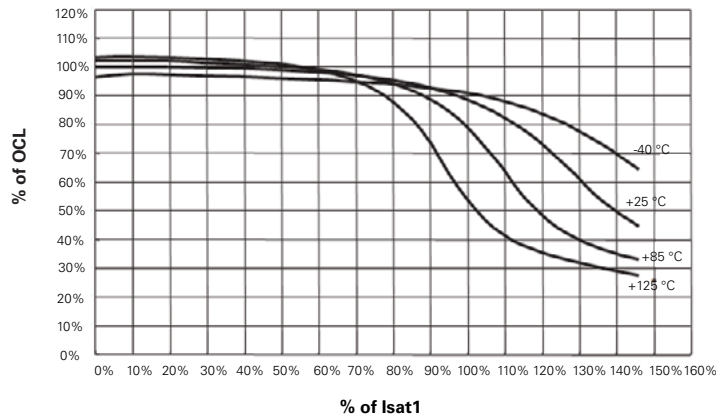

Solder reflow profile

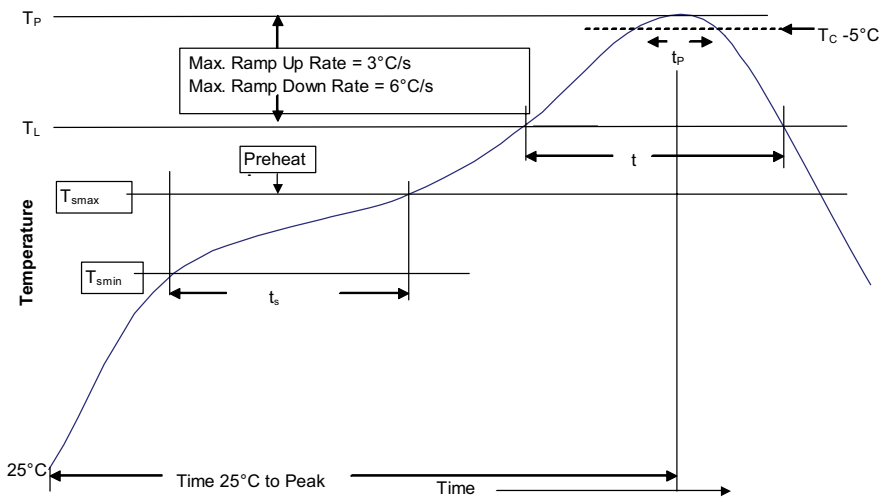

Table 1 - Standard SnPb solder (T_C)

Package thickness	Volume mm ³ <350	Volume mm ³ ≥350
<2.5 mm	235 °C	220 °C
≥2.5 mm	220 °C	220 °C

Table 2 - Lead (Pb) free solder (T_C)

Package thickness	Volume mm ³ <350	Volume mm ³ 350 - 2000	Volume mm ³ >2000
<1.6 mm	260 °C	260 °C	260 °C
1.6 – 2.5 mm	260 °C	250 °C	245 °C
>2.5 mm	250 °C	245 °C	245 °C

Reference J-STD-020

Profile feature	Standard SnPb solder	Lead (Pb) free solder
Preheat and soak	<ul style="list-style-type: none"> Temperature min. (T_{smin}) Temperature max. (T_{smax}) Time (T_{smin} to T_{smax}) (t_s) 	<ul style="list-style-type: none"> 100 °C 150 °C 60-120 seconds
Ramp up rate T_L to T_p	3 °C/ second max.	3 °C/ second max.
Liquidous temperature (T_L) Time (t_L) maintained above T_L	<ul style="list-style-type: none"> 183 °C 60-150 seconds 	<ul style="list-style-type: none"> 217 °C 60-150 seconds
Peak package body temperature (T_p)*	Table 1	Table 2
Time (t_p)* within 5 °C of the specified classification temperature (T_C)	20 seconds*	30 seconds*
Ramp-down rate (T_p to T_L)	6 °C/ second max.	6 °C/ second max.
Time 25 °C to peak temperature	6 minutes max.	8 minutes max.

* Tolerance for peak profile temperature (T_p) is defined as a supplier minimum and a user maximum.

Life Support Policy: Eaton does not authorize the use of any of its products for use in life support devices or systems without the express written approval of an officer of the Company. Life support systems are devices which support or sustain life, and whose failure to perform, when properly used in accordance with instructions for use provided in the labeling, can be reasonably expected to result in significant injury to the user.

Eaton reserves the right, without notice, to change design or construction of any products and to discontinue or limit distribution of any products. Eaton also reserves the right to change or update, without notice, any technical information contained in this bulletin.

Eaton
Electronics Division
1000 Eaton Boulevard
Cleveland, OH 44122
United States
Eaton.com/electronics

© 2020 Eaton
All Rights Reserved
Printed in USA
Publication No. 11040 BU-MC20015
March 2020

Eaton is a registered trademark.

All other trademarks are property of their respective owners.

Follow us on social media to get the latest product and support information.

