



FEATURES

April 2010

1. This specification shall be applied to photocoupler Model No.

LTV-852/LTV-8D52 as an option.

2. Applicable Models (Business dealing name)

- * Dual-in-line package :

LTV852-V / LTV8D52-V

- * Wide lead spacing package :

LTV852M-V / LTV8D52M-V

- * Surface mounting package :

LTV852S-V / LTV8D52S-V

- * Tape and reel packaging :

LTV852STA1-V / LTV8D52STA1-V

3. The relevant models are the models Approved by VDE according to DIN VDE 0884:1992-06

Approved Model No.: LTV-852 / LTV-852M / LTV-852S / LTV-8D52 / LTV-8D52M /
LTV-8D52S

VDE approved No.: 40015248

(According to the specification DIN VDE 0884:1992-06)

- * Operating isolation voltage V_{IORM} : 850V (Peak)

- * Transient voltage V_{TR} : 6000V (Peak)

- * Pollution : 2 (According to VDE 0110-1 : 1997-04)

- * Clearances distance (Between input and output) : 7.0mm (MIN.)

- * Creepage distance (Between input and output) : 7.0mm (MIN.)

- * Isolation thickness between input and output : 0.4mm (MIN.)

- * Safety limit values Current (Isi) : 400mA (Diode side)

Power (Psi) : 700mW (Phototransistor side)

Temperature (Tsi) : 175°C

In order to keep safety electric isolation of photocoupler, please set the protective circuit to keep within safety limit values when the actual application equipment troubled.

- * Indication of VDE 0884 approval prints "  " on sleeve package.

OUTLINE DIMENSIONS

LTV852-V :

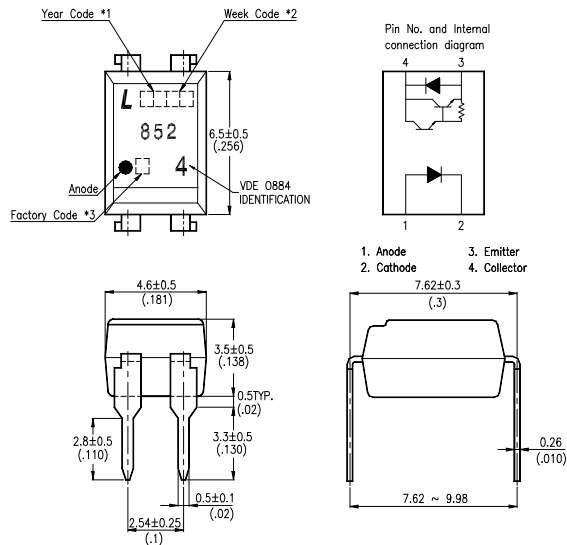

LTV8D52-V :

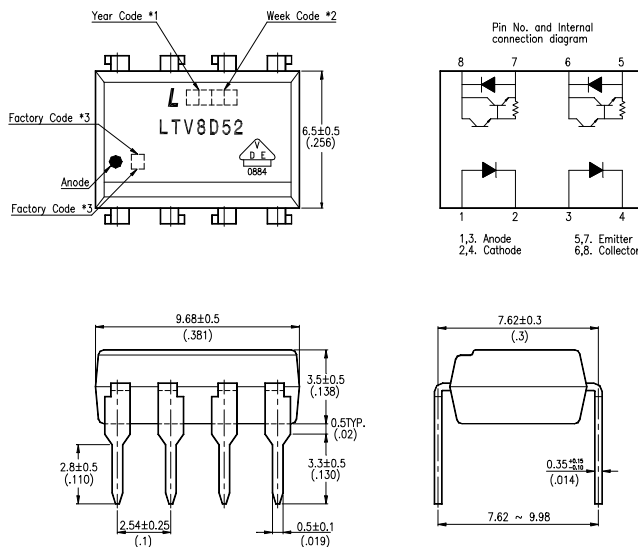

- *1. Year date code.
- *2. 2-digit work week.
- *3. Factory identification mark shall be marked.
(Z : Taiwan, Y : Thailand, X : China-TJ, W : China-CZ)

OUTLINE DIMENSIONS

LTV852M-V :

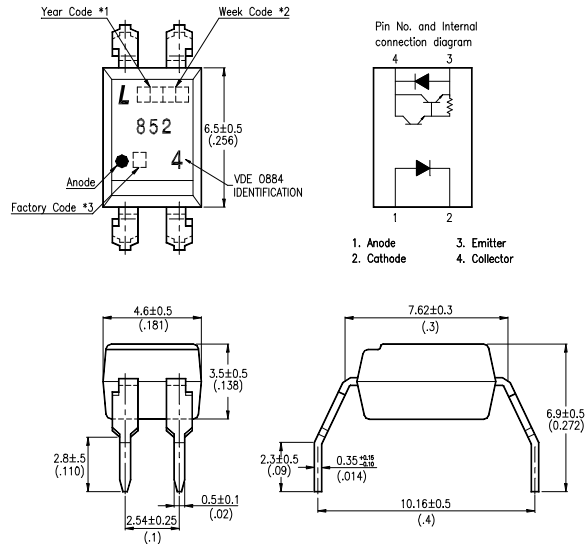

LTV8D52M-V :

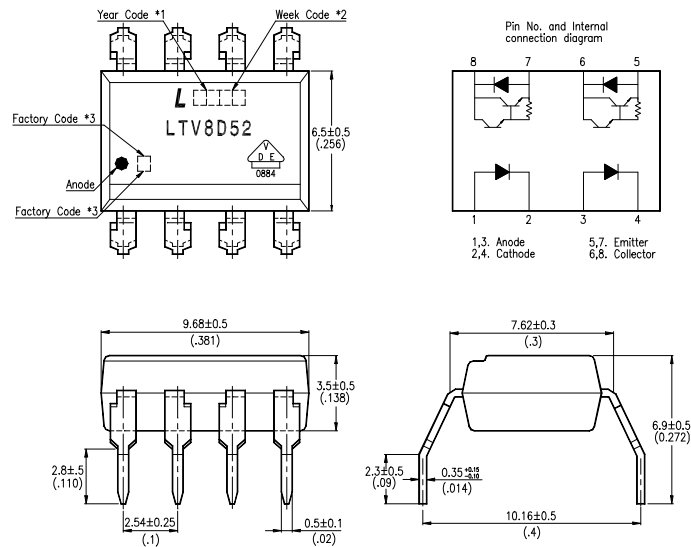

- *1. Year date code.
- *2. 2-digit work week.
- *3. Factory identification mark shall be marked.
(Z : Taiwan, Y : Thailand, X : China-TJ, W : China-CZ)

OUTLINE DIMENSIONS

LTV852S-V :

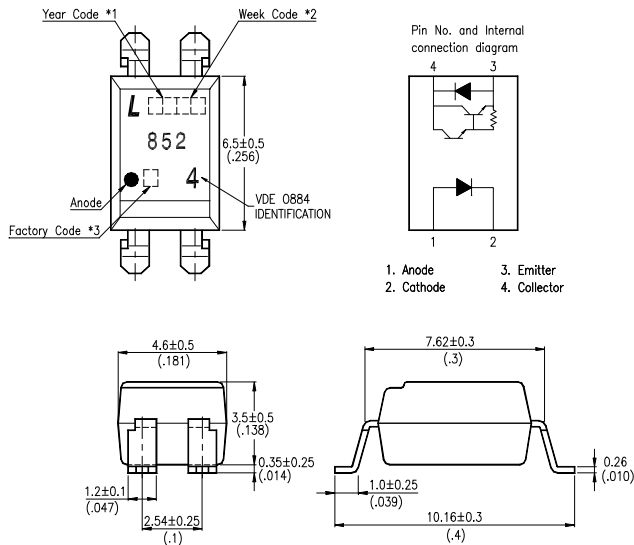

LTV8D52S-V :

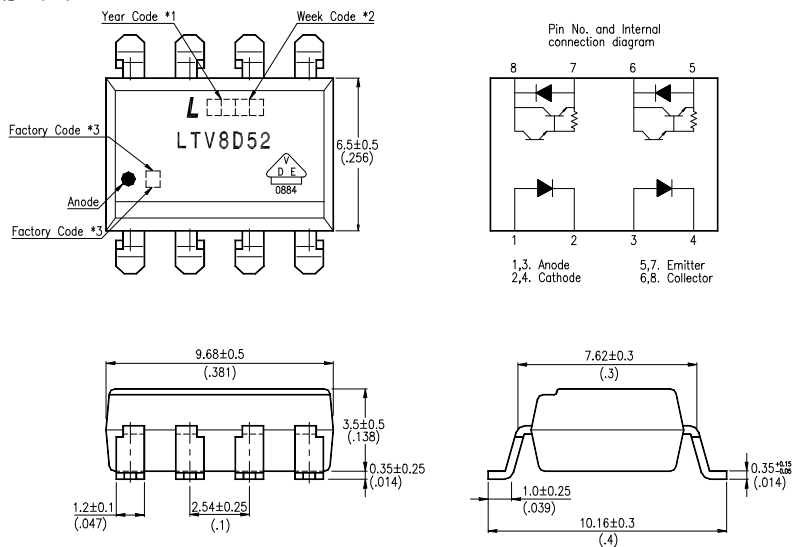

- *1. Year date code.
- *2. 2-digit work week.
- *3. Factory identification mark shall be marked.
(Z : Taiwan, Y : Thailand, X : China-TJ, W : China-CZ)

TAPING DIMENSIONS

LTV852STA1-V :

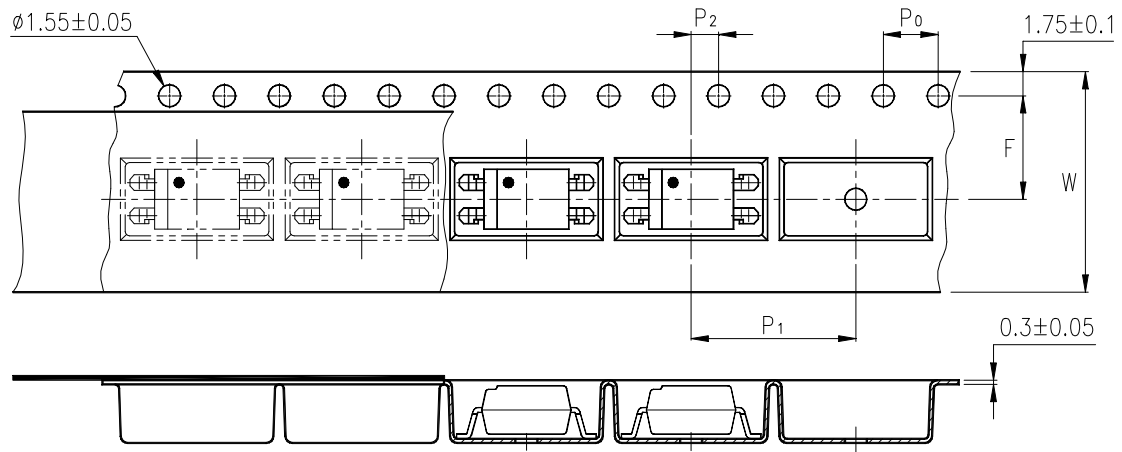

LTV8D52STA1-V :

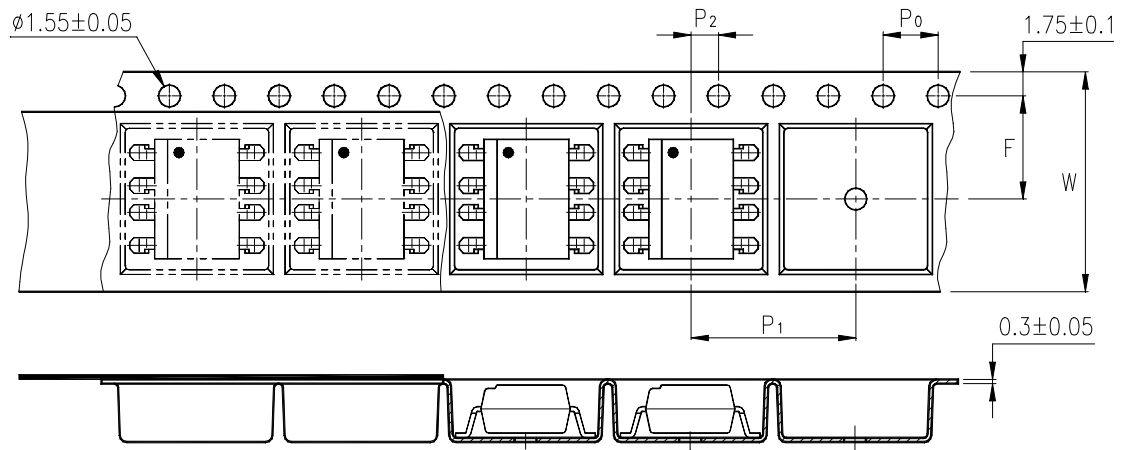

Description	Symbol	Dimensions in mm (inches)
Tape wide	W	16 ± 0.3 (.63)
Pitch of sprocket holes	P_0	4 ± 0.1 (.15)
Distance of compartment	F	7.5 ± 0.1 (.295)
	P_2	2 ± 0.1 (.079)
Distance of compartment to compartment	P_1	12 ± 0.1 (.472)

ABSOLUTE MAXIMUM RATING

(Ta = 25°C)

PARAMETER		SYMBOL	RATING	UNIT
INPUT	Forward Current	I _F	50	mA
	Reverse Voltage	V _R	6	V
	Power Dissipation	P	70	mW
OUTPUT	Collector - Emitter Voltage	V _{CEO}	300	V
	Emitter - Collector Voltage	V _{ECO}	0.1	V
	Collector Current	I _C	150	mA
	Collector Power Dissipation	P _C	150	mW
Total Power Dissipation		P _{tot}	200	mW
*1	Isolation Voltage	V _{iso}	5,000	V _{rms}
Operating Temperature		T _{opr}	-30 ~ +100	°C
Storage Temperature		T _{stg}	-55 ~ +125	°C
*2	Soldering Temperature	T _{sol}	260	°C

*1. AC For 1 Minute, R.H. = 40 ~ 60%

Isolation voltage shall be measured using the following method.

- (1) Short between anode and cathode on the primary side and between collector and emitter on the secondary side.
- (2) The isolation voltage tester with zero-cross circuit shall be used.
- (3) The waveform of applied voltage shall be a sine wave.

*2. For 10 Seconds

ELECTRICAL - OPTICAL CHARACTERISTICS

(Ta = 25°C)

PARAMETER		SYMBOL	MIN.	TYP.	MAX.	UNIT	CONDITIONS
INPUT	Forward Voltage	V _F	—	1.2	1.4	V	I _F =10mA
	Reverse Current	I _R	—	—	10	μA	V _R =4V
	Terminal Capacitance	C _t	—	30	250	pF	V=0, f=1KHz
OUTPUT	Collector Dark Current	I _{CEO}	—	—	200	nA	V _{CE} =200V, I _F =0
	Collector-Emitter Breakdown Voltage	BV _{CEO}	300	—	—	V	I _C =0.1mA I _F =0
	Emitter-Collector Breakdown Voltage	BV _{ECO}	0.1	—	—	V	I _E =10μA I _F =0
TRANSFER CHARACTERISTICS	Collector Current	I _C	10	40	150	mA	I _F =1mA V _{CE} =2V
	*1 Current Transfer Ratio	CTR	1,000	4,000	15,000	%	
	Collector-Emitter Saturation Voltage	V _{CE(sat)}	—	—	1.2	V	I _F =20mA I _C =100mA
	Isolation Resistance	R _{iso}	5×10 ¹⁰	1×10 ¹¹	—	Ω	DC500V 40 ~ 60% R.H.
	Floating Capacitance	C _f	—	0.6	1	pF	V=0, f=1MHz
	Cut-Off Frequency	f _c	1	7	—	kHz	V _{CE} =2V, I _C =20mA R _L =100Ω, -3dB
	Response Time (Rise)	t _r	—	100	300	μs	V _{CC} =2V, I _C =20mA R _L =100Ω
	Response Time (Fall)	t _r	—	20	100	μs	

$$*1 \text{ CTR} = \frac{I_C}{I_F} \times 100\%$$

ISOLATION SPECIFICATION ACCORDING TO VDE 0884

Parameter		Symbol	Conditions	Rating	Unit	Remark
Class of environmental test		-	DIN IEC68	30/100/21	-	
Pollution		-	DIN VDE0110	2	-	
Maximum Operating Isolation Voltage		V_{IORM}	-	850	V_{PEAK}	Refer to the Diagram 1, 2
Partial Discharge Test Voltage (Between Input and Output)	Diagram 1	V_{pr}	$t_p=60s, q_c<5pC$	1275	V_{PEAK}	
	Diagram 2		$t_p=1s, q_c<5pC$	1594	V_{PEAK}	
Maximum Over-voltage		$V_{INITIAL}$	$t_{INI} = 10s$	6000	V_{PEAK}	
Safety Maximum Ratings						
1) Case Temperature		T_{si}	$I_F = 0, P_c = 0$	175	$^{\circ}C$	Refer to the Figure 1, 3
2) Input Current		I_{si}	$P_c=0$	400	mA	
3) Electric Power (Output or Total Power Issipation)		P_{si}	-	700	mW	
Isolation Resistance (Test Voltage Between Input and Output : DC500V)		R_{ISO}	$T_a=T_{si}$	MIN. 10^9	Ω	
			$T_a=T_{opr}(MAX.)$	MIN. 10^{11}		
			$T_a=25^{\circ}C$	MIN. 10^{12}		

Precautions in performing isolation test

* Partial discharge test methods shall be the ones according to the specifications of VDE 0884:1992-06

* Please don't carry out isolation test (V_{iso}) over $V_{INITIAL}$, This product deteriorates isolation characteristics by partial discharge due to applying high voltage (ex. $V_{INITIAL}$). And there is possibility that this product occurs partial discharge in operating isolation voltage (V_{IORM})

PARTIAL DISCHARGE TEST METHOD

Method (A) for type testing and random testing.

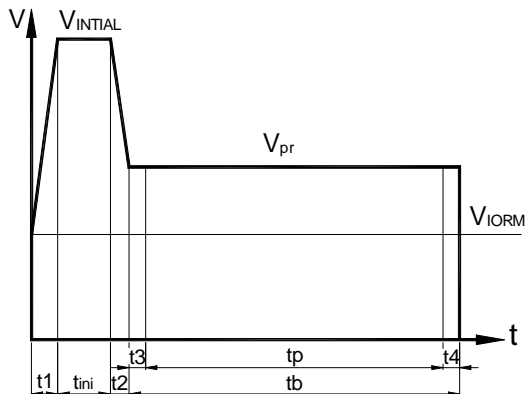

t_1, t_2 = 1 to 10s
 t_3, t_4 = 1s
 t_p (Partial Discharge Measuring Time) = 60s
 t_b = 62s
 t_{ini} = 10s

Method (B) for routine testing.

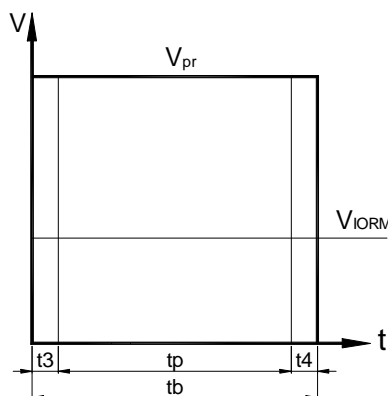

t_3, t_4 = 0.1s
 t_p (Partial Discharge Measuring Time) = 1s
 t_b = 1.2s

The partial discharge level shall not exceed 5 pC during the partial discharge measuring time interval t_p under the test conditions shown above.

CHARACTERISTICS CURVES

Fig.1 Forward Current vs. Ambient Temperature

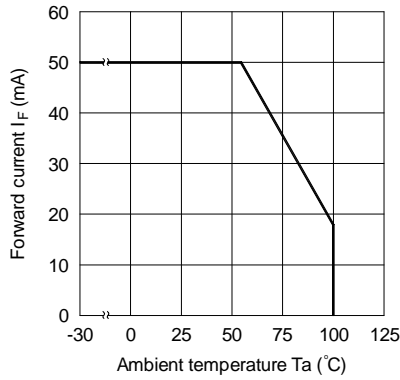

Fig.2 Collector Power Dissipation vs. Ambient Temperature

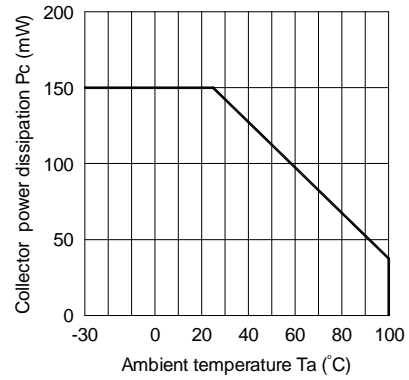

Fig.3 Collector-emitter saturation Voltage vs. Forward current

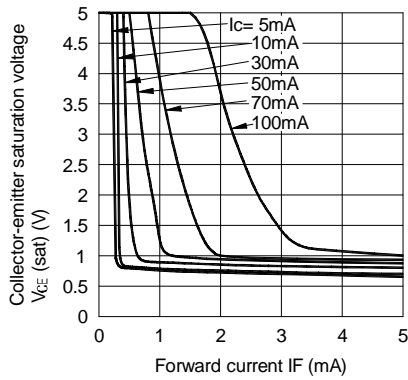

Fig.4 Forward Current vs. Forward Voltage

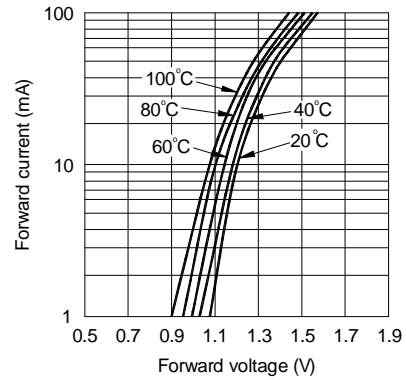

Fig.5 Current Transfer Ratio vs. Forward Current

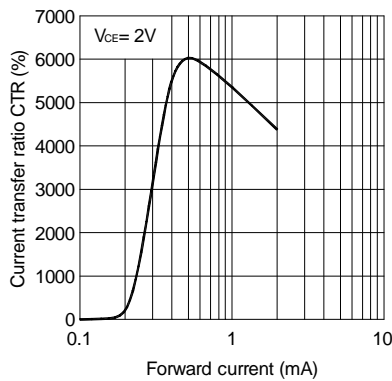
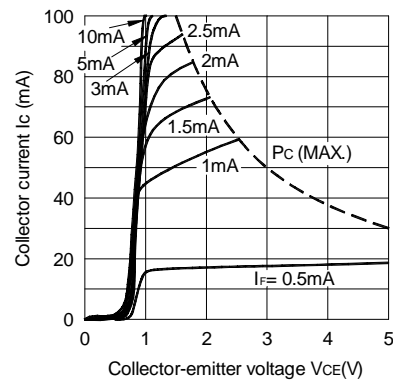

Fig.6 Collector Current vs. Collector-emitter Voltage



CHARACTERISTICS CURVES

Fig.7 Relative Current Transfer Ratio vs. Ambient Temperature

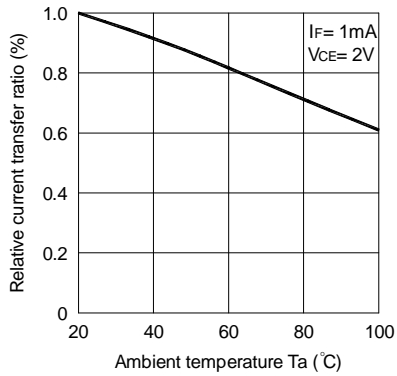

Fig.8 Collector-emitter Saturation Voltage vs. Ambient Temperature

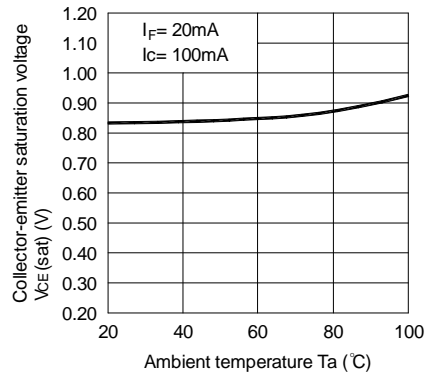

Fig.9 Collector Dark Current vs. Temperature

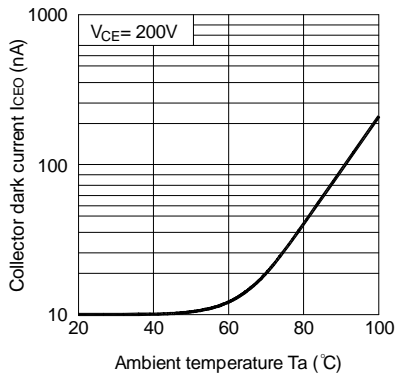

Fig.10 Response Time vs. Load Resistance

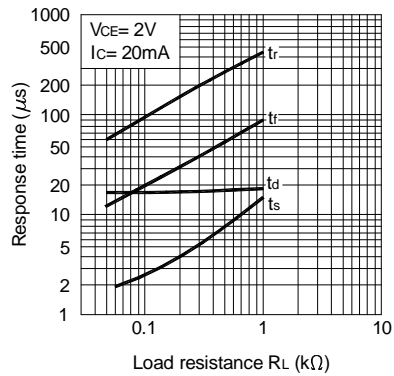
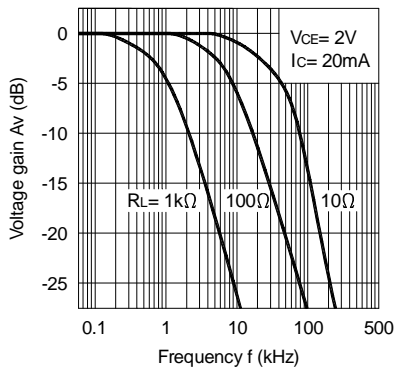
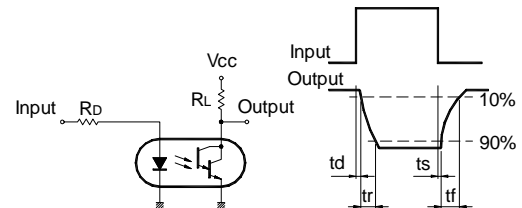

Fig.11 Frequency Response



Test Circuit for Response Time



Test Circuit for Frequency Response

