

TM & TR

Ultra-Miniature Illuminated Pushbutton Switches

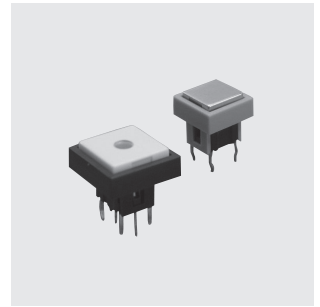

RoHS Compliant

Series

Conductive Rubber Contact (TR type)
Metal Contact (TM type)

Features

1. Two Types of Contacts

TR series: Conductive rubber contact for soft tactile feel.
TM series: Metal contact for sharp tactile feel.

2. PC Board Mount

Terminal pitch is in inches (multiples of 2.54 mm) for all models.

The unique terminal shape prevents the terminal pins from coming loose from the PC board during dip soldering.

3. Enhanced Resistance to Soldering Heat

Improved terminal structure protects the contacts from soldering heat.

In addition, each pole has two terminals which can be used as a jumper wire.

4. Ultra-Miniature Switch with LED

LED is built into miniature housing.

5. Wide Variety of Accessories

A wide variety of accessories are available, including color buttons and mounting frames.

6. Compatible With Lead-Free Soldering (TM Series)

Heat-resistant resin for lead-free soldering.

Specifications

Rating	TR : 10mA 12VDC max. 10 μ A Min.
	TM : 1VA max. (50mA max.48VDC max) 0.5mA min.
	TMG : 1VA Max. (50mA max.48VDC max.) 10 μ A min.
Initial contact resistance	TR : 500 Ω max. (1mA 2VDC at 1.47N {150gf}) TM : 100m Ω max (1.5mA 200 μ VAC at 1.96N {200gf})
Dielectric strength	250VAC 1 minute
Insulation resistance	100M Ω min (100VDC)
Electrical life	TR : 100,000 operations TM : 300,000 operations
Contact Bounce	TR : 3 msec. max. (Initial value) TM : 10 msec. max. (Initial value)
Travel	TR : 1 mm TM : 0.25 mm
Operating force (at peak force)	TR : 0.98 \pm 0.39N TM : 1.37 \pm 0.39N
Operating temperature range	-25~+70°C
Storage temperature range	-40~+70°C

■Part Numbering

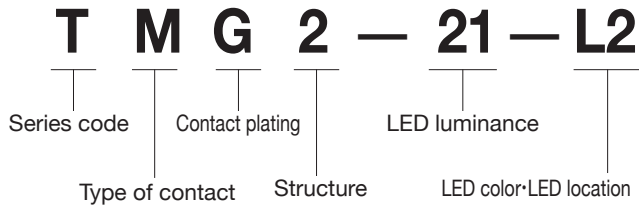

■Type of Contacts and Contact Plating

Code	Type of contact	Contact Plating
R	Conductive rubber contact	Gold plated
M	Metal contact	Silver plated
MG	Metal contact	Gold plated

Note : The contacts of TR series are all gold-plated.

■LED Specifications

TR2—21 • TM2—21

Symbol	Color	Forward Current (I _F)	Forward V (V _F)		Reverse Voltage (V _R)
			nom.	max.	
2	Red	30mA	2.0V	2.5V	DC5V
5	Green	25mA	2.2V	2.5V	DC5V
8	Yellow	30mA	2.1V	2.5V	DC5V

■Operating Force vs. Stroke Characteristics

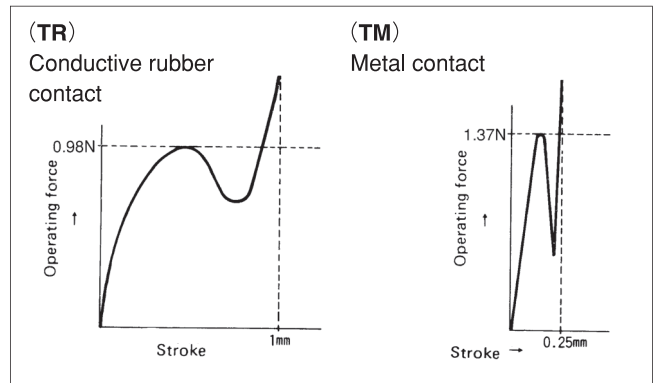





Fig.A

■Structure

Fig.	1	2
Construction	 Without LED	 With LED in button stem

■LED Location

Symbol	※LED location
	TR2 • TM2
L ■	

※When color button is mounted.

TR (Conductive Rubber Contact)

TR1

SPST

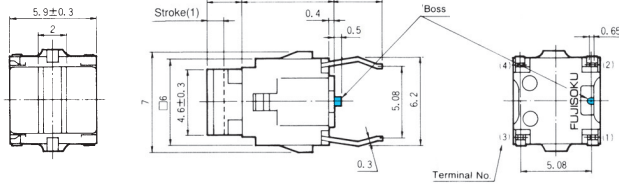
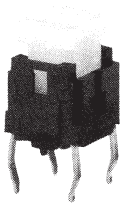

Terminal numbers are not shown on the switch.

Part No.	Switching function		Circuit diagrams
		Push	
TR1-01	OFF	(ON)	
Connecting terminals	—	1 — 3 2 — 4	

TR2

SPST

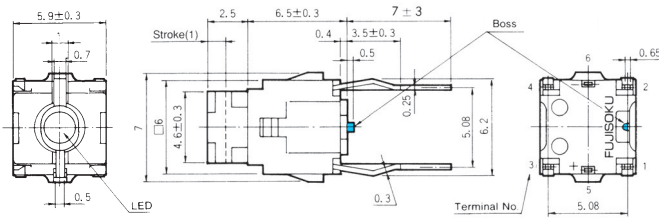
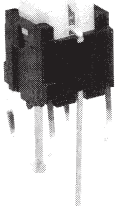

Terminal numbers are not shown on the switch.

Part No.	Switching function		Circuit diagrams
		Push	
TR2-21-L	OFF	(ON)	
Connecting terminals	—	1 — 3 2 — 4	
LED circuit			

TM (Metal Contact)

TM1

SPST

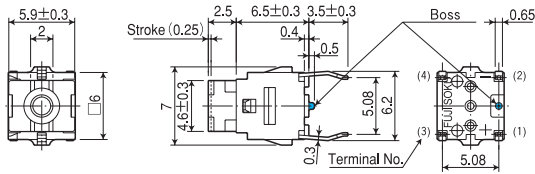

Part No.	Switching function		Circuit diagrams
TM1-01 TMG1-01	OFF	(ON)	
Connecting terminals	—	1 — 3 2 — 4	

Terminal numbers are not shown on the switch.

TM2

SPST

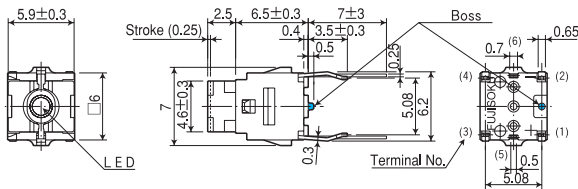

Part No.	Switching function		Circuit diagrams
TM2-21-L ■ TMG2-21-L ■	OFF	(ON)	
Connecting terminals	—	1 — 3 2 — 4	
LED circuit			

Terminal numbers are not shown on the switch.

Mounting Dimension

Part No.	TR1 · TM1 · TMG1 □7.5Button □7.5Mounting Frame	TR1 · TM1 · TMG1 TR2 · TM2 · TMG2 □10Button □10Mounting Frame	TR1 · TM1 · TMG1 □12.6Button □12.6Mounting Frame	TR2 · TM2 · TMG2 □7.5Button □7.5Mounting Frame
Mounting (Top view)				
Button + Switch				
Button + Mounting Frame + Switch				

※▲ : The center of the switch ■ : The center of the button ● : Boss

○ When the switch is used only with the button and without the mounting frame, be sure to give designing consideration to guide the button with the mounting panel, considering rattling, etc.
(Reference: Standard cutout size = Button size + 0.4 ~ 0.5 mm)

Packaging Specifications

Series	TM1 · TMG1 · TR1	TM2 · TR2 · TMG2
Specifications	<p>Stick</p> <p>100 pcs./stick</p> <p>Φ = 630</p>	<p>Zipper Plastic Bag</p> <p>50 pcs./pack</p>

■ Optional Accessories

《Sold Separately》

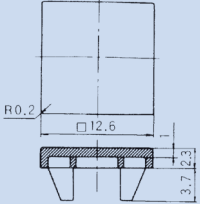
Part Name	<div style="text-align: right;">□ 12.6 Color Button</div> <div style="text-align: center;"> TR1 TM1 </div>
Dimensions	
Dark gray	140000480720
Gray	140000480721
Light gray	140000480722
Ivory	140000480723
Silver	140000480766

■ Optional Accessories

《Sold Separately》

Part Name	□7.5 Color Button		□10 Color Button	
	TR1 • TM1	TR2 • TM2	TR1 • TM1	TR2 • TM2
Dimensions				
Dark gray	140000480712	140007480068	140000480716	140007480117
Gray	140000480713	140007480069	140000480717	140007480118
Light gray	140000480714	140007480070	140000480718	140007480119
Ivory	140000480715	140007480071	140000480719	140007480120
Silver	140000480764	140007480076	140000480765	140007480125
Red	140000480744	140007480072	140000480748	—
Green	140000480746	140007480074	140000480750	—
Blue	140000480745	140007480073	140000480749	—

Part Name	□7.5 Button type Mounting Frame	□10 Button type Mounting Frame	□12.6 Button type Mounting Frame	
	TM1 • TM2 • TR1 • TR2	TM1 • TM2 • TR1 • TR2	TM1	TR1
Dimensions				
Dark gray	140000340143	140000340147	140000340215	140000340151
Gray	140000340144	140000340148	140000340216	140000340152
Light gray	140000340145	140000340149	140000340217	140000340153
Ivory	140000340146	140000340150	140000340218	140000340154

■ Handling Precautions

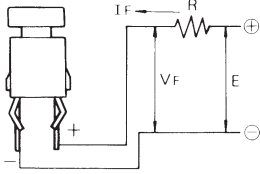
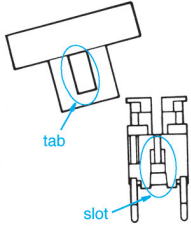
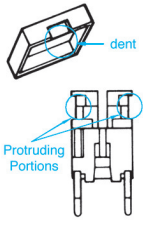
<p>LED circuit</p>	<p>Current to be applied to the LED must be lower than the forward current (IF) indicated in the LED Specifications of each switches. Resistance value R should be calculated using the formula on the right.</p>  <p>Calculation Example : E = 5 V IF = 2.0mA</p> $R = \frac{E - V_F}{I_F} \quad R = \frac{5 - 2.0}{0.02} = 150\Omega$ <p>Use VF=2.0V to calculate.</p>
<p>Accessories mounting</p>	 <p>1. Installing the mounting frame Install the mounting frame so that the tab on the frame is in the same direction as the slot on the switch.</p>  <p>2. Installing the button Install the button so that the recess on the button is in the same direction as the protruding portion on the switch.</p> <p>The mounting frame cannot be installed with the switch button installed.</p>

■ Ambient Conditions

- (1) In case of switches with silver-plated contacts, do not use in an environment where there is corrosive gas such as sulfuric or ammonia gas which may affect the silver plating.
- (2) **TM** and **TR** series are open-structure switches and should not be used in a dusty environment.

■ Soldering Specifications

Series	TM	TR
Manual soldering	380°C Max. 3sec. Max.	380°C Max. 3sec. Max.
Auto soldering	275°C Max. 6sec. Max.	265°C Max. 6sec. Max.

• Preheating in the flow line should be 80°C to 120°C and within 120 seconds.

● Do not dip solder the switches with **color buttons** or **mounting frames** attached.

Soldering heat may deform the accessories or cause ingress of flux.

■ Flux Cleaning

- (1) Solvents : Fluorine or Alcohol type
- (2) The **TM/TR** series are not washable. To wash the PC board, clean the soldering surface of the PC board with a brush so that the switch is not exposed to the cleaning solution.
- (3) After soldering, wait until the temperature of the terminals cool down to 90°C or below or until the parts are exposed to room temperature for more than 5 min. before washing.

Table of Part Numbers

Contact plating		Series		TM1-01	TR1-01	TM2-21		TR2-21
		Silver Plated	Gold Plated	Gold Plated	Silver Plated	Gold Plated	Gold Plated	
LED /Located								
Non-illuminated		TM1-01	TMG1-01	TR1-01	—	—	—	—
Illuminated	LED color/	2 Red	—	—	—	TM2-21-L2	☆ TMG2-21-L2	☆ TR2-21-L2
		5 Green	—	—	—	TM2-21-L5	TMG2-21-L5	TR2-21-L5
		8 Yellow	—	—	—	TM2-21-L8	TMG2-21-L8	☆ TR2-21-L8

● The above part numbers do not include accessories. Buttons and mounting frames need to be ordered separately.