

SSOP-32 to DIP-32 SMT Adapter (0.635 mm pitch, 10.3 x 7.5 mm body)

REF.	DIMENSIONS					
	mm			inches		
	MIN.	TYP.	MAX.	MIN.	TYP.	MAX.
A		7.40				
B		1.90				
C		0.40				
D		0.235				
E		0.635				
F					0.600	
G					0.100	
H					0.025	

Top View (SMT Footprint)

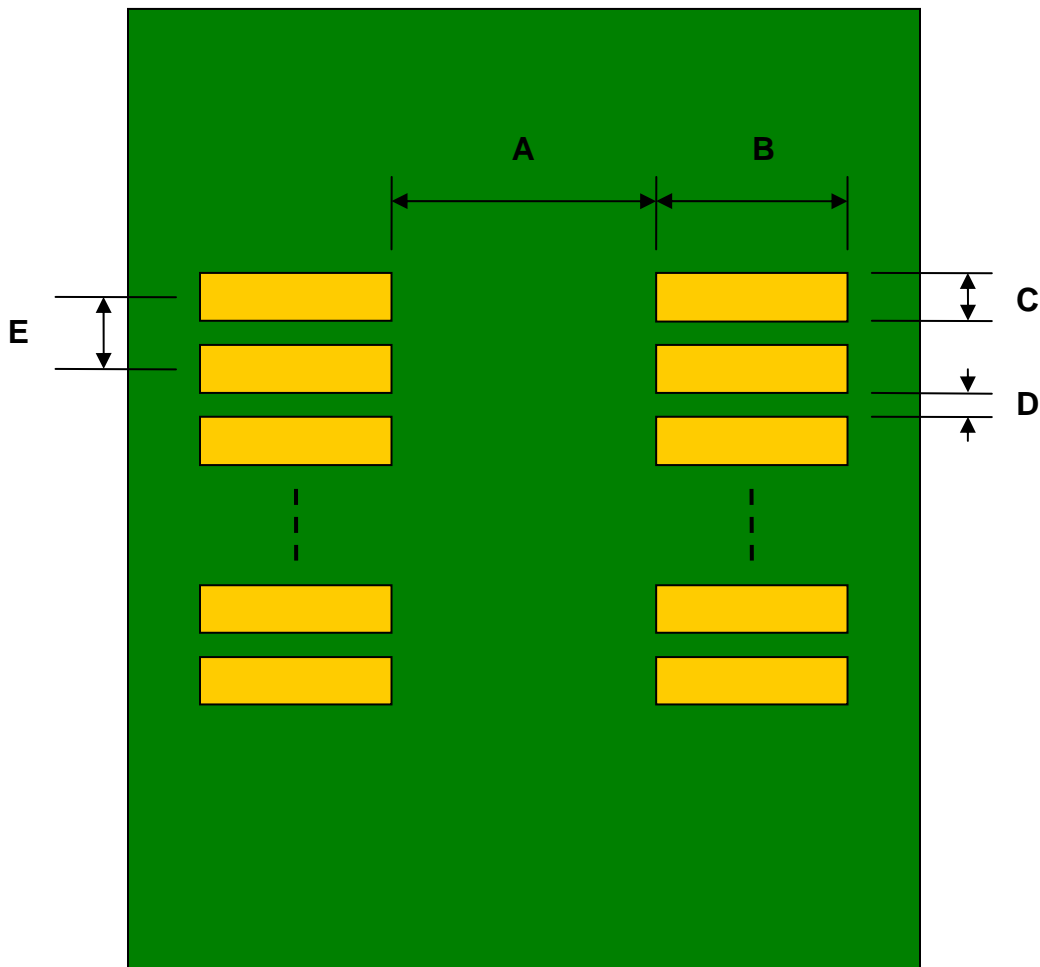

(Representative drawing only - not to scale)

Bottom View (DIP Pins)

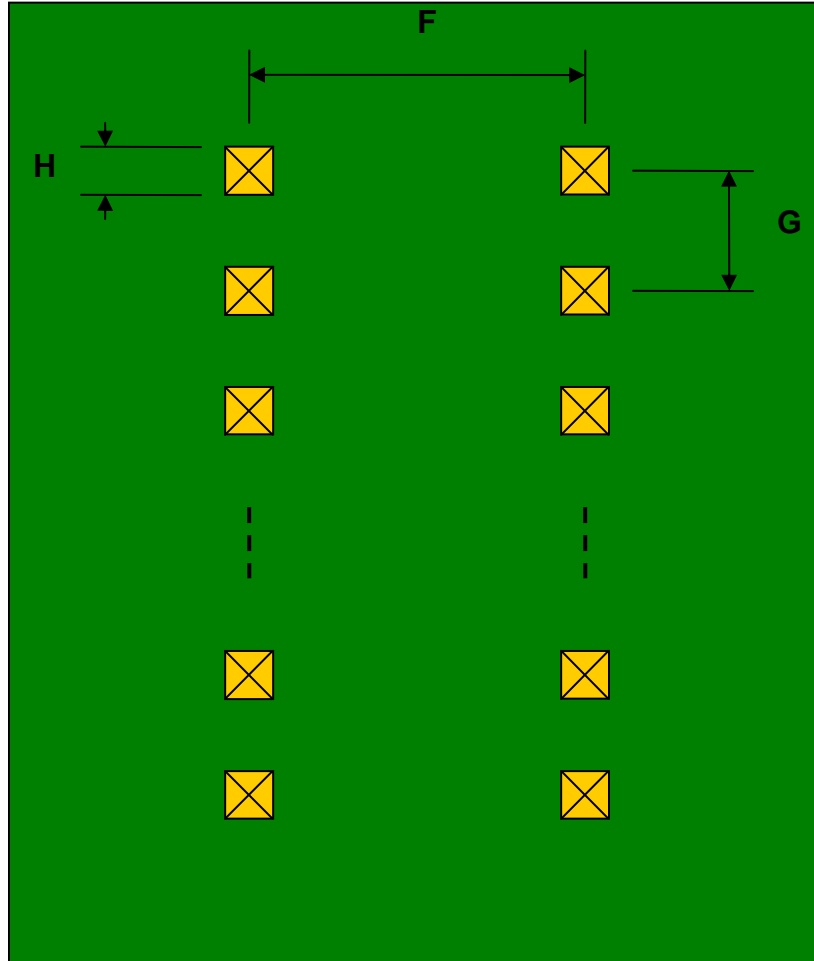

(Representative drawing only - not to scale)

Side View (DIP Pins)

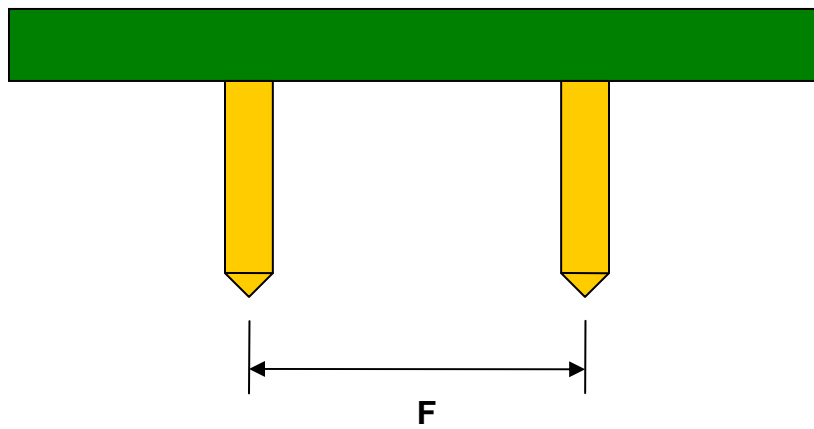

(Representative drawing only - not to scale)