

E2E (E2E-X□D□-U/E2E-X□D□S/E2E-X□Y□/E2E-X□T□)

DC 2-Wire (PUR Cable/Self-diagnosis Output), AC 2-Wire and AC/DC 2-Wire

CSM_E2E_DS_E_13_1

Models with DC 2-Wire (Self-diagnosis Output) and AC 2-Wire added to the lineup

- Detecting ferrous metals.
- Models with different frequencies are also available to prevent mutual interference.
- Superior environment resistance with standard cable made of oil-resistant PVC and sensing surface made of material that resists cutting oil.
- Useful to help prevent disconnection. Cable protector provided as a standard feature.

CE  
 (Standards do not apply to all models.)



 Be sure to read *Safety Precautions* on page 16.

For the most recent information on models that have been certified for safety standards, refer to your OMRON website.

Features

DC 2-Wire

Pre-wired models with oil-resistant reinforced PUR Cable added to the lineup



Oil Resistance (Insulation service life):
 twice or three times
 that of oil-resistant vinyl chloride

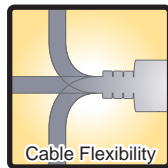

Cable Flexibility:
 approximately twice
 that of vinyl chloride cables

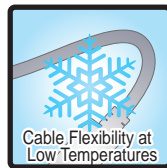

More Flexibility at -40°C

E2E Model Number Legend

E2E- 1 2 3 4 5 6 7 - 8 9 - 10 - 11 12





No.	Classification	Code	Meaning	Remarks
1	Appearance	X	Cylindrical (threaded)	
2	Sensing distance	Number	Sensing distance (Unit: mm)	Example: 1R5: 1.5 mm
		R	Indication of decimal point	
3	Shielding	Blank	Shielded Model	
		M	Unshielded Model	
4	Power supply and output specifications	D	DC 2-wire polarity/no polarity	Whether D models have polarity is defined by number 10.
		T	AC/DC 2-wire	
		Y	AC 2-wire	
5	Form of output switching element	1	Normally open (NO)	
		2	Normally closed (NC)	
6	Oscillation frequency type	Blank	Standard frequency	Used to prevent mutual interference.
		5	Different frequency	
7	Self-diagnosis	Blank	No	
		S	Yes	
8	Connection method	Blank	Pre-wired	
		M1	M12-size metal connector	
9	Connector specifications	Blank	Connector Model AC 2-wire, DC 2-wire with self-diagnosis output, DC 2-wire with old pin arrangement	
		J	Pre-wired Connector Model AC 2-wire, DC 2-wire with old pin arrangement	
		GJ	Pre-wired Connector Model DC 2-wire with IEC pin arrangement	
		TJ	Pre-wired Smartclick Connector Model DC 2-wire	
		TGJ	Pre-wired Smartclick Connector Model DC 2-wire with IEC pin arrangement	
10	DC 2-wire polarity	Blank	Polarity	
		T	No polarity	
11	Cable specifications	Blank	Standard PVC cable (oil resistant)	
		R	Flexible PVC cable (oil resistant)	
		U	Polyurethane cable (oil resistant and reinforced)	
12	Cable length	Letter M	Cable length (Unit: m) (Applicable to Pre-wired Models and Pre-wired Connector Models.)	Example: 2M 0.3M

Note: The purpose of this model number legend is to provide understanding of the meaning of specifications from the model number. Models are not available for all combinations of code numbers.

Ordering Information

DC 2-Wire (No Self-diagnosis Output, PUR Cable models) [Refer to *Dimensions* on page 18.]

Shielded Models 

Appearance	Sensing distance			Connection method	Cable specifications	Polarity	Operation mode	Pin arrangement	Model
M8		2 mm		Pre-wired Models (2 m)	PUR	Yes	NO	---	E2E-X2D1-U 2M
							NC		E2E-X2D2-U 2M
				M12 Pre-wired Smartclick Connector Models (0.3 m)	PUR		NO	1: +V, 4: 0 V	E2E-X2D1-M1TGJ-U 0.3M
							NC	1: +V, 2: 0 V	E2E-X2D2-M1TGJ-U 0.3M
M12		3 mm		Pre-wired Models (2 m)	PUR	Yes	NO	---	E2E-X3D1-U 2M
							NC		E2E-X3D2-U 2M
				M12 Pre-wired Smartclick Connector Models (0.3 m)	PUR		NO	1: +V, 4: 0 V	E2E-X3D1-M1TGJ-U 0.3M
							NC	1: +V, 2: 0 V	E2E-X3D2-M1TGJ-U 0.3M
M18		7 mm		Pre-wired Models (2 m)	PUR	Yes	NO	---	E2E-X7D1-U 2M
							NC		E2E-X7D2-U 2M
				M12 Pre-wired Smartclick Connector Models (0.3 m)	PUR		NO	1: +V, 4: 0 V	E2E-X7D1-M1TGJ-U 0.3M
							NC	1: +V, 2: 0 V	E2E-X7D2-M1TGJ-U 0.3M
M30		10 mm		Pre-wired Models (2 m)	PUR	Yes	NO	---	E2E-X10D1-U 2M
							NC		E2E-X10D2-U 2M
				M12 Pre-wired Smartclick Connector Models (0.3 m)	PUR		NO	1: +V, 4: 0 V	E2E-X10D1-M1TGJ-U 0.3M
							NC	1: +V, 2: 0 V	E2E-X10D2-M1TGJ-U 0.3M

DC 2-Wire (Self-diagnosis Output models) [Refer to Dimensions on page 19.]

Shielded Models 

Appearance	Sensing distance	Connection method	Cable specifications	Polarity	Operation mode	Pin arrangement	Model
M12	3 mm	Pre-wired Models (2 m)	PVC (oil-resistant)	Yes	NO	---	E2E-X3D1S 2M *1
		M12 Connector Models	---			2: +V and diagnostic output 3: 0 V 4: +V and control output	E2E-X3D1S-M1
M18	7 mm	Pre-wired Models (2 m)	PVC (oil-resistant)			---	E2E-X7D1S 2M *1
		M12 Connector Models	---			2: +V and diagnostic output 3: 0 V 4: +V and control output	E2E-X7D1S-M1
M30	10 mm	Pre-wired Models (2 m)	PVC (oil-resistant)			---	E2E-X10D1S 2M *1
		M12 Connector Models	---			2: +V and diagnostic output 3: 0 V 4: +V and control output	E2E-X10D1S-M1

*1. Models with different frequencies are also available. The model number is E2E-X □D15S (example: E2E-X3D15S 2M).

Unshielded Models 

Appearance	Sensing distance	Connection method	Cable specifications	Polarity	Operation mode	Pin arrangement	Model
M12	8 mm	Pre-wired Models (2 m)	PVC (oil-resistant)	Yes	NO	---	E2E-X8MD1S 2M *1
		M12 Connector Models	---			2: +V and diagnostic output 3: 0 V 4: +V and control output	E2E-X8MD1S-M1
M18	14 mm	Pre-wired Models (2 m)	PVC (oil-resistant)			---	E2E-X14MD1S 2M *1
		M12 Connector Models	---			2: +V and diagnostic output 3: 0 V 4: +V and control output	E2E-X14MD1S-M1
M30	20 mm	Pre-wired Models (2 m)	PVC (oil-resistant)			---	E2E-X20MD1S 2M *1
		M12 Connector Models	---			2: +V and diagnostic output 3: 0 V 4: +V and control output	E2E-X20MD1S-M1

*1. Models with different frequencies are also available. The model number is E2E-X □MD15S (example: E2E-X8MD15S 2M).

Connector Pin Assignments of DC 2-Wire Models

- The connector pin assignments of each New E2E DC 2-Wire Model conform to IEC 947-5-2 Table III. (Only DC 2-Wire Models have been changed in comparison to the previous models.)
- The following models with conventional connector pin assignments are available as well. (Only NO Models can be used.)
The cable at the right should also be used if the XW3D-P□55-G11/XW3B-P□55-G11 Connector Junction Box is already being used.

Cable length	Model
500 mm	XS2W-D421-BY1

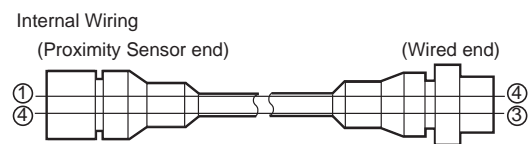

AC 2-Wire [Refer to Dimensions on page 21.]

Shielded Models 

Appearance	Sensing distance	Connection method	Cable specifications	Operation mode	Pin arrangement	Model
M8	1.5 mm	Pre-wired Models (2 m)	PVC (oil-resistant)	NO	---	E2E-X1R5Y1 2M *2
				NC		E2E-X1R5Y2 2M *2
M12	2 mm	Pre-wired Models (2 m)	PVC (oil-resistant)	NO	---	E2E-X2Y1 2M *1
				NC		E2E-X2Y2 2M
		M12 Connector Models	---	NO	(3, 4): (AC, AC)	E2E-X2Y1-M1
				NC	(1, 2): (AC, AC)	E2E-X2Y2-M1
M18	5 mm	Pre-wired Models (2 m)	PVC (oil-resistant)	NO	---	E2E-X5Y1 2M *1
				NC		E2E-X5Y2 2M
		M12 Connector Models	---	NO	(3, 4): (AC, AC)	E2E-X5Y1-M1
				NC	(1, 2): (AC, AC)	E2E-X5Y2-M1
M30	10 mm	Pre-wired Models (2 m)	PVC (oil-resistant)	NO	---	E2E-X10Y1 2M *1
				NC		E2E-X10Y2 2M
		M12 Connector Models	---	NO	(3, 4): (AC, AC)	E2E-X10Y1-M1
				NC	(1, 2): (AC, AC)	E2E-X10Y2-M1

*1. Models with different frequencies are also available. The model number is E2E-X □Y□5 (example: E2E-X5Y15 2M).

*2. Discontinued at the end of March 2022.

Unshielded Models 

Appearance	Sensing distance	Connection method	Cable specifications	Operation mode	Pin arrangement	Model
M8	2 mm	Pre-wired Models (2 m)	PVC (oil-resistant)	NO	---	E2E-X2MY1 2M *2
				NC		E2E-X2MY2 2M *2
M12	5 mm	Pre-wired Models (2 m)	PVC (oil-resistant)	NO	---	E2E-X5MY1 2M *1
				NC		E2E-X5MY2 2M
		M12 Connector Models	---	NO	(3, 4): (AC, AC)	E2E-X5MY1 2M
				NC	(1, 2): (AC, AC)	E2E-X5MY2-M1
M18	10 mm	Pre-wired Models (2 m)	PVC (oil-resistant)	NO	---	E2E-X10MY1 2M *1
				NC		E2E-X10MY2 2M
		M12 Connector Models	---	NO	(3, 4): (AC, AC)	E2E-X10MY1-M1
				NC	(1, 2): (AC, AC)	E2E-X10MY2-M1
M30	18 mm	Pre-wired Models (2 m)	PVC (oil-resistant)	NO	---	E2E-X18MY1 2M *1
				NC		E2E-X18MY2 2M
		M12 Connector Models	---	NO	(3, 4): (AC, AC)	E2E-X18MY1-M1
				NC	(1, 2): (AC, AC)	E2E-X18MY2-M1

*1. Models with different frequencies are also available. The model number is E2E-X □MY□5 (example: E2E-X5MY15 2M).

*2. Discontinued at the end of March 2022.

AC/DC 2-Wire [Refer to Dimensions on page 23.]

Shielded Models 

Appearance	Sensing distance	Connection method	Cable specifications	Operation mode	Pin arrangement	Applicable connector code	Model
M12	3 mm	Pre-wired Models (2 m)	PVC (oil-resistant)	NO	---	---	E2E-X3T1 2M
M18	7 mm	Pre-wired Models (2 m)	PVC (oil-resistant)		---	---	E2E-X7T1 2M
M30	10 mm	Pre-wired Models (2 m)	PVC (oil-resistant)		---	---	E2E-X10T1 2M



Note: There are no unshielded models.

Accessories (Sold Separately)



Sensor I/O Connectors

A Sensor I/O Connector is not provided with the Sensor. It must be ordered separately as required.

Round Water-resistant Connectors XS5 Series

Appearance	Cable Specification	Type	Cable diameter (mm)	Cable Connection Direction	Cable length (m)	Sensor I/O Connector model number	Applicable Proximity Sensor model number
M12 Smartclick Connector Straight type  Right-angle type 	Oil-resistant polyurethane cable	Sockets on One Cable End	6 dia.	Straight	2 m	XS5F-D421-D80-P	E2E-X□D□-M1TGJ-U
					5 m	XS5F-D421-G80-P	
				Right-angle	2 m	XS5F-D422-D80-P	
					5 m	XS5F-D422-G80-P	
		Socket and Plug on Cable Ends		Straight (Socket)/ Straight (Plug)	2 m	XS5W-D421-D81-P	
					5 m	XS5W-D421-G81-P	

Round Water-resistant Connectors XS2 Series

Appearance	Cable Specification	Type	Cable diameter (mm)	Cable Connection Direction	Cable length (m)	Sensor I/O Connector model number	Applicable Proximity Sensor model number	
M12 Screw Connector Straight type  Right-angle type 	Fire-retardant, PVC Robot Cable	Sockets on One Cable End	6 dia.	Straight	2 m	XS2F-D421-D80-F	E2E-X□D□S-M1	
					5 m	XS2F-D421-G80-F		
		Right-angle		Socket and Plug on Cable Ends	Straight (Socket)/ Straight (Plug)	2 m		XS2W-D421-D81-F
						5 m		XS2W-D421-G81-F
	Fire-retardant, PVC Robot Cable	Sockets on One Cable End		6 dia.	Straight	2 m	XS2F-A421-DB0-F	E2E-X□Y1-M1
						5 m	XS2F-A421-GB0-F	
Right-angle			2 m		XS2F-A422-DB0-F			
			5 m		XS2F-A422-GB0-F			
Fire-retardant, PVC Robot Cable	Sockets on One Cable End	6 dia.	Straight	2 m	XS2F-A421-D90-F	E2E-X□Y2-M1		
				5 m	XS2F-A421-G90-F			

Note: For details, refer to *Sensor I/O Connectors/Sensor Controllers* on your OMRON website.

Ratings and Specifications

DC 2-Wire (E2E-X□D□)

Item	Size Shielded Model	M8		M12		M18		M30	
		Shielded	Shielded	Shielded	Unshielded	Shielded	Unshielded	Shielded	Unshielded
		E2E-X2D□	E2E-X3D□	E2E-X8MD□	E2E-X7D□	E2E-X14MD□	E2E-X10D□	E2E-X20MD□	
Sensing distance		2 mm ±10%	3 mm ±10%	8 mm ±10%	7 mm ±10%	14 mm ±10%	10 mm ±10%	20 mm ±10%	
Set distance *1		0 to 1.6 mm	0 to 2.4 mm	0 to 6.4 mm	0 to 5.6 mm	0 to 11.2 mm	0 to 8 mm	0 to 16 mm	
Differential travel		15% max. of sensing distance	10% max. of sensing distance						
Detectable object		Ferrous metal (The sensing distance decreases with non-ferrous metal. Refer to <i>Engineering Data</i> on pages 10 and 11.							
Standard sensing object		Iron, 8 × 8 × 1 mm	Iron, 12 × 12 × 1 mm	Iron, 30 × 30 × 1 mm	Iron, 18 × 18 × 1 mm	Iron, 30 × 30 × 1 mm		Iron, 54 × 54 × 1 mm	
Response frequency *2		1.5 kHz	1 kHz	0.8 kHz	0.5 kHz	0.4 kHz		0.1 kHz	
Power supply voltage (operating voltage range)		12 to 24 VDC, ripple (p-p): 10% max. (10 to 30 VDC)							
Leakage current		0.8 mA max.							
Control output	Load current	3 to 100 mA, Diagnostic output: 50 mA for -D1(5)S Models							
	Residual voltage	3 V max. (Load current: 100 mA, Cable length: 2 m)							
Indicators		D1 Models: Operation indicator (red) and setting indicator (green) D2 Models: Operation indicator (red)							
Operation mode (with sensing object approaching)		D1 Models: NO Refer to the timing charts under <i>I/O Circuit Diagrams</i> on page 13 for details. D2 Models: NC							
Diagnostic output delay		0.3 to 1 s							
Protection circuits		Surge suppressor, Load short-circuit protection (for control and diagnostic output)							
Ambient temperature range		Operating: -25 to 70°C, Storage: -40 to 85°C (with no icing or condensation)							
Ambient humidity range		Operating/storage: 35% to 95% (with no condensation)							
Temperature influence		±15% max. of sensing distance at 23°C in the temperature range of -25 to 70°C		±10% max. of sensing distance at 23°C in the temperature range of -25 to 70°C					
Voltage influence		±1% max. of sensing distance at rated voltage in the rated voltage ±15% range							
Insulation resistance		50 MΩ min. (at 500 VDC) between current-carrying parts and case							
Dielectric strength		1000 VAC, 50/60 Hz for 1 minute between current carry parts and case							
Vibration resistance		Destruction: 10 to 55 Hz, 1.5-mm double amplitude for 2 hours each in X, Y, and Z directions							
Shock resistance		Destruction: 500 m/s ² 10 times each in X, Y, and Z directions		Destruction: 1,000 m/s ² 10 times each in X, Y, and Z directions					
Degree of protection		Pre-wired Models: IEC 60529 IP67, in-house standards: oil-resistant Connector Models: IEC 60529 IP67							
Connection method		Pre-wired Models (Standard cable length: 2 m), Connector Models, or Pre-wired Connector Models (Standard cable length: 0.3 m)							
Weight (packed state)	Pre-wired Models	Approx. 60 g	Approx. 70 g		Approx. 130 g		Approx. 175 g		
	Pre-wired Connector Models	---	Approx. 40 g (Shielded Models only)		---		---		
	Connector Models	Approx. 15 g	Approx. 25 g		Approx. 40 g		Approx. 90 g		
Materials	Case	Stainless steel (SUS303)		Nickel-plated brass					
	Sensing surface	PBT							
	Clamping nuts	Nickel-plated brass							
	Toothed washer	Zinc-plated iron							
Accessories		Instruction manual							

*1. Use the E2E within the range in which the setting indicator (green LED) is ON (except D2 Models).

*2. The response frequency is an average value.

Measurement conditions are as follows: standard sensing object, a distance of twice the standard sensing object, and a set distance of half the sensing distance.

AC 2-Wire (E2E-X□Y□)

Item	Size		M8		M12		M18		M30		
	Shielded Model	Unshielded Model	Shielded	Unshielded	Shielded	Unshielded	Shielded	Unshielded	Shielded	Unshielded	
			E2E-X1R5Y□	E2E-X2MY□	E2E-X2Y□	E2E-X5MY□	E2E-X5Y□	E2E-X10MY□	E2E-X10Y□	E2E-X18MY□	
Sensing distance	1.5 mm ±10%		2 mm ±10%		5 mm ±10%		10 mm ±10%		18 mm ±10%		
Set distance	0 to 1.2 mm		0 to 1.6 mm		0 to 4 mm		0 to 8 mm		0 to 14 mm		
Differential travel	10% max. of sensing distance										
Detectable object	Ferrous metal (The sensing distance decreases with non-ferrous metal. Refer to <i>Engineering Data</i> on page 11.)										
Standard sensing object	Iron, 8 × 8 × 1 mm		Iron, 12 × 12 × 1 mm			Iron, 15 × 15 × 1 mm		Iron, 18 × 18 × 1 mm		Iron, 30 × 30 × 1 mm	
Response frequency	25 Hz										
Power supply voltage (operating voltage range)^{*1}	24 to 240 VAC (20 to 264 VAC), 50/60 Hz										
Leakage current	1.7 mA max.										
Control output	Load current^{*2}	5 to 100 mA			5 to 200 mA			5 to 300 mA			
	Residual voltage	Refer to <i>Engineering Data</i> on page 12.									
Indicators	Operation indicator (red)										
Operation mode (with sensing object approaching)	Y1 Models: NO Y2 Models: NC Refer to the timing charts under <i>I/O Circuit Diagrams</i> on page 14 for details.										
Protection circuits	Surge suppressor										
Ambient temperature range^{*1*2}	Operating/Storage: -25 to 70°C (with no icing or condensation)				Operating/Storage: -40 to 85°C (with no icing or condensation)						
Ambient humidity range	Operating/storage: 35% to 95% (with no condensation)										
Temperature influence	±10% max. of sensing distance at 23°C in the temperature range of -25 to 70°C				±15% max. of sensing distance at 23°C in the temperature range of -40 to 85°C, ±10% max. of sensing distance at 23°C in the temperature range of -25 to 70°C						
Voltage influence	±1% max. of sensing distance at rated voltage in the rated voltage ±15% range										
Insulation resistance	50 MΩ min. (at 500 VDC) between current-carrying parts and case										
Dielectric strength	4,000 VAC (M8 Models: 2,000 VAC), 50/60 Hz for 1 min between current-carrying parts and case										
Vibration resistance	Destruction: 10 to 55 Hz, 1.5-mm double amplitude for 2 hours each in X, Y, and Z directions										
Shock resistance	Destruction: 500 m/s ² 10 times each in X, Y, and Z directions				Destruction: 1,000 m/s ² 10 times each in X, Y, and Z directions						
Degree of protection	Pre-wired Models: IEC 60529 IP67, in-house standards: oil-resistant Connector Models: IEC 60529 IP67										
Connection method	Pre-wired Models (Standard cable length: 2 m) and Connector Models										
Weight (packed state)	Pre-wired Models Model	Approx. 60 g			Approx. 70 g			Approx. 130 g		Approx. 175 g	
	Connector Models	Approx. 15 g			Approx. 25 g			Approx. 40 g		Approx. 90 g	
Materials	Case	Stainless steel (SUS303)			Nickel-plated brass						
	Sensing surface	PBT									
	Clamping nuts	Nickel-plated brass									
	Toothed washer	Zinc-plated iron									
Accessories	Instruction manual										

*1. When supplying 24 VAC to any of the above models, make sure that the operating ambient temperature range is at least -25°C.

*2. When using an M18 or M30 Connector Model at an ambient temperature between 70 and 85°C, make sure that the Sensor has a control output (load current) of 5 to 200 mA max.

AC/DC 2-Wire (E2E-X□T1)

Item	Size Shielded Model	M12	M18	M30
		Shielded		
		E2E-X3T1	E2E-X7T1	E2E-X10T1
Sensing distance		3 mm ±10%	7 mm ±10%	10 mm ±10%
Set distance		0 to 2.4 mm	0 to 5.6 mm	0 to 8 mm
Differential travel		10% max. of sensing distance		
Detectable object		Ferrous metal (The sensing distance decreases with non-ferrous metal. Refer to <i>Engineering Data</i> on page 10.)		
Standard sensing object		Iron, 12 × 12 × 1 mm	Iron, 18 × 18 × 1 mm	Iron, 30 × 30 × 1 mm
Response frequency *1	DC	1 kHz	0.5 kHz	0.4 kHz
	AC	25 Hz		
Power supply voltage (operating voltage range) *2		24 to 240 VDC (20 to 264 VDC) 48 to 240 VAC (40 to 264 VAC)		
Leakage current		DC: 1 mA max. AC: 2 mA max.		
Control output	Load current	5 to 100 mA		
	Residual voltage	DC: 6 V max. (Load current: 100 mA, Cable length: 2 m) AC: 10 V max. (Load current: 5 mA, Cable length: 2 m)		
Indicators		Operation indicator (red), Setting indicator (green)		
Operation mode (with sensing object approaching)		NO (Refer to the timing charts under <i>I/O Circuit Diagrams</i> on page 14 for details.)		
Protection circuits		Load short-circuit protection (20 to 40 VDC only), Surge suppressor		
Ambient temperature range		Operating: -25 to 70°C, Storage: -40 to 85°C (with no icing or condensation)		
Ambient humidity range		Operating/Storage: 35% to 95% (with no condensation)		
Temperature influence		±10% max. of sensing distance at 23°C in the temperature range of -25 to 70°C		
Voltage influence		±1% max. of sensing distance at rated voltage in the rated voltage ±15% range		
Insulation resistance		50 MΩ min. (at 500 VDC) between current-carrying parts and case		
Dielectric strength		4,000 VAC, 50/60 Hz for 1 minute between current-carrying parts and case		
Vibration resistance		Destruction: 10 to 55 Hz, 1.5-mm double amplitude for 2 hours each in X, Y, and Z directions		
Shock resistance		Destruction: 1,000 m/s ² 10 times each in X, Y, and Z directions		
Degree of protection		IEC 60529 IP67, in-house standards: oil-resistant		
Connection method		Pre-wired Models (Standard cable length: 2 m)		
Weight (packed state)		Approx. 80 g	Approx. 140 g	Approx. 190 g
Materials	Case	Nickel-plated brass		
	Sensing surface	PBT		
	Clamping nuts	Nickel-plated brass		
	Toothed washer	Zinc-plated iron		
Accessories		Instruction manual		

*1. The response frequency is an average value. Measurement conditions are as follows: standard sensing object, a distance of twice the standard sensing object, and a set distance of half the sensing distance.

*2. Power Supply Voltage Waveform:

Use a sine wave for the power supply. Using a rectangular AC power supply may result in faulty reset.

Engineering Data (Reference Value)

Sensing Area

Shielded Models

E2E-X□D□/-X□T1

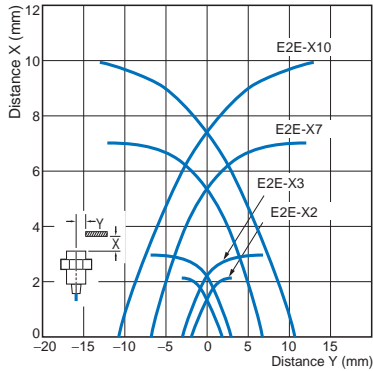

E2E-X□Y□

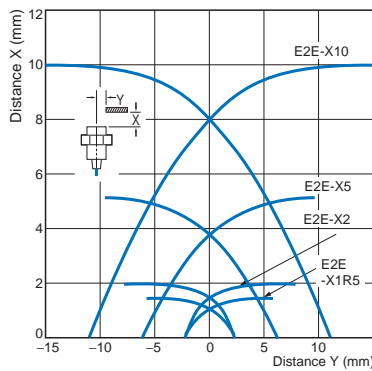

Unshielded Models

E2E-X□MD□

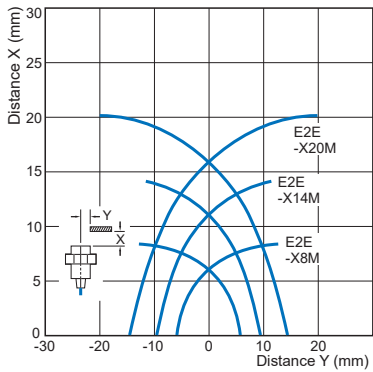

E2E-X□MY□

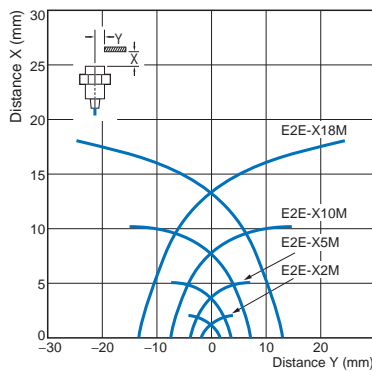

Influence of Sensing Object Size and Material

E2E-X2D□

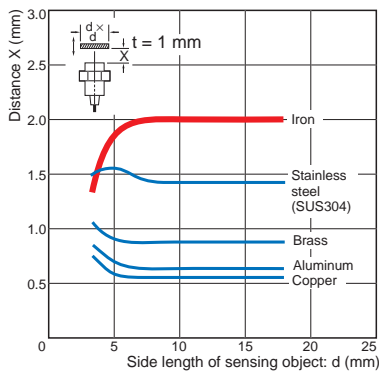

E2E-X3D□/-X3T1

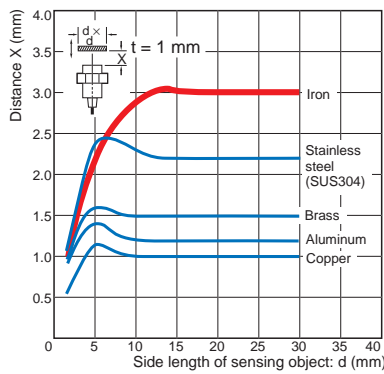

E2E-X7D□/-X7T1

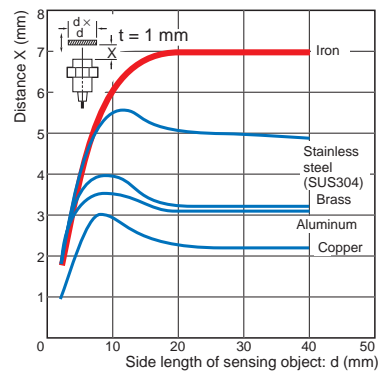

E2E-X10D□/-X10T1

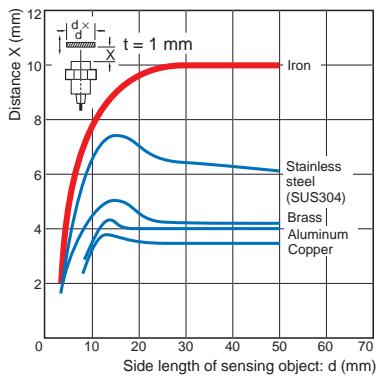

E2E-X8MD□

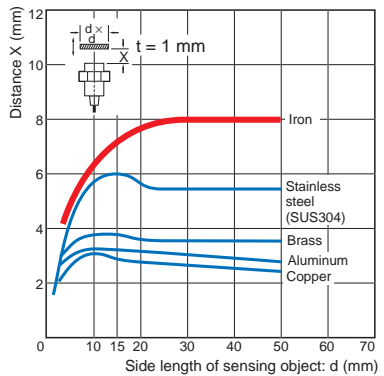

E2E-X14MD□

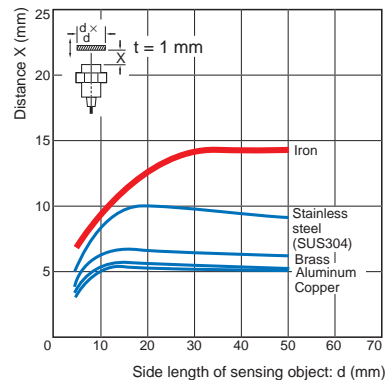

E2E-X20MD

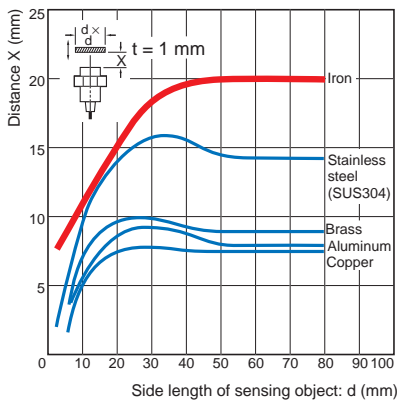

E2E-X1R5Y

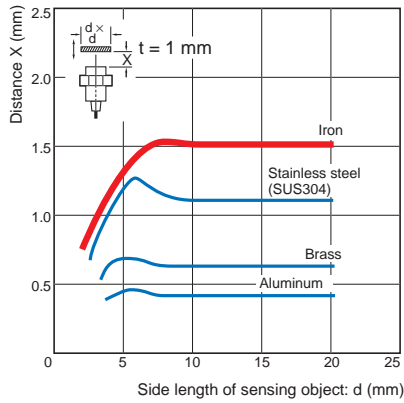

E2E-X2Y

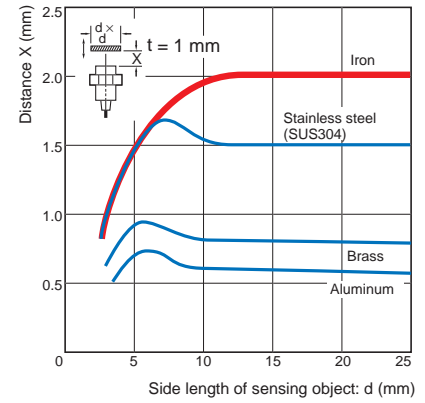

E2E-X5Y

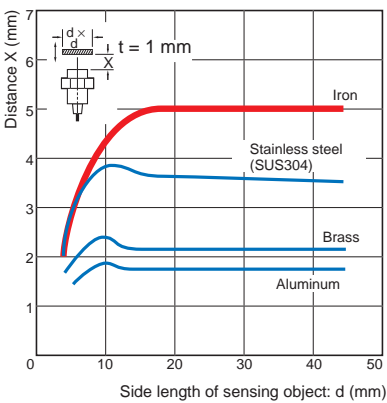

E2E-X10Y

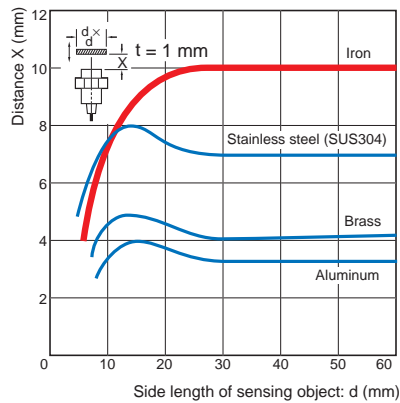

E2E-X2MY

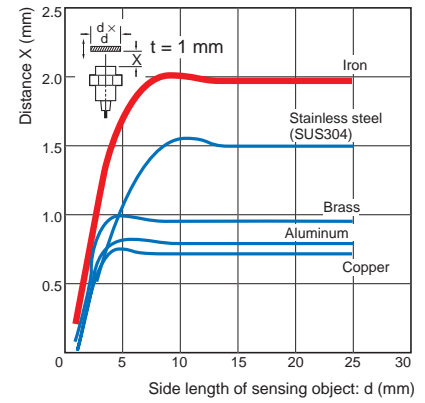

E2E-X5MY

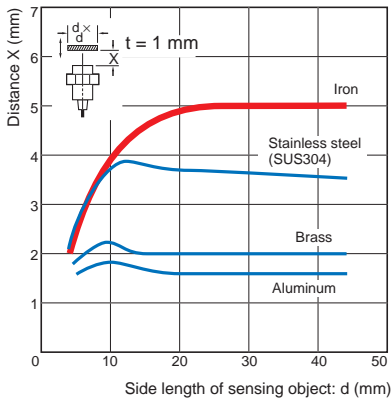

E2E-X10MY

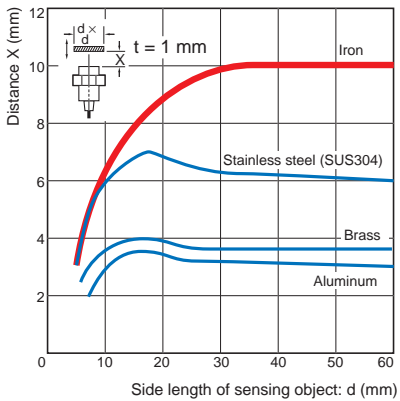

E2E-X18MY

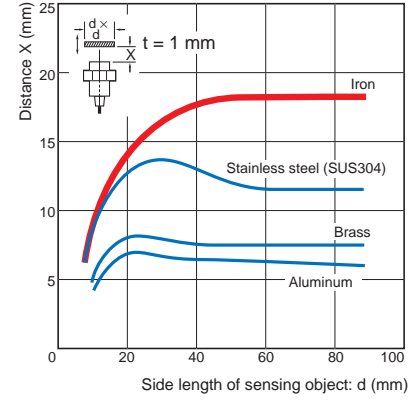

Leakage Current

E2E-X□D□

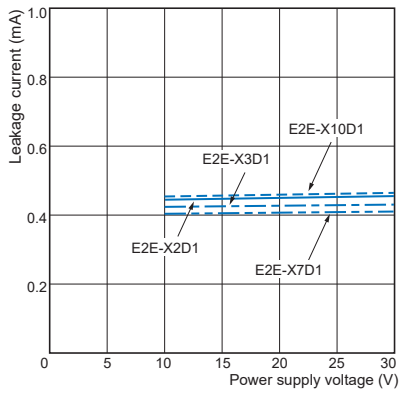

E2E-X□Y□

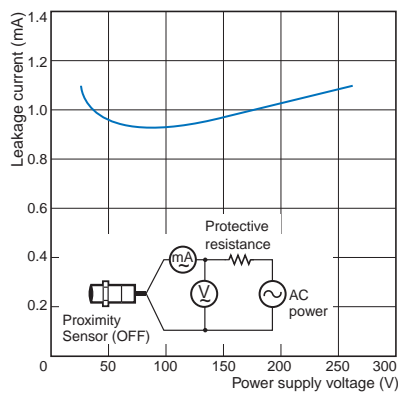

E2E-X□T1

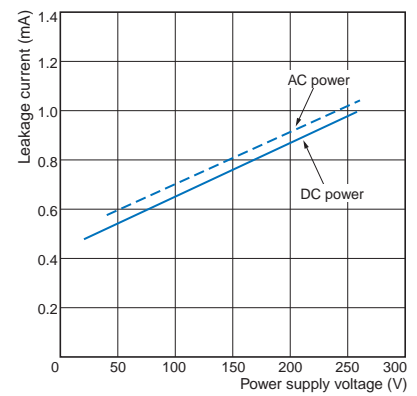

Residual Output Voltage

E2E-X□D□

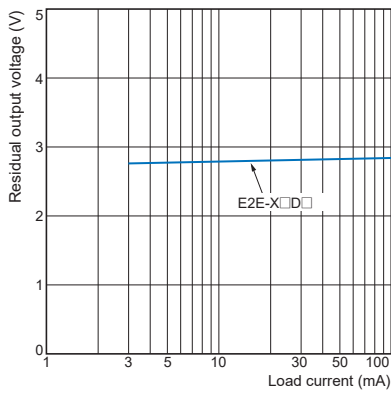

E2E-X□T1

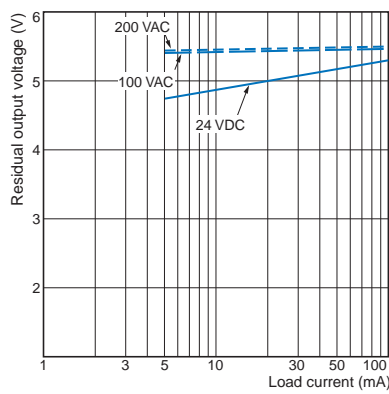

E2E-X□Y□ at 24 VAC

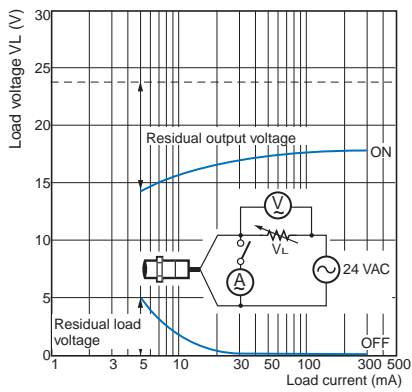

E2E-X□Y□ at 100 VAC

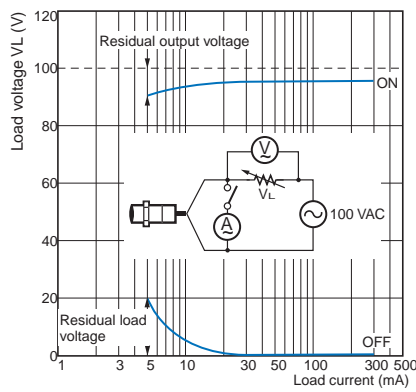

E2E-X□Y□ at 200 VAC

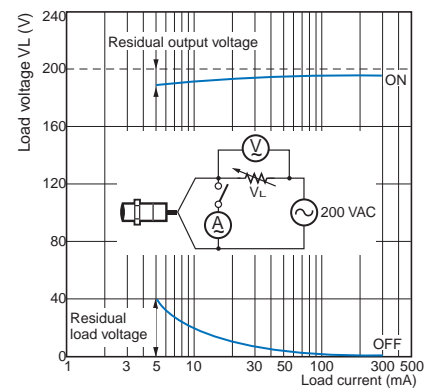

I/O Circuit Diagrams

DC 2-Wire

Operation mode	Model	Timing Chart	Output circuit
<p>Without self-diagnostic output: NO</p>	<p>E2E-X□D1(-M1TGJ)-U</p>		<p>Note: The load can be connected to either the +V or 0 V side.</p>
<p>Without self-diagnostic output: NC</p>	<p>E2E-X□D2(-M1TGJ)-U</p>		<p>Note: The load can be connected to either the +V or 0 V side.</p>
<p>With self-diagnostic output: NO</p>	<p>E2E-X□D1S E2E-X□D1S-M1</p>	<p>* The diagnostic output is ON when there is a coil burnout or the sensing object is located in the unstable sensing area for 0.3 s or longer.</p>	<p>Note: Connect both the loads to the +V side of the control output and diagnostic output.</p>

AC 2-Wire

Operation mode	Model	Timing Chart	Output circuit
NO	E2E-X□Y□ E2E-X□Y□-M1		<p>Note: For Connector Models, the connection between pins 3 and 4 uses an NO contact, and the connection between pins 1 and 2 uses an NC contact.</p>
NC			

AC/DC 2-Wire

Operation mode	Model	Timing Chart	Output circuit
NO	E2E-X□T1		<p>Note: The load can be connected to either the +V or 0 V side. There is no need to be concerned about the polarity (brown/blue) of the Proximity Sensor.</p>

Connections for Sensor I/O Connectors

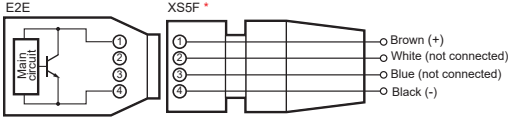
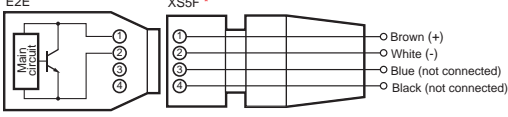
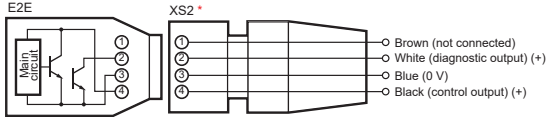
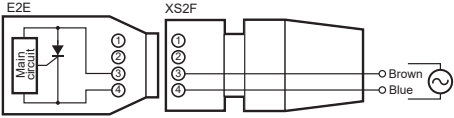
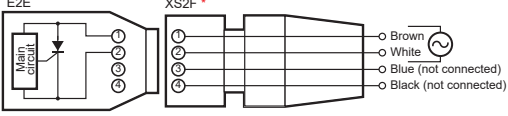
Proximity Sensor				Sensor I/O Connector Model	Connections
Type	Polarity	Operation mode	Model		
DC 2-Wire (M12 Smartclick Connector)	Yes	NO	E2E-X□D1-M1TGJ-U	XS5F-D421-□80-P XS5F-D422-□80-P XS5W-D421-□81-P	
	Yes	NC	E2E-X□D2-M1TGJ-U		
DC 2-Wire (M12 Screw Connector)	Yes	NO	E2E-X□D1S-M1	XS2F-D421-□80-F XS2F-D422-□80-F XS2W-D421-□81-F	
	---	NO	E2E-X□Y1-M1	XS2F-A421-□B0-F XS2F-A422-□B0-F	
	---	NC	E2E-X□Y2-M1	XS2F-A421-□90-F	

* Different from Proximity Sensor wire colors.

Note: For details, refer to Sensor I/O Connectors/Sensor Controllers on your OMRON website.

Safety Precautions

Refer to *Warranty and Limitations of Liability*.

⚠ WARNING

This product is not designed or rated for ensuring safety of persons either directly or indirectly. Do not use it for such purposes.



⚠ CAUTION

- Do not short the load. Explosion or burning may result.
- Do not supply power to the Sensor with no load, otherwise Sensor may be damaged.



Precautions for Correct Use

Do not use this product under ambient conditions that exceed the ratings.

● Design

Influence of Surrounding Metal

When mounting the Sensor within a metal panel, ensure that the clearances given in the following table are maintained. Failure to maintain these distances may cause deterioration in the performance of the Sensor.

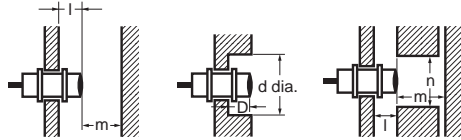

Influence of Surrounding Metal

(Unit: mm)

Model	Item	M8	M12	M18	M30	
DC 2-wire E2E-X□D□	l	0				
	d	8	12	18	30	
	D	0				
	m	4.5	8	20	40	
	n	12	18	27	45	
AC/DC 2-wire E2E-X□T1	l	15				
	d	40				
	D	---	15	22	30	
	m	20				
	n	40				
AC 2-wire E2E-X□Y□	l	0				
	d	8	12	18	30	
	D	0				
	m	4.5	8	20	40	
	n	12	18	27	45	
	Unshielded	l	6	15	22	30
		d	24	40	55	90
		D	6	15	22	30
		m	8	20	40	70
		n	24	36	54	90

Relationship between Sizes and Models

Model	Model	
M8	Shielded	E2E-X2D□ E2E-X1R5Y□
	Unshielded	E2E-X2MY□
M12	Shielded	E2E-X3D□ E2E-X2Y□ E2E-X3T1
	Unshielded	E2E-X8MD□ E2E-X5MY□
M18	Shielded	E2E-X7D□ E2E-X5Y□ E2E-X7T1
	Unshielded	E2E-X14MD□ E2E-X10MY□
M30	Shielded	E2E-X10D□ E2E-X10Y□ E2E-X10T1
	Unshielded	E2E-X20MD□ E2E-X18MY□

Mutual Interference

When installing Sensors face-to-face or side-by-side, ensure that the minimum distances given in the following table are maintained.

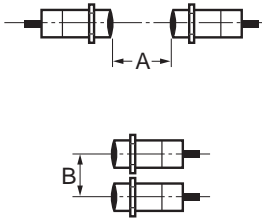

Mutual Interference

(Unit: mm)

Model	Item	M8	M12	M18	M30	
DC 2-wire E2E-X□D□	Shielded	A	20	30 (20)	50 (30)	100 (50)
		B	15	20 (12) *	35 (18) *	70 (35)
AC/DC 2-wire E2E-X□T1	Unshielded	A	80	120 (60)	200 (100)	300 (100)
		B	60	100 (50)	110 (60)	200 (100)
AC 2-wire E2E-X□Y□	Shielded	A	20	30 (20)	50 (30)	100 (50)
		B	15	20 (12) *	35 (18) *	70 (35)
	Unshielded	A	80	120 (60)	200 (100)	300 (100)
		B	60	100 (50)	110 (60)	200 (100)

Note: Values in parentheses apply to Sensors operating at different frequencies.
 * Mutual interference will not occur for close-proximity mounting if models with different frequencies are used together.

Loads with Large Surge Currents (E2E-X□T□)

If a load with a large surge current is connected, such as a relay, lamp, or motor, the surge current may cause the load short-circuit protection circuit to operate, resulting in operating errors.

● Mounting

Tightening Force

Do not tighten the nut with excessive force. A washer must be used with the nut.

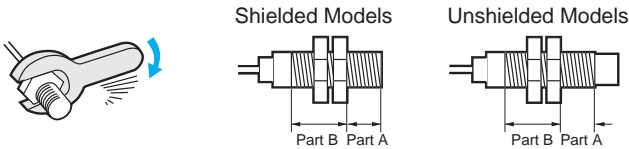

Note: 1. The allowable tightening strength depends on the distance from the edge of the head, as shown in the following table. (A is the distance from the edge of the head. B includes the nut on the head side. If the edge of the nut is in part A, the tightening torque for part A applies instead.)
 2. The following strengths assume washers are being used.

Model		Part A		Part B
		Dimension	Torque	Torque
M8	Shielded	9	9 N·m	12 N·m
	Unshielded	3		
M12			30 N·m	
M18			70 N·m	
M30			180 N·m	

Connecting a DC 2-Wire Proximity Sensor to a PLC (Programmable Controller)

Required Conditions

Connection to a PLC is possible if the specifications of the PLC and the Proximity Sensor satisfy the following conditions. (The meanings of the symbols are given at the right.)

1. The ON voltage of the PLC and the residual voltage of the Proximity Sensor must satisfy the following.

$$V_{ON} \leq V_{CC} - V_R$$

2. The OFF current of the PLC and the leakage current of the Proximity Sensor must satisfy the following.

$$I_{OFF} \geq I_{leak}$$

(If the OFF current is not listed in the PLC's input specifications, take it to be 1.3 mA.)

3. The ON current of the PLC and the control output of the Proximity Sensor must satisfy the following.

$$I_{OUT} (min.) \leq I_{ON} \leq I_{OUT} (max.)$$

The ON current of the PLC will vary, however, with the power supply voltage and the input impedance, as shown in the following equation.

$$I_{ON} = (V_{CC} - V_R - V_{PC}) / R_{IN}$$

Example

In this example, the above conditions are checked when the Proximity Sensor is the E2E-X7D1-U and the power supply voltage is 24 V.

- $V_{ON} (14.4 V) \leq V_{CC} (20.4 V) - V_R (3 V) = 17.4 V$: OK
- $I_{OFF} (1.3 mA) \geq I_{leak} (0.8 mA)$: OK
- $I_{ON} = [V_{CC} (20.4 V) - V_R (3 V) - V_{PC} (4 V)] / R_{IN} (3 k\Omega) = \text{Approx. } 4.5 mA$

Therefore, $I_{OUT} (min.) (3 mA) \leq I_{ON} (4.5 mA)$: OK
 Connection is thus possible.

Connection Example (Reference)

PLC	V_{ON} : ON voltage (14.4 V) I_{ON} : ON current (typically 7 mA) I_{OFF} : OFF current (1.3 mA) R_{IN} : Input impedance (3 k Ω) V_{PC} : Internal residual voltage (4 V)
Proximity Sensor	V_R : Output residual voltage (3 V) I_{leak} : Leakage current (0.8 mA) I_{OUT} : Control output (3 to 100 mA) V_{CC} : Power supply voltage (PLC: 20.4 to 26.4 V)

Dimensions

(Unit: mm)
Tolerance class IT16 applies to dimensions in this data sheet unless otherwise specified.

Sensors

DC 2-Wire

No Self-diagnosis Output, PUR Cable models

Pre-wired Models (Shielded)

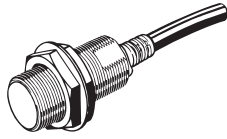

Pre-wired Connector Models (Shielded)

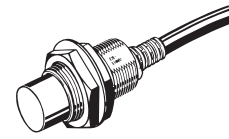

E2E-X2D□-U

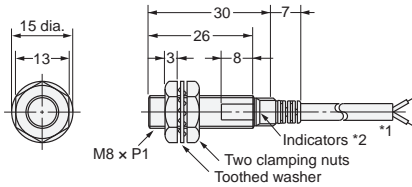

*1. 4-dia. polyurethane-insulated round cable with 2 conductors (Conductor cross section: 0.3 mm², Insulator diameter: 1.3 mm), Standard length: 2 m
The cable can be extended up to 200 m (separate metal conduit).
*2. D1 Models: Operation indicator (red) and setting indicator (green), D2 Models: Operation indicator (red)

E2E-X2D□-M1TGJ-U

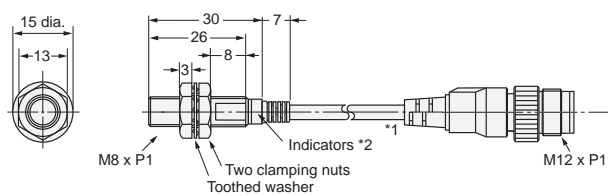

*1. 4-dia. Polyurethane insulated round cable, Standard length: 0.3 m
*2. D1 Models: Operation indicator (red) and Setting indicator (green), D2 Models: Operation indicator (red)

E2E-X3D□-U

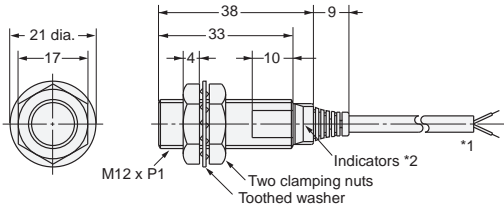

*1. 4-dia. polyurethane-insulated round cable with 2 conductors (Conductor cross section: 0.3 mm², Insulator diameter: 1.3 mm), Standard length: 2 m
The cable can be extended (separate metal conduit) up to 200 m for the control output.
*2. D1 Models: Operation indicator (red) and setting indicator (green), D2 Models: Operation indicator (red)

E2E-X3D□-M1TGJ-U

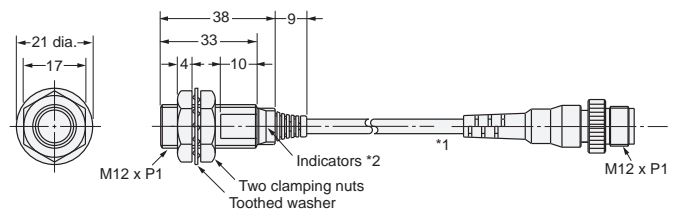

*1. 4-dia. Polyurethane insulated round cable, Standard length: 0.3 m
*2. D1 Models: Operation indicator (red) and Setting indicator (green), D2 Models: Operation indicator (red)

E2E-X7D□-U

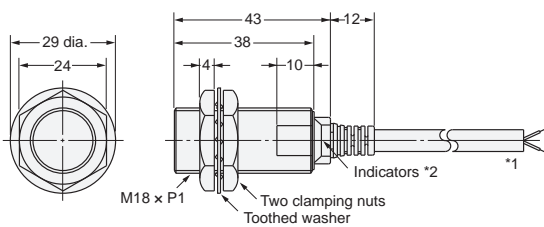

*1. 6-dia. polyurethane-insulated round cable with 2 conductors (Conductor cross section: 0.5 mm², Insulator diameter: 1.9 mm), Standard length: 2 m
The cable can be extended (separate metal conduit) up to 200 m for the control output.
*2. D1 Models: Operation indicator (red) and setting indicator (green), D2 Models: Operation indicator (red)

E2E-X7D□-M1TGJ-U

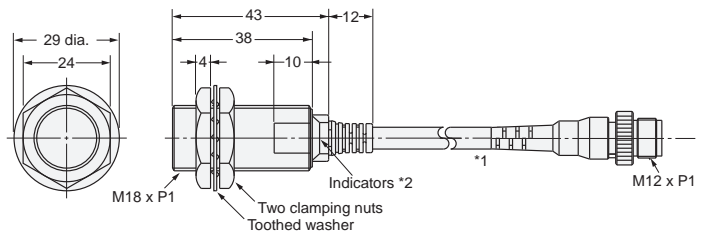

*1. 6-dia. Polyurethane insulated round cable, Standard length: 0.3 m
*2. D1 Models: Operation indicator (red) and Setting indicator (green), D2 Models: Operation indicator (red)

E2E-X10D□-U

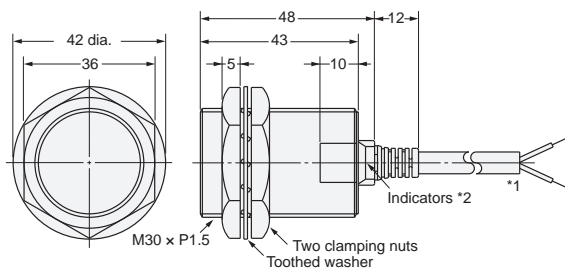

*1. 6-dia. polyurethane-insulated round cable with 2 conductors (Conductor cross section: 0.5 mm², Insulator diameter: 1.9 mm), Standard length: 2 m
The cable can be extended (separate metal conduit) up to 200 m for the control output.
*2. D1 Models: Operation indicator (red) and setting indicator (green), D2 Models: Operation indicator (red)

E2E-X10D□-M1TGJ-U

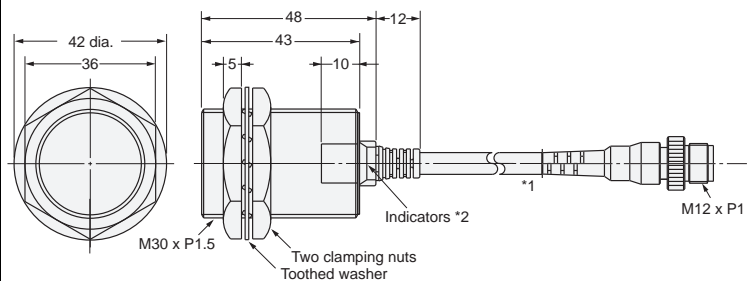

*1. 6-dia. Polyurethane insulated round cable, Standard length: 0.3 m
*2. D1 Models: Operation indicator (red) and Setting indicator (green), D2 Models: Operation indicator (red)

Mounting Hole Dimensions

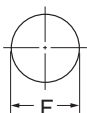

Dimensions	M8	M12	M18	M30
F (mm)	8.5 ^{+0.5} ₀ dia.	12.5 ^{+0.5} ₀ dia.	18.5 ^{+0.5} ₀ dia.	30.5 ^{+0.5} ₀ dia.

**DC 2-Wire
Self-diagnosis Output models**

**Pre-wired Models
(Shielded)**

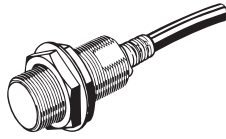

**Pre-wired Models
(Unshielded)**

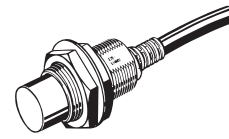

E2E-X3D1S

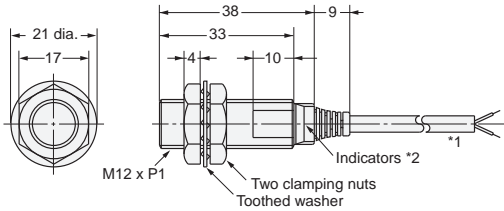

*1. 4-dia. polyurethane-insulated round cable with 2 conductors (Conductor cross section: 0.3 mm², Insulator diameter: 1.3 mm), Standard length: 2 m
The cable can be extended (separate metal conduit) up to 200 m for the control output and up to 100 m for the diagnostic output.
*2. Operation indicator (red) and setting indicator (green)

E2E-X8MD1S

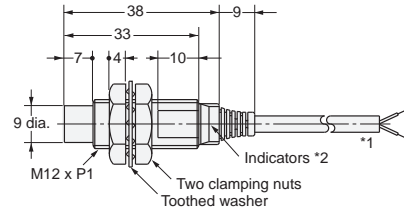

*1. 4-dia. polyurethane-insulated round cable with 2 conductors (Conductor cross section: 0.3 mm², Insulator diameter: 1.3 mm), Standard length: 2 m
The cable can be extended (separate metal conduit) up to 200 m for the control output and up to 100 m for the diagnostic output.
*2. Operation indicator (red) and setting indicator (green)

E2E-X7D1S

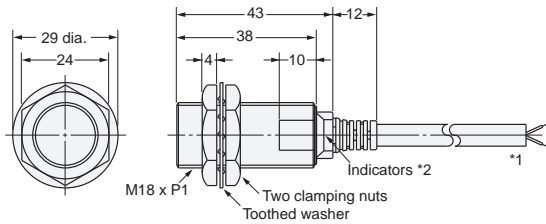

*1. 6-dia. polyurethane-insulated round cable with 2 conductors (Conductor cross section: 0.5 mm², Insulator diameter: 1.9 mm), Standard length: 2 m
The cable can be extended (separate metal conduit) up to 200 m for the control output and up to 100 m for the diagnostic output.
*2. Operation indicator (red) and setting indicator (green)

E2E-X14MD1S

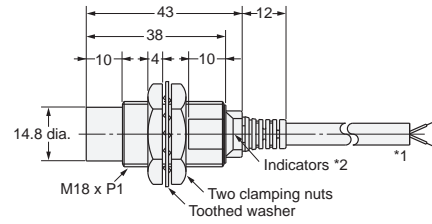

*1. 6-dia. polyurethane-insulated round cable with 2 conductors (Conductor cross section: 0.5 mm², Insulator diameter: 1.9 mm), Standard length: 2 m
The cable can be extended (separate metal conduit) up to 200 m for the control output and up to 100 m for the diagnostic output.
*2. Operation indicator (red) and setting indicator (green)

E2E-X10D1S

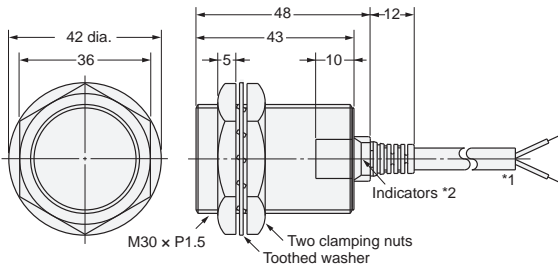

*1. 6-dia. polyurethane-insulated round cable with 2 conductors (Conductor cross section: 0.5 mm², Insulator diameter: 1.9 mm), Standard length: 2 m
The cable can be extended (separate metal conduit) up to 200 m for the control output and up to 100 m for the diagnostic output.
*2. Operation indicator (red) and setting indicator (green)

E2E-X20MD1S

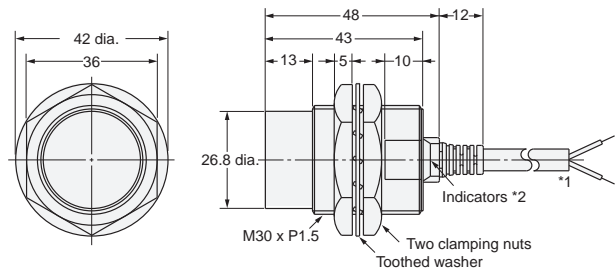

*1. 6-dia. polyurethane-insulated round cable with 2 conductors (Conductor cross section: 0.5 mm², Insulator diameter: 1.9 mm), Standard length: 2 m
The cable can be extended (separate metal conduit) up to 200 m for the control output and up to 100 m for the diagnostic output.
*2. Operation indicator (red) and setting indicator (green)

Mounting Hole Dimensions

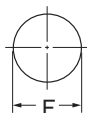

Dimension	M12	M18	M30
F (mm)	12.5 ^{+0.5} dia.	18.5 ^{+0.5} dia.	30.5 ^{+0.5} dia.

Sensors
DC 2-Wire
Self-diagnosis Output models

M12 Connector Models (Shielded)

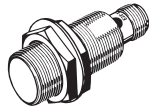

M12 Connector Models (Unshielded)

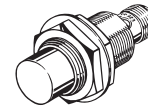

E2E-X3D1S-M1

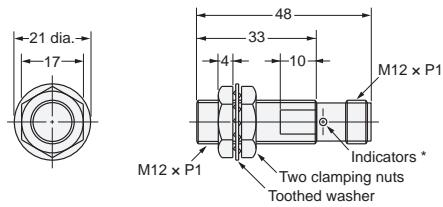

* Operation indicator (red), Setting indicator (green)

E2E-X8MD1S-M1

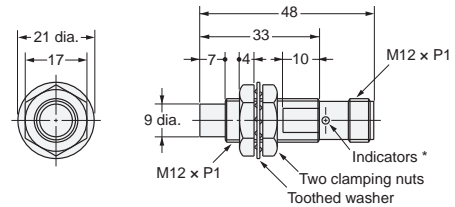

* Operation indicator (red), Setting indicator (green)

E2E-X7D1S-M1

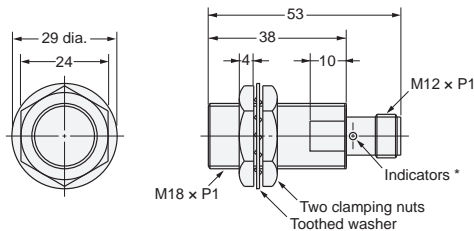

* Operation indicator (red), Setting indicator (green)

E2E-X14MD1S-M1

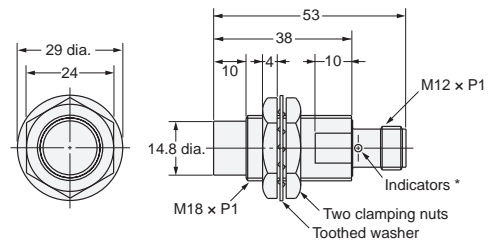

* Operation indicator (red), Setting indicator (green)

E2E-X10D1S-M1

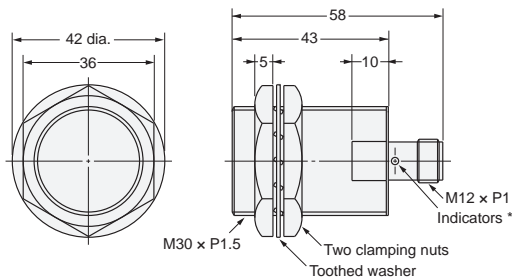

* Operation indicator (red), Setting indicator (green)

E2E-X20MD1S-M1

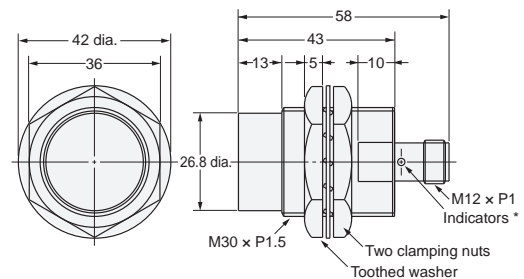

* Operation indicator (red), Setting indicator (green)

Mounting Hole Dimensions



Dimension	M12	M18	M30
F (mm)	12.5 ^{+0.5} ₀ dia.	18.5 ^{+0.5} ₀ dia.	30.5 ^{+0.5} ₀ dia.

AC 2-Wire

Pre-wired Models
(Shielded)

Pre-wired Models
(Unshielded)

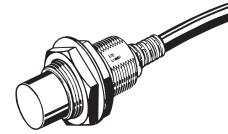

E2E-X1R5Y□

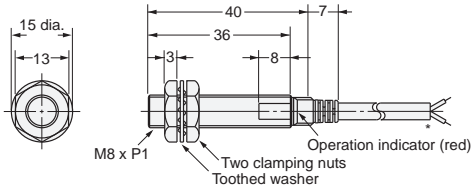

* 4-dia. vinyl-insulated round cable with 2 conductors (Conductor cross section: 0.3 mm², Insulator, diameter: 1.3 mm), Standard length: 2 m
The cable can be extended up to 200 m (separate metal conduit).

E2E-X2MY□

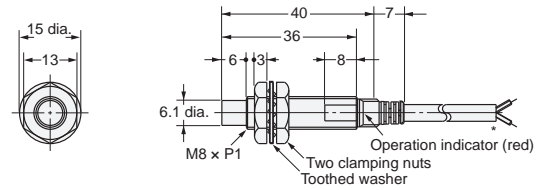

* 4-dia. vinyl-insulated round cable with 2 conductors (Conductor cross section: 0.3 mm², Insulator, diameter: 1.3 mm), Standard length: 2 m
The cable can be extended up to 200 m (separate metal conduit).

E2E-X2Y□

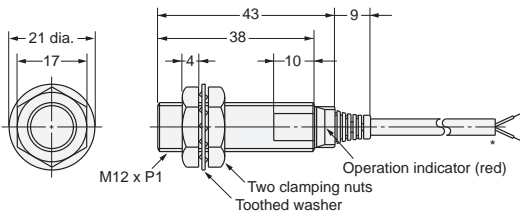

* 4-dia. vinyl-insulated round cable with 2 conductors (Conductor cross section: 0.3 mm², Insulator, diameter: 1.3 mm), Standard length: 2 m
The cable can be extended up to 200 m (separate metal conduit).

E2E-X5MY□

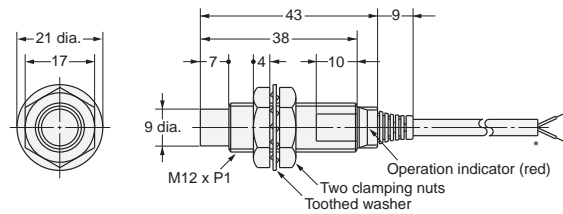

* 4-dia. vinyl-insulated round cable with 2 conductors (Conductor cross section: 0.3 mm², Insulator, diameter: 1.3 mm), Standard length: 2 m
The cable can be extended up to 200 m (separate metal conduit).

E2E-X5Y□

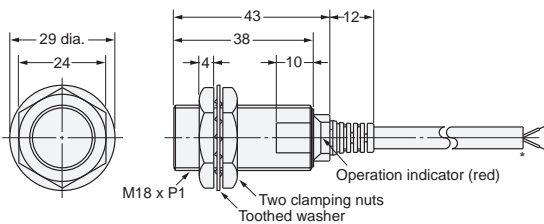

* 6-dia. vinyl-insulated round cable with 2 conductors (Conductor cross section: 0.5 mm², Insulator, diameter: 1.9 mm), Standard length: 2 m
The cable can be extended up to 200 m (separate metal conduit).

E2E-X10MY□

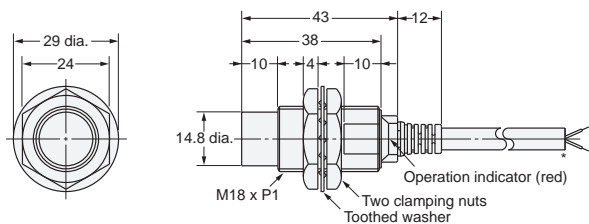

* 6-dia. vinyl-insulated round cable with 2 conductors (Conductor cross section: 0.5 mm², Insulator, diameter: 1.9 mm), Standard length: 2 m
The cable can be extended up to 200 m (separate metal conduit).

E2E-X10Y□

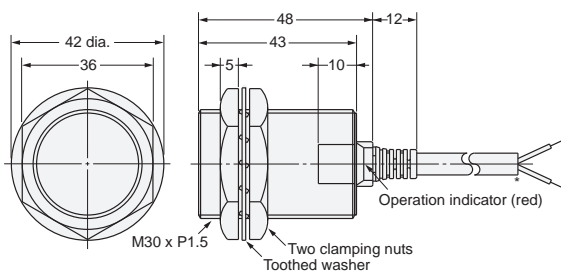

* 6-dia. vinyl-insulated round cable with 2 conductors (Conductor cross section: 0.5 mm², Insulator, diameter: 1.9 mm), Standard length: 2 m
The cable can be extended up to 200 m (separate metal conduit).

E2E-X18MY□

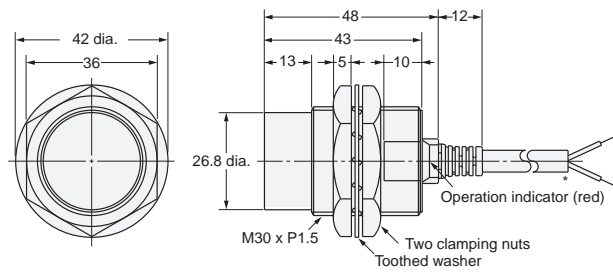

* 6-dia. vinyl-insulated round cable with 2 conductors (Conductor cross section: 0.5 mm², Insulator, diameter: 1.9 mm), Standard length: 2 m
The cable can be extended up to 200 m (separate metal conduit).

Mounting Hole Dimensions

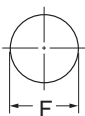

Dimensions	M8	M12	M18	M30
F (mm)	8.5 ^{+0.5} ₀ dia.	12.5 ^{+0.5} ₀ dia.	18.5 ^{+0.5} ₀ dia.	30.5 ^{+0.5} ₀ dia.

Sensors
AC 2-Wire

M12 Connector Models
(Shielded)

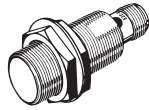

M12 Connector Models
(Unshielded)

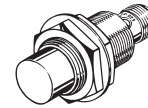

E2E-X2Y□-M1

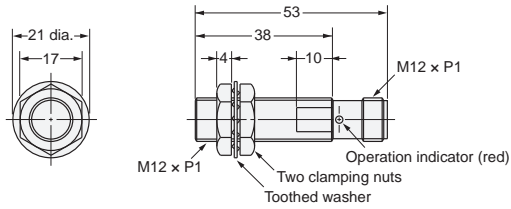

E2E-X5MY□-M1

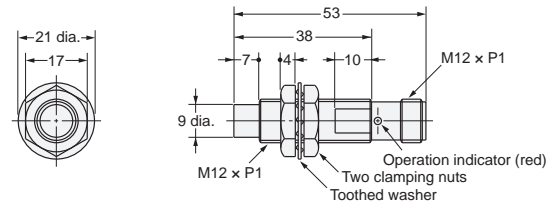

E2E-X5Y□-M1

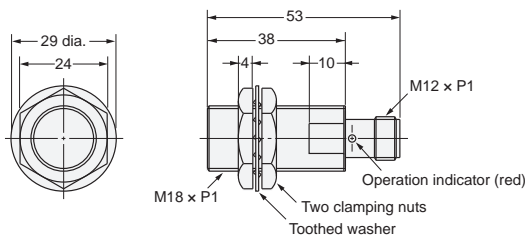

E2E-X10MY□-M1

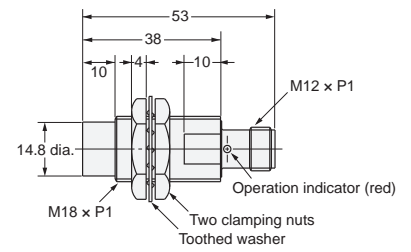

E2E-X10Y□-M1

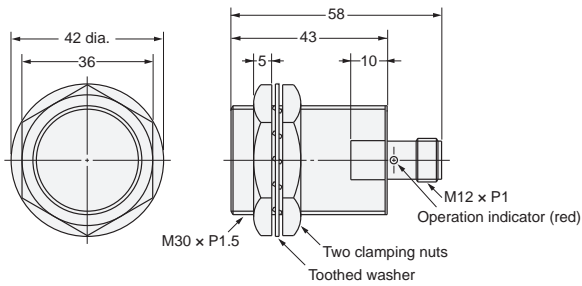

E2E-X18MY□-M1

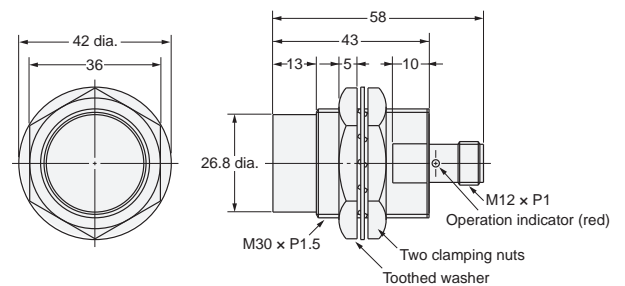

Mounting Hole Dimensions



Dimension	M12	M18	M30
F (mm)	12.5 ^{+0.5} dia.	18.5 ^{+0.5} dia.	30.5 ^{+0.5} dia.

AC/DC 2-Wire

Pre-wired Models
(Shielded)

E2E-X3T1

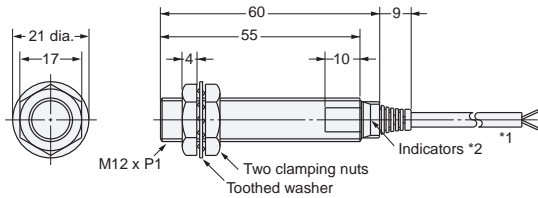

- *1. 4-dia. vinyl-insulated round cable with 2 conductors (Conductor cross section: 0.3 mm², Insulator diameter: 1.3 mm), Standard length: 2 m. The cable can be extended up to 200 m (separate metal conduit).
- *2. Operation indicator (red), Setting indicator (green)

E2E-X7T1

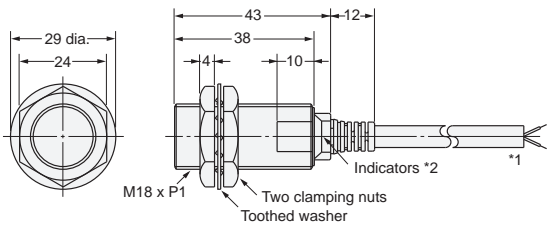

- *1. 6-dia. vinyl-insulated round cable with 2 conductors (Conductor cross section: 0.5 mm², Insulator diameter: 1.9 mm), Standard length: 2 m. The cable can be extended (separate metal conduit) up to 200 m for the control output and up to 100 m for the diagnostic output.
- *2. Operation indicator (red), Setting indicator (green)

E2E-X10T1

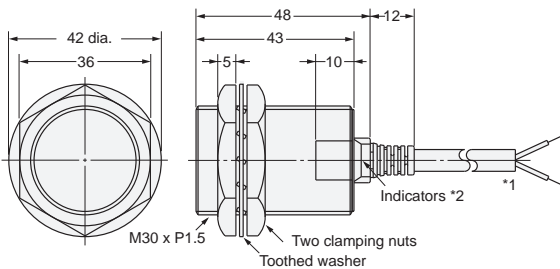

- *1. 6-dia. vinyl-insulated round cable with 2 conductors (Conductor cross section: 0.5 mm², Insulator diameter: 1.9 mm), Standard length: 2 m. The cable can be extended (separate metal conduit) up to 200 m for the control output and up to 100 m for the diagnostic output.
- *2. Operation indicator (red), Setting indicator (green)

Mounting Hole Dimensions

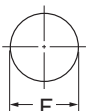

Dimensions	M12	M18	M30
F (mm)	12.5 ^{+0.5} dia.	18.5 ^{+0.5} dia.	30.5 ^{+0.5} dia.

Dimensions for Proximity Sensors with Sensor I/O Connectors

Shielded Models

Unshielded Models

Straight Connectors

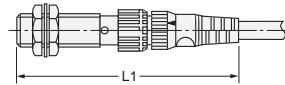

Straight Connectors

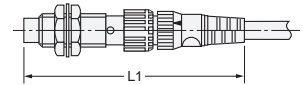

L-shape Connectors

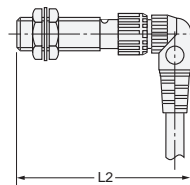

L-shape Connectors

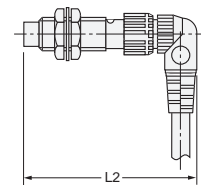

Dimensions with the XS2F Connected

(Unit: mm)

Dimension		L1	L2
Sensor diameter			
M8		Approx. 75	Approx. 62
M12*	DC	Approx. 80	Approx. 67
	AC	Approx. 85	Approx. 72
M18		Approx. 85	Approx. 72
M30		Approx. 90	Approx. 77

* The overall length of the Sensor is different between AC and DC Models for Sensors with diameters of M12. This will change the dimension when the I/O Connector is connected.

Mounting Brackets

Protective Covers

Sputter Protective Covers

Refer to Y92□ for details.

Terms and Conditions Agreement

Read and understand this catalog.

Please read and understand this catalog before purchasing the products. Please consult your OMRON representative if you have any questions or comments.

Warranties.

(a) Exclusive Warranty. Omron's exclusive warranty is that the Products will be free from defects in materials and workmanship for a period of twelve months from the date of sale by Omron (or such other period expressed in writing by Omron). Omron disclaims all other warranties, express or implied.

(b) Limitations. OMRON MAKES NO WARRANTY OR REPRESENTATION, EXPRESS OR IMPLIED, ABOUT NON-INFRINGEMENT, MERCHANTABILITY OR FITNESS FOR A PARTICULAR PURPOSE OF THE PRODUCTS. BUYER ACKNOWLEDGES THAT IT ALONE HAS DETERMINED THAT THE PRODUCTS WILL SUITABLY MEET THE REQUIREMENTS OF THEIR INTENDED USE.

Omron further disclaims all warranties and responsibility of any type for claims or expenses based on infringement by the Products or otherwise of any intellectual property right. (c) Buyer Remedy. Omron's sole obligation hereunder shall be, at Omron's election, to (i) replace (in the form originally shipped with Buyer responsible for labor charges for removal or replacement thereof) the non-complying Product, (ii) repair the non-complying Product, or (iii) repay or credit Buyer an amount equal to the purchase price of the non-complying Product; provided that in no event shall Omron be responsible for warranty, repair, indemnity or any other claims or expenses regarding the Products unless Omron's analysis confirms that the Products were properly handled, stored, installed and maintained and not subject to contamination, abuse, misuse or inappropriate modification. Return of any Products by Buyer must be approved in writing by Omron before shipment. Omron Companies shall not be liable for the suitability or unsuitability or the results from the use of Products in combination with any electrical or electronic components, circuits, system assemblies or any other materials or substances or environments. Any advice, recommendations or information given orally or in writing, are not to be construed as an amendment or addition to the above warranty.

See <http://www.omron.com/global/> or contact your Omron representative for published information.

Limitation on Liability: Etc.

OMRON COMPANIES SHALL NOT BE LIABLE FOR SPECIAL, INDIRECT, INCIDENTAL, OR CONSEQUENTIAL DAMAGES, LOSS OF PROFITS OR PRODUCTION OR COMMERCIAL LOSS IN ANY WAY CONNECTED WITH THE PRODUCTS, WHETHER SUCH CLAIM IS BASED IN CONTRACT, WARRANTY, NEGLIGENCE OR STRICT LIABILITY.

Further, in no event shall liability of Omron Companies exceed the individual price of the Product on which liability is asserted.

Suitability of Use.

Omron Companies shall not be responsible for conformity with any standards, codes or regulations which apply to the combination of the Product in the Buyer's application or use of the Product. At Buyer's request, Omron will provide applicable third party certification documents identifying ratings and limitations of use which apply to the Product. This information by itself is not sufficient for a complete determination of the suitability of the Product in combination with the end product, machine, system, or other application or use. Buyer shall be solely responsible for determining appropriateness of the particular Product with respect to Buyer's application, product or system. Buyer shall take application responsibility in all cases.

NEVER USE THE PRODUCT FOR AN APPLICATION INVOLVING SERIOUS RISK TO LIFE OR PROPERTY OR IN LARGE QUANTITIES WITHOUT ENSURING THAT THE SYSTEM AS A WHOLE HAS BEEN DESIGNED TO ADDRESS THE RISKS, AND THAT THE OMRON PRODUCT(S) IS PROPERLY RATED AND INSTALLED FOR THE INTENDED USE WITHIN THE OVERALL EQUIPMENT OR SYSTEM.

Programmable Products.

Omron Companies shall not be responsible for the user's programming of a programmable Product, or any consequence thereof.

Performance Data.

Data presented in Omron Company websites, catalogs and other materials is provided as a guide for the user in determining suitability and does not constitute a warranty. It may represent the result of Omron's test conditions, and the user must correlate it to actual application requirements. Actual performance is subject to the Omron's Warranty and Limitations of Liability.

Change in Specifications.

Product specifications and accessories may be changed at any time based on improvements and other reasons. It is our practice to change part numbers when published ratings or features are changed, or when significant construction changes are made. However, some specifications of the Product may be changed without any notice. When in doubt, special part numbers may be assigned to fix or establish key specifications for your application. Please consult with your Omron's representative at any time to confirm actual specifications of purchased Product.

Errors and Omissions.

Information presented by Omron Companies has been checked and is believed to be accurate; however, no responsibility is assumed for clerical, typographical or proofreading errors or omissions.