

Single Switch PWM Controller with Auxiliary Boost Converter

FEATURES

- **Wide Input Range: 3V to 25V**
- **Programmable Volt-Second Clamp**
- **Output Power Levels from 25W to 500W**
- **Auxiliary Boost Converter Provides 10V Gate Drive from V_{IN} as Low as 3V**
- **Programmable Operating Frequency (100kHz to 500kHz) with One External Resistor**
- **Programmable Slope Compensation**
- **Programmable Leading Edge Blanking**
- $\pm 2\%$ Internal 1.23V Reference
- Accurate Shutdown Pin Threshold with Programmable Hysteresis
- 60ns Current Sense Delay
- 2.5V Auxiliary Reference Output
- Synchronizable to an External Clock up to $1.5 \cdot f_{OSC}$
- Current Mode Control
- Small 16-Pin SSOP Package

APPLICATIONS

- Telecom Power Supplies
- Automotive Power Supplies
- Portable Electronic Equipment
- Isolated and Nonisolated DC/DC Converters

DESCRIPTION

The LT[®]1950 is a wide input range, forward, boost, flyback and SEPIC controller that drives an N-channel power MOSFET with few external components required.

A resistor programmable duty cycle clamp can be used to generate a volt-second clamp for forward converter applications. An internal boost switcher is available for creating a separate supply for the output gate driver, allowing 10V gate drive from input voltages as low as 3V. The LT1950's operating frequency can be set with an external resistor over a 100kHz to 500kHz range and a SYNC pin allows the part to be synchronized to an external clock. Additional programmability exists for leading edge blanking and slope compensation.

A fast current sense comparator achieves 60ns current sense delay and the error amplifier is a true voltage mode error amplifier, allowing a wide range of compensation networks. An accurate shutdown pin with programmable hysteresis is available for undervoltage lockout and shutdown. The LT1950 is available in a small 16-Pin SSOP package.

LT, LTC and LT are registered trademarks of Linear Technology Corporation.

TYPICAL APPLICATION

36V to 72V DC to 26V/5A (Single Switch) Forward Converter

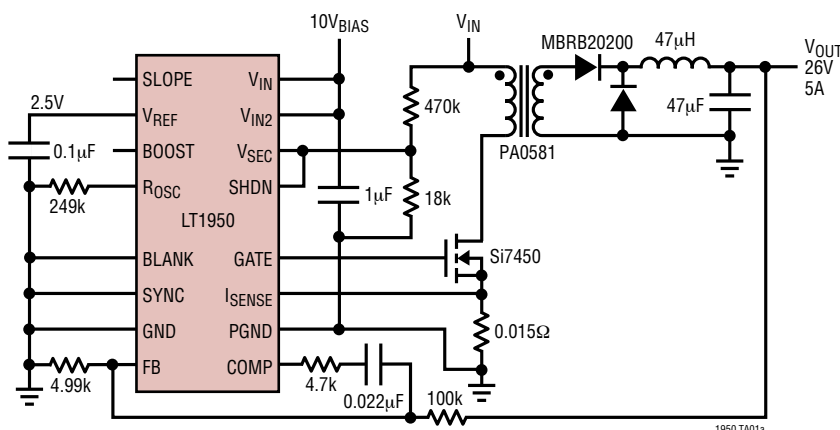

Efficiency vs Load Current

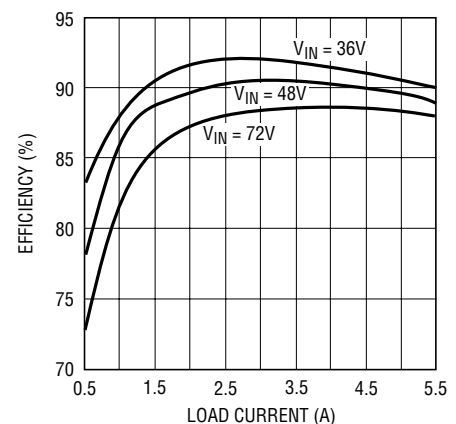

1950 TA01b 1950fa

ABSOLUTE MAXIMUM RATINGS

(Note 1)

BOOST	-0.3V to 35V
V _{IN} , V _{IN2} , SHDN	-0.3V to 25V
FB, SYNC, V _{SEC}	-0.3V to 6V
COMP, BLANK	-0.3V to 3.5V
SLOPE	-0.3V to 2.5V
I _{SENSE}	-0.3V to 1V
R _{OSC}	-50μA
V _{REF}	-10mA
Operating Junction Temperature Range	
LT1950EGN/LT1950IGN (Notes 2, 5) ...	-40°C to 125°C
Storage Temperature Range	-65°C to 150°C
Lead Temperature (Soldering, 10 sec)	300°C

PACKAGE/ORDER INFORMATION

<p>GN PACKAGE 16-LEAD NARROW PLASTIC SSOP T_{JMAX} = 125°C, θ_{JA} = 110°C/W, θ_{JC} (PIN 8) = 30°C/W</p>	ORDER PART NUMBER
	LT1950EGN LT1950IGN
	GN PART MARKING
	1950E 1950I

Consult LTC Marketing for parts specified with wider operating temperature ranges.

ELECTRICAL CHARACTERISTICS

The ● denotes the specifications which apply over the full operating temperature range, otherwise specifications are at T_A = 25°C. COMP = open, FB = 1.4V, R_{OSC} = 249k, SYNC = 0V, SLOPE = open, V_{REF} = 0.1μF, SHDN = V_{IN}, BLANK = 0V, I_{SENSE} = 0V, V_{IN2} = 15V, GATE = 1nF, BOOST = open, V_{IN} = 15V, V_{SEC} = 0V, unless otherwise specified.

PARAMETER	CONDITIONS	MIN	TYP	MAX	UNITS	
PWM Controller						
Operating Input Voltage	I _{VREF} = 0μA	●	3.0	25	V	
Minimum Start-Up Voltage	I _{VREF} = 0μA	●	2.6	3.0	V	
V _{IN} Quiescent Current	I _{VREF} = 0μA, FB = 1V, I _{SENSE} = 0.2V		2.3	3.0	mA	
V _{IN} Shutdown Current	SHDN = 0V		5	20	μA	
Shutdown Threshold	3V < V _{IN} < 25V	●	1.261	1.32	1.379	V
Shutdown Pin Current	SHDN = 70mV Above Threshold		-7	-10	-13	μA
Shutdown Pin Current Hysteresis	SHDN = 100mV Below Threshold		4	7	10	μA
V _{IN2} Quiescent Current	I(V _{REF}) = 0μA, FB = 1V, I _{SENSE} = 0.2V		1.7	2.5	mA	
V _{IN2} Shutdown Current	SHDN = 0V, V _{IN2} = 2.7V (Boost Diode from V _{IN} = 3V)		500	700	μA	
V_{REF} (External Output)						
Output Voltage	I _{VREF} = 0μA	●	2.425	2.500	2.575	V
Line Regulation	I _{VREF} = 0μA, 3V < V _{IN} < 25V		1	5	mV	
Load Regulation	0μA < I _{VREF} < 2.5mA		1	5	mV	
Oscillator						
Frequency: f _{OSC}	R _{OSC} = 249k, FB = 1V	●	170	200	230	kHz
Minimum Programmable f _{OSC}	R _{OSC} = 499k		85	100	115	kHz
Maximum Programmable f _{OSC}	R _{OSC} = 90.9k		440	500	560	kHz
SYNC Input Resistance			20		kΩ	
SYNC Switching Threshold			1.5	2.2	V	
SYNC Frequency/f _{OSC}	(R _{OSC} = 249k, f _{OSC} = 200kHz), FB = 1V (Note 7)		1.25	1.5		
f _{OSC} Line Reg	3V < V _{IN} < 25V		0.05	0.15	%/V	
	9.5V < V _{IN2} < 25V		0.05	0.25	%/V	
V _{ROSC}			1		V	

1950fa

ELECTRICAL CHARACTERISTICS

The ● denotes the specifications which apply over the full operating temperature range, otherwise specifications are at $T_A = 25^\circ\text{C}$. COMP = open, FB = 1.4V, $R_{\text{OSC}} = 249\text{k}$, SYNC = 0V, SLOPE = open, $V_{\text{REF}} = 0.1\mu\text{F}$, SHDN = V_{IN} , BLANK = 0V, $I_{\text{SENSE}} = 0\text{V}$, $V_{\text{IN}2} = 15\text{V}$, GATE = 1nF, BOOST = open, $V_{\text{IN}} = 15\text{V}$, $V_{\text{SEC}} = 0\text{V}$, unless otherwise specified.

PARAMETER	CONDITIONS		MIN	TYP	MAX	UNITS
Error Amplifier						
FB Reference Voltage	$3\text{V} < V_{\text{IN}} < 25\text{V}$, $V_{\text{OL}} + 0.2\text{V} < \text{COMP} < V_{\text{OH}} - 0.2$	●	1.205	1.230	1.254	V
FB Input Bias Current	FB = FB Reference Voltage			-75	-200	nA
Open Loop Voltage Gain	$V_{\text{OL}} + 0.2\text{V} < \text{COMP} < V_{\text{OH}} - 0.2$		65	85		dB
Unity Gain Bandwidth	(Note 6)			3		MHz
COMP Source Current	FB = 1V, COMP = 1.6V	●	-0.3	-1.1	-1.8	mA
COMP Sink Current	FB = 1.4V, COMP = 1.6V		8	13		mA
COMP High Level: V_{OH}	FB = 1V, $I_{\text{COMP}} = -250\mu\text{A}$			2.5		V
COMP Active Threshold	Start of GATE Switching (Duty Cycle > 0%)			1.0		V
COMP Low Level: V_{OL}	FB = 1.4V, $I_{\text{COMP}} = 250\mu\text{A}$			0.15		V
Current Sense						
I_{SENSE} Maximum Threshold	Duty Cycle < 10%, COMP = V_{OH}		90	100	110	mV
I_{SENSE} Input Bias Current	COMP = 2.5V, $I_{\text{SENSE}} = I_{\text{SENSE Max Threshold}}$		-125	-170	-250	μA
Default Blanking Time	FB = 1V, COMP = 2V, $I_{\text{SENSE}} = 75\text{mV}$			110		ns
Adjustable Blanking Time	FB = 1V, COMP = 2V, $I_{\text{SENSE}} = 75\text{mV}$ BLANK = 75k to Ground			290		ns
Blanking Override Voltage– I_{SENSE} Maximum Threshold	BLANK = Open, COMP = 2.5V (Note 4)		15	25	40	mV
Turn-Off Delay to Gate	COMP = 2V			60		ns
Slope Compensation (Note 4)	I_{SENSE} Max Threshold (DC < 10%) – (DC = 80%) (Note 4) Default, $R_{\text{SLOPE}} = \infty$ 2x Default, $R_{\text{SLOPE}} = 8\text{k}$ 3x Default, $R_{\text{SLOPE}} = 3.3\text{k}$			14 28 42		mV mV mV
Internal Switcher						
Boost Switch I_{LIMIT}	$V_{\text{IN}2} = 8\text{V}$, $3\text{V} < V_{\text{IN}} < 10\text{V}$		70	125	180	mA
Boost Switch Off Time	$V_{\text{IN}2} = 8\text{V}$, $3\text{V} < V_{\text{IN}} < 10\text{V}$		250	500	1000	ns
$V_{\text{IN}2}$: Boost Disable	$3\text{V} < V_{\text{IN}} < 10\text{V}$	●	9.5	11.0	11.75	V
$V_{\text{IN}2}$: Boost Disable Hysteresis	$3\text{V} < V_{\text{IN}} < 10\text{V}$			-1.0		V
$V_{\text{IN}2}$: Gate Enable	$3\text{V} < V_{\text{IN}} < 10\text{V}$, FB = 1V (Note 4)	●	7.0	8.2	9.27	V
$V_{\text{IN}2}$: Gate Enable Hysteresis	$3\text{V} < V_{\text{IN}} < 10\text{V}$, FB = 1V (Note 4)			-0.6		V
GATE Driver Output						
GATE Rise Time	FB = 1V, $V_{\text{IN}2} = 12\text{V}$, $C_L = 1\text{nF}$ (Notes 3, 6)			50		ns
GATE Fall Time	FB = 1V, $V_{\text{IN}2} = 12\text{V}$, $C_L = 1\text{nF}$ (Notes 3, 6)			30		ns
GATE Clamp Voltage	$I_{\text{GATE}} = 0\mu\text{A}$, COMP = 2.5V, FB = 6V		11.5	13	14.5	V
GATE Low Level	$I_{\text{GATE}} = 20\text{mA}$ $I_{\text{GATE}} = 200\text{mA}$			0.25 1.2	0.4 1.75	V V
GATE High Level	$I_{\text{GATE}} = -20\text{mA}$, $V_{\text{IN}2} = 12\text{V}$, COMP = 2.5V, FB = 6V $I_{\text{GATE}} = -200\text{mA}$, $V_{\text{IN}2} = 12\text{V}$, COMP = 2.5V, FB = 6V		10 9.75			V V
Maximum Duty Cycle	FB = 1V, $f_{\text{OSC}} = 200\text{kHz}$		90	95	97	%

ELECTRICAL CHARACTERISTICS

The ● denotes the specifications which apply over the full operating temperature range, otherwise specifications are at $T_A = 25^\circ\text{C}$. COMP = open, FB = 1.4V, $R_{DSC} = 249\text{k}$, SYNC = 0V, SLOPE = open, $V_{REF} = 0.1\mu\text{F}$, SHDN = V_{IN} , BLANK = 0V, $I_{SENSE} = 0\text{V}$, $V_{IN2} = 15\text{V}$, GATE = 1nF, BOOST = open, $V_{IN} = 15\text{V}$, $V_{SEC} = 0\text{V}$, unless otherwise specified.

PARAMETER	CONDITIONS	MIN	TYP	MAX	UNITS
Maximum Duty Cycle Clamp	$V_{SEC} = 1.4\text{V}$, FB = 1V, COMP = V_{OH}	63	75	87	%
V_{SEC} Input Bias Current	$0\text{V} < V_{SEC} < 2.8\text{V}$		-0.3	-1.0	μA

Note 1: Absolute Maximum Ratings are those values beyond which the life of a device may be impaired.

Note 2: The LT1950EGN is guaranteed to meet performance specifications from 0°C to 125°C operating junction temperature. Specifications over the -40°C to 125°C operating junction temperature range are assured by design, characterization and correlation with statistical process controls. The LT1950IGN is guaranteed over the full -40°C to 125°C operating junction temperature range.

Note 3: Rise and Fall times are between 10% and 90% levels.

Note 4: Guaranteed by correlation to static test.

Note 5: This IC includes overtemperature protection that is intended to protect the device during momentary overload conditions. Junction temperature will exceed 125°C when overtemperature protection is active. Continuous operation above the specified maximum operating junction temperature may impair device reliability.

Note 6: Guaranteed but not tested.

Note 7: Maximum recommended SYNC frequency = 500kHz.

TYPICAL PERFORMANCE CHARACTERISTICS

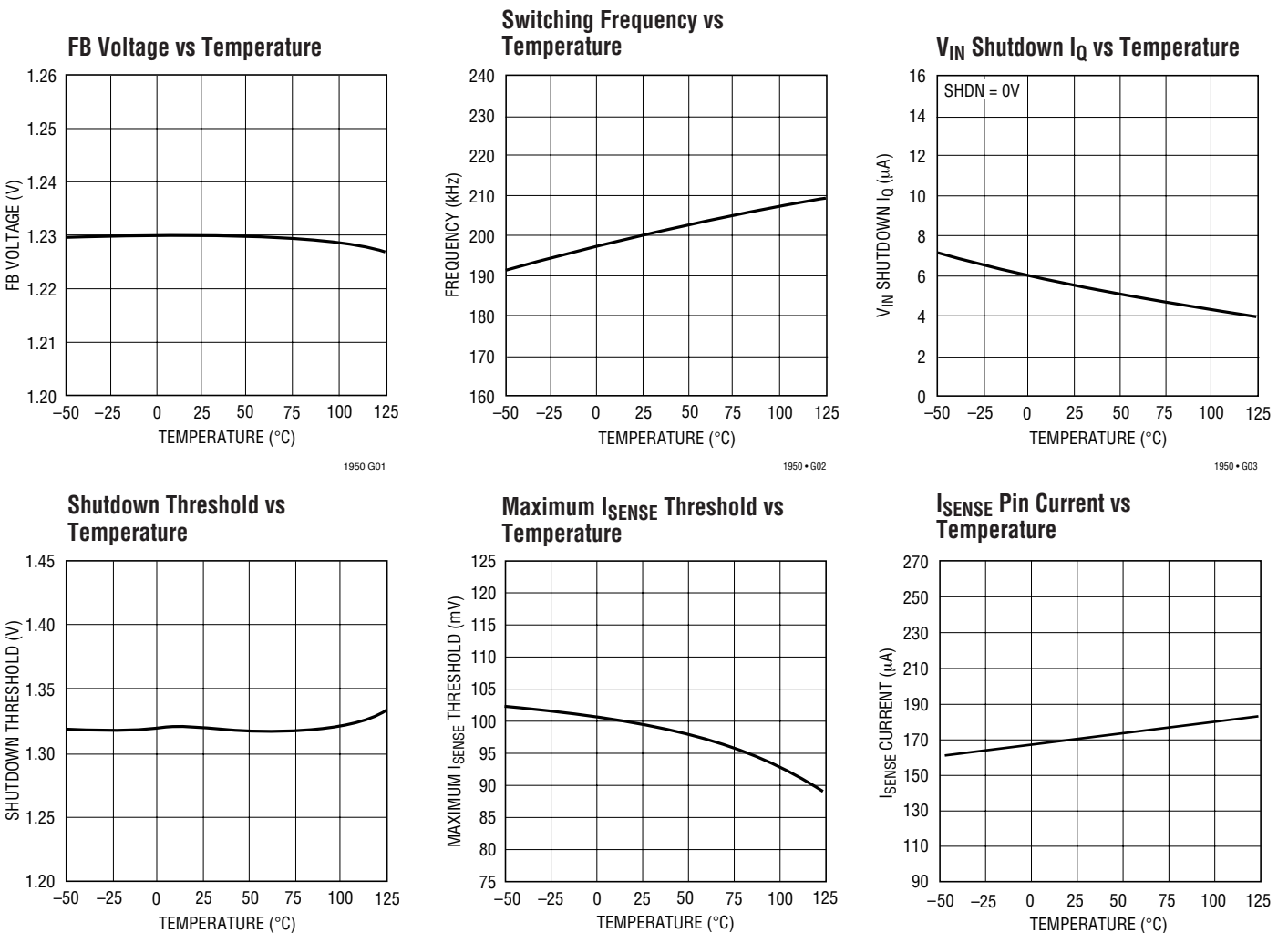

TYPICAL PERFORMANCE CHARACTERISTICS

**BLANK Override Threshold –
I_{SENSE} Maximum Threshold vs
Temperature**

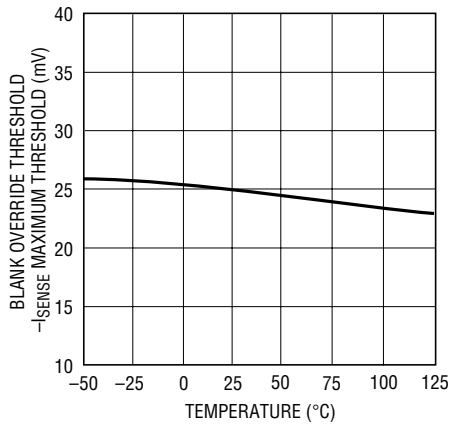

1950 G07

**Minimum V_{IN} Start-Up Voltage vs
Temperature (V_{IN2} Boosted)**

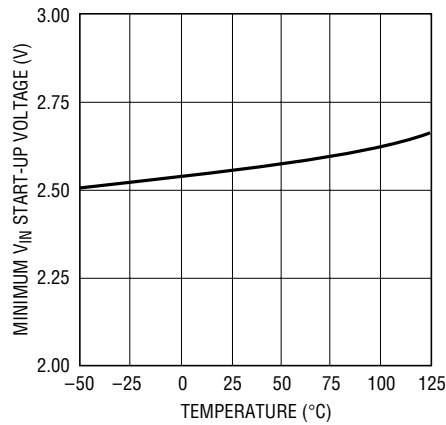

1950 G08

V_{IN} I_Q vs Temperature

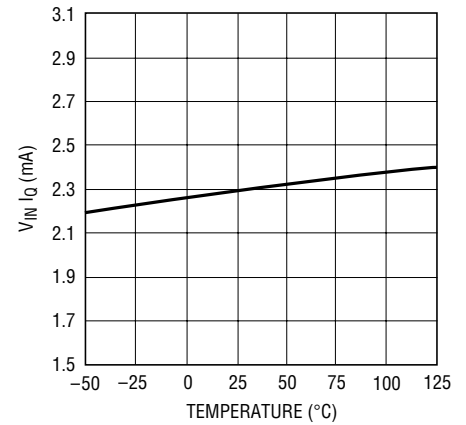

1950 G09

**SHDN Input Current *(-1) vs
Temperature**

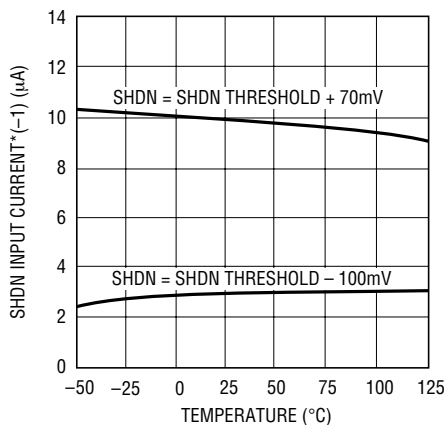

1950 G10

**SHDN Current Hysteresis vs
Temperature**

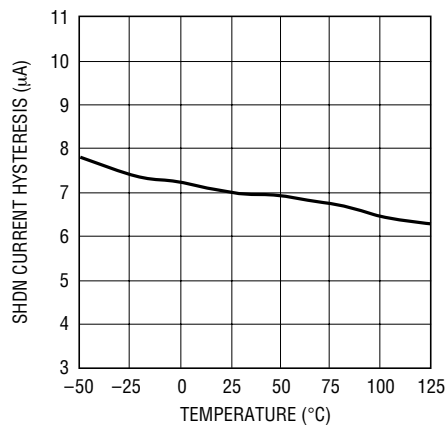

1950 G11

**GATE Rise/Fall Time vs
GATE Capacitance**

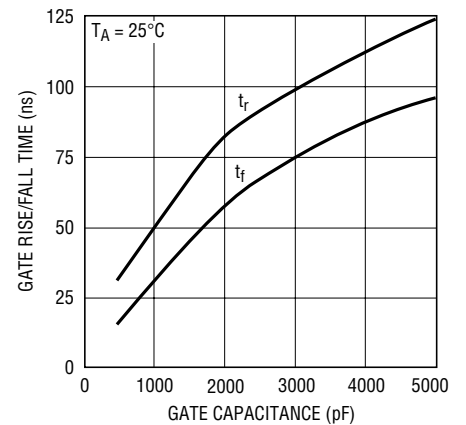

1950 G12

**V_{IN2}: GATE Enable
vs Temperature**

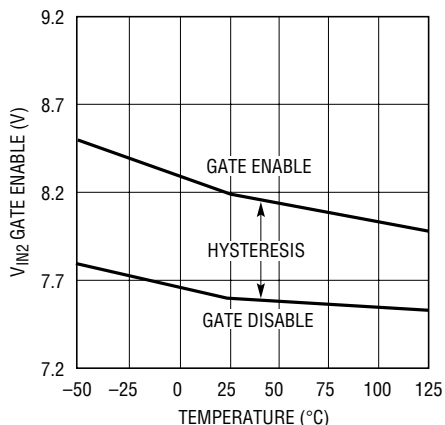

1950 G13

**V_{IN2}: BOOST Disable
vs Temperature**

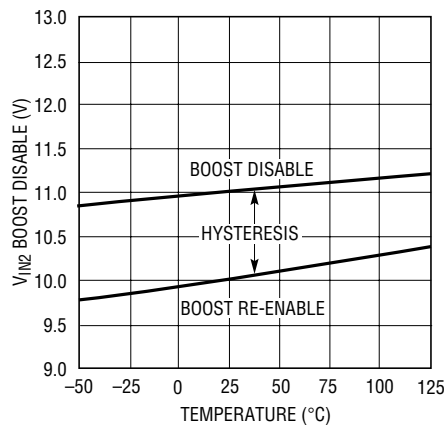

1950 G14

**BOOST Switch I_{LIMIT} vs
Temperature**

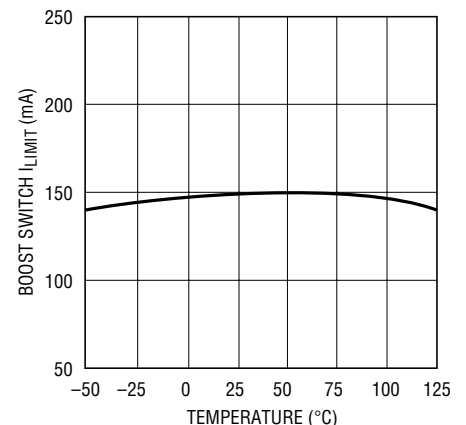

1950 G15

1950fa

TYPICAL PERFORMANCE CHARACTERISTICS

BOOST Switch Off Time vs Temperature

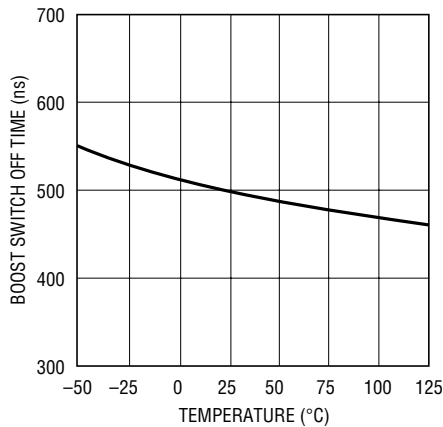

1950 G16

Maximum Duty Cycle vs V_{SEC} Voltage

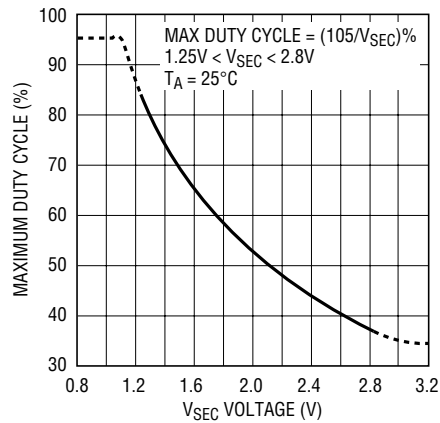

1950 G17

GATE Clamp Voltage vs Temperature

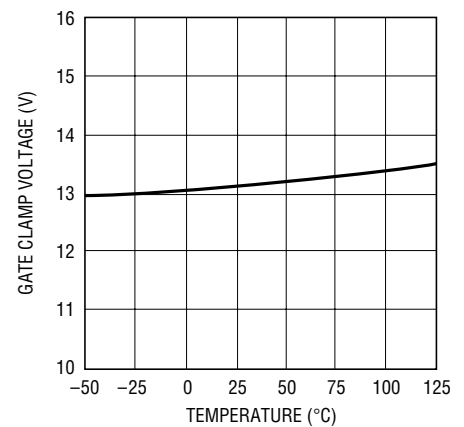

1950 G18

PIN FUNCTIONS

COMP (Pin 1): The COMP pin is the output of the error amplifier. The error amplifier is a true op amp which allows the use of an RC network to be connected between the Comp and FB pins to compensate the feedback loop for optimum transient response. The peak switch current in the external MOSFET will be proportional to the voltage on the COMP pin. Typical operating voltage range for this pin is 1V to 2.5V.

FB (Pin 2): The FB pin is the inverting input to the error amplifier. The output voltage is set with a resistor divider. The error amplifier adjusts the peak switch current to maintain the FB pin voltage at the value of the internal reference voltage of 1.23V.

R_{OSC} (Pin 3): A resistor from the R_{OSC} pin to ground programs the operating frequency of the LT1950. Operating frequency range is 100kHz to 500kHz. Nominal voltage on the R_{OSC} pin is 1V.

SYNC (Pin 4): The SYNC pin is used to synchronize the internal oscillator to an external clock signal. The pin is directly logic compatible and can be driven with any signal with a duty cycle of 10% to 90%. If the SYNC function is not used the pin can be left open circuit or connected to ground.

SLOPE (Pin 5): The SLOPE pin is used to adjust the amount of slope compensation. Leaving the pin open circuit results in a default level of slope compensation. The amount of slope compensation can be adjusted above this default level by connecting a resistor from the SLOPE pin to the V_{REF} pin.

V_{REF} (Pin 6): The V_{REF} pin is the output of an internal 2.5V reference. This pin is capable of sourcing up to 2.5mA for external use. It is recommended that the V_{REF} pin is bypassed to ground with a 0.1μF ceramic capacitor.

SHDN (Pin 7): The SHDN pin is used to put the device into a low power shutdown state. In shutdown the V_{IN} supply current drops to 5μA. The SHDN pin has an accurate threshold of 1.32V which can be used to program an undervoltage lockout threshold. Input current levels on the SHDN pin can be used to program hysteresis into the undervoltage lockout levels.

GND (Pin 8): The GND pin is the analog ground for the internal circuitry of the LT1950. Sensitive circuitry such as the feedback divider, frequency setting resistor, reference bypass capacitor should be tied directly to this pin. See the Applications Information section for recommendations on ground connections.

PIN FUNCTIONS

BLANK (Pin 9): The BLANK pin is used to adjust the leading edge blanking period of the current sense amplifier during FET turn-on. Shorting the BLANK pin to ground provides a default blanking period of approximately 110ns. A resistor from the BLANK pin to ground increases the blanking period up to 290ns for $R_{\text{BLANK}} = 75k$.

I_{SENSE} (Pin 10): The I_{SENSE} pin is the current sense input for the control loop. Connect this pin to the sense resistor in the source of the external power MOSFET.

V_{IN2} (Pin 11): The V_{IN2} pin is the supply pin for the MOSFET gate drive circuit. Power can be supplied to this pin by an external supply such as V_{IN}, and must exceed 8V (the undervoltage lockout threshold for the gate driver supply). For low V_{IN} supply voltages an internal boost regulator can be used to generate as much as 11V at the V_{IN2} pin. This allows the LT1950 to run with V_{IN} supply voltages down to 3V while still supplying enough gate drive for standard level MOSFETs.

GATE (PIN 12): The GATE pin is the output of a high current gate drive circuit used to drive an external MOSFET. The output is actively clamped to a max voltage of 13V if V_{IN2} is supplied by a high voltage.

PGND (Pin 13): This is the ground connection for the high current gate driver stage. See the Applications Information section for recommendations on ground connections.

BOOST (Pin 14): The BOOST pin is the NPN collector output of the internal boost converter which can be used to generate an 11V supply for the MOSFET gate driver circuit. The boost converter runs with a fixed off-time of 0.5 μ s and a current limit of 125mA. The converter runs until the V_{IN2} voltage exceeds 11V and then turns off until the V_{IN2} voltage drops below 10V. If the V_{IN2} voltage is supplied externally, the BOOST pin should be shorted to ground or left open.

V_{IN} (Pin 15): The V_{IN} pin is the main supply pin for the LT1950. This pin must be closely bypassed to ground. If V_{IN2} is generated using the BOOST pin then the LT1950 will be fully functional, internal V_{REF} will be active and the gate output will be enabled with a V_{IN} voltage as low as 3V. An internal undervoltage lockout threshold exists at approximately 2.6V on the V_{IN} pin. Undervoltage lockout voltages greater than 3V can be programmed using a voltage divider on the SHDN pin.

V_{SEC} (Pin 16): The V_{SEC} pin is used to program the maximum duty cycle of the gate driver circuit. The maximum duty cycle will be equal to $(105/V_{\text{SEC}})\%$ for V_{SEC} between 1.4V and 2.8V. This is a useful function to limit the flyback voltage in a forward converter. If the maximum duty cycle function is not used then the V_{SEC} pin should be tied to ground.

BLOCK DIAGRAM

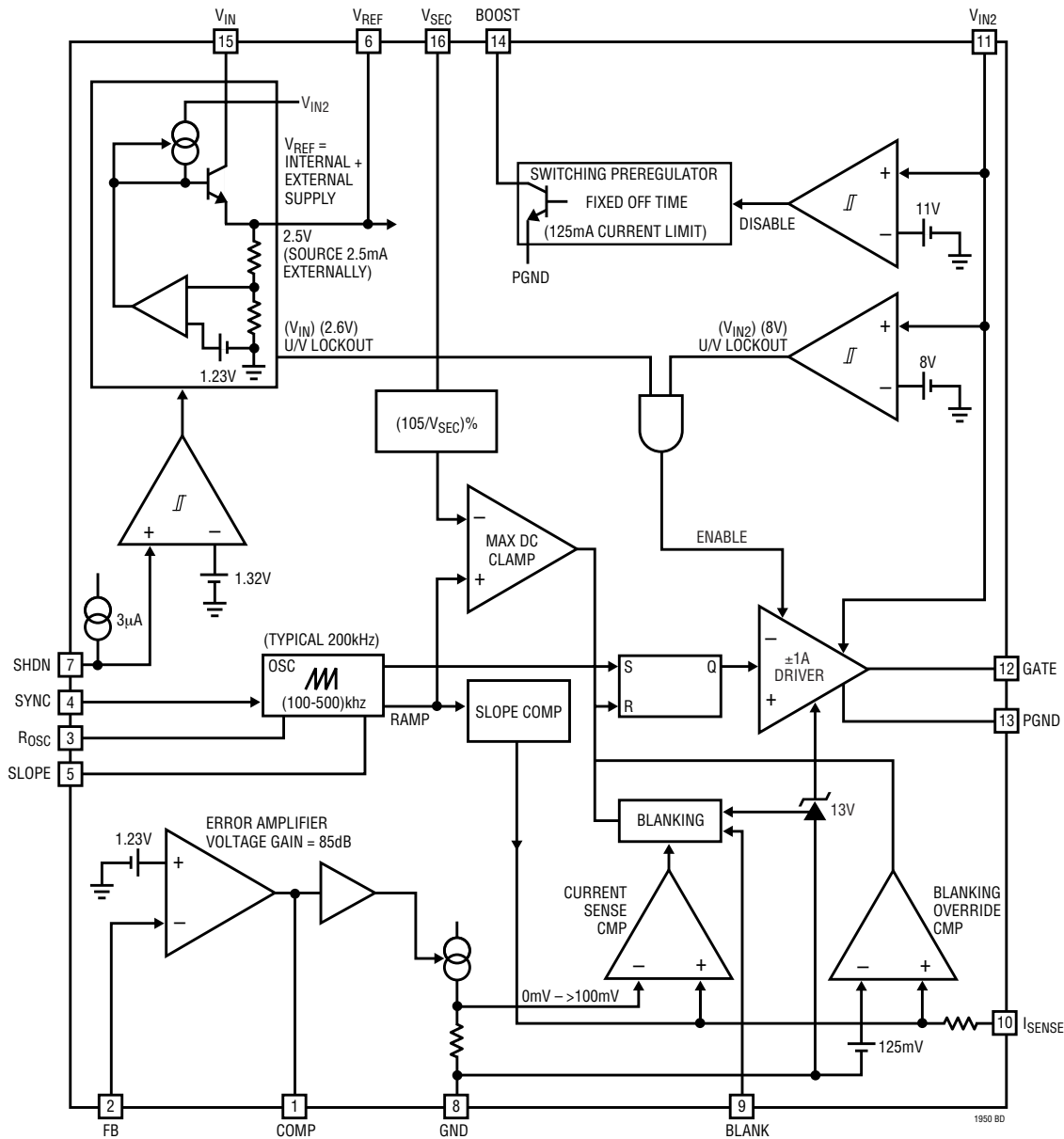

Figure 1. LT1950 Block Diagram

OPERATION

The LT1950 is a constant frequency, current mode controller for DC/DC forward, boost, flyback and SEPIC converter applications. The Block Diagram in Figure 1 shows all of the key functions of the IC.

In normal operation, a V_{IN} voltage as low as 3V allows an internal switcher at the BOOST pin to generate a separate

11V supply at V_{IN2} using a small surface mount external inductor, diode and capacitor. Since V_{IN2} supplies the output driver of the IC, this architecture achieves high GATE drive for an external N-channel power MOSFET even though V_{IN} voltage is very low. High GATE drive capability reduces MOSFET $R_{DS(ON)}$ for improved efficiency,

OPERATION

increases the range of MOSFETs that can be selected and allows applications requiring high gate drive with a large swing in V_{IN} voltage. When V_{IN2} exceeds 8V, the GATE output driver is enabled. The GATE switches between 0V and V_{IN2} at a constant frequency set by a resistor from the R_{OSC} pin to ground. When V_{IN2} reaches 11V, the internal switcher at the BOOST pin is disabled to save power and only re-enabled when V_{IN2} drops below 10V. The internal boost switcher runs in burst mode operation, asynchronous to the main oscillator. If low V_{IN} operation with high GATE drive is not required, the BOOST pin is left open and the V_{IN2} pin shorted to V_{IN} . With V_{IN2} shorted to V_{IN} the minimum operational V_{IN} voltage will increase from 3V to 8V (required at V_{IN2} to enable the GATE output driver). For GATE turn on, a PWM latch is set at the start of each main oscillator cycle. For GATE turn off, the PWM latch is reset when either the current sense comparator is tripped, the maximum duty cycle is reached, or the BLANK override threshold is exceeded.

A resistor divider from the application's output voltage generates a voltage at the FB pin that is compared to the internal 1.23V reference by the error amplifier. The error amplifier output (COMP) defines the input threshold (I_{SENSE}) of the current sense comparator. Maximum I_{SENSE} voltage is clamped to 100mV. By connecting I_{SENSE} to a sense resistor in series with the source of the external MOSFET, the peak switch current is controlled by COMP. An increase in output load current causing the output voltage to fall, will cause COMP to rise, increasing I_{SENSE} threshold, increasing the current delivered to the output.

This current mode technique means that the error amplifier commands current to be delivered to the output rather than voltage. This makes frequency compensation easier and provides faster loop response to output load transients.

The current mode architecture requires slope compensation to be added to the current sensing loop to prevent subharmonic oscillations which can occur for duty cycles above 50%. Unlike most current mode converters which have a slope compensation ramp that is fixed internally, placing a constraint on inductor value and operating frequency, the LT1950 has externally adjustable slope

compensation. A default level of slope compensation is achieved with the SLOPE pin open. Increased slope compensation can be programmed by reducing the value of resistance inserted between the SLOPE pin and V_{REF} pin.

A SYNC pin allows the LT1950 main oscillator to be synchronized to an external clock. To avoid loss of slope compensation during synchronization, the free running main oscillator frequency should be programmed to approximately 80% of the external clock frequency.

The LT1950 can be placed into shutdown mode when the SHDN pin drops below an accurate 1.32V threshold. This threshold can be used to program undervoltage lockout (UVLO) at V_{IN} for current limited or high source resistance supplies. SHDN pin current hysteresis also exists to allow external programming of UVLO voltage hysteresis. When V_{IN} and V_{IN2} exceed internally set UVLO thresholds of 2.6V and 6.8V, the V_{REF} output becomes active. The V_{REF} output is a 2.5V reference supplying the majority of LT1950 control circuitry and capable of sourcing up to 2.5mA for external use.

To prevent noise in the system causing premature turn off of the external MOSFET the LT1950 has leading edge blanking. This means the current sense comparator output is ignored during MOSFET turn on and for an extended period after turn on. The extended blanking period is adjusted by inserting a resistor from the BLANK pin to ground. A short to ground defines a minimum default blanking period. Increased resistance from the BLANK pin to ground will increase blanking duration. Fault conditions causing I_{SENSE} to exceed 125mV will override blanking and reduce the I_{SENSE} to GATE delay to 60ns.

For applications requiring maximum duty cycle clamping, the V_{SEC} pin reduces duty cycle for increased voltage on the pin. The V_{SEC} pin provides a volt-second clamp critical in forward converter applications.

Maximum duty cycle follows $(105/V_{SEC})\%$ for V_{SEC} voltages between 1.4V to 2.8V. If unused, the V_{SEC} pin should be shorted to ground, leaving the natural maximum duty cycle of the part to be typically 95% for 200kHz operation.

APPLICATIONS INFORMATION

LT1950 Input Supplies, V_{REF} Output and GATE Enable

V_{IN} is the main input supply for the LT1950. V_{IN2} is the input supply for the LT1950 output driver. V_{IN2} can be provided by shorting the V_{IN2} pin to the V_{IN} pin or by generating V_{IN2} using the BOOST pin. Waveforms of V_{IN} , V_{IN2} , V_{REF} and GATE switching are shown in Figures 2 and 3. Figure 2 represents low V_{IN} operation with V_{IN2} generated using the BOOST pin. Figure 3 represents $V_{IN} = V_{IN2}$ operation with the BOOST pin open circuit or shorted to ground.

Low V_{IN} Operation

The LT1950 can be configured to provide a minimum of 10V GATE drive for an external N-channel MOSFET from V_{IN} voltages as low as 3V, if the BOOST pin is used to generate a second supply at the V_{IN2} pin (see Figure 2 and Applications Information “Generating V_{IN2} Supply Using BOOST Pin”). The advantage of this configuration is that a lower $R_{DS(ON)}$ is achieved for the external N-channel MOSFET, improving efficiency, versus a controller running at 3V input without boosted gate drive. In addition, typical controllers running at low input voltages have the limitation of only being able to use logic level MOSFETs. The LT1950 allows a greater range of usable MOSFETs. This versatility allows optimization of the overall power supply performance and allows applications which would otherwise not be possible without a more complex topology. Figure 2 shows that for V_{IN} above 2V, the internal switcher at the BOOST pin is enabled. This switcher generates the V_{IN2} supply. As V_{IN2} ramps up above the undervoltage lockout threshold of 6.8V the 2.5V reference V_{REF} becomes active and powers up internal control circuitry. When V_{IN2} exceeds approximately 8V, the gate driver is enabled. V_{IN2} is regulated between 10V and 11V, providing a supply to the LT1950 output driver to ensure a minimum of 10V drive at the GATE pin.

$V_{IN} = V_{IN2}$ Operation

If low V_{IN} operation is not required below approximately 8V on V_{IN} the LT1950 can be configured to run without the use of the BOOST pin by shorting the V_{IN2} pin to the V_{IN} pin. Figure 3 shows that both V_{IN} and V_{IN2} must now exceed 6.8V to activate the 2.5V V_{REF} output and must exceed approximately 8V to enable the output driver (GATE pin).

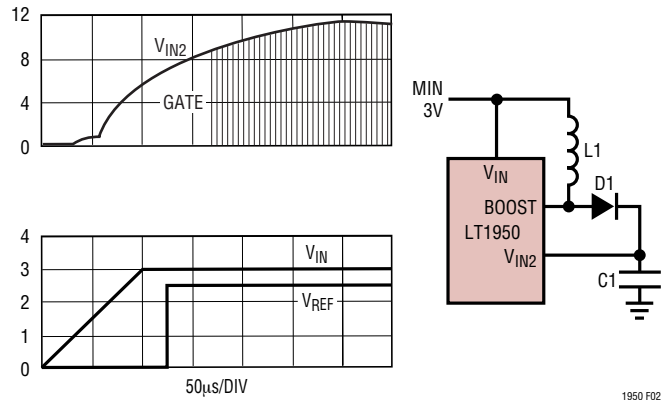

Figure 2. Low V_{IN} Operation

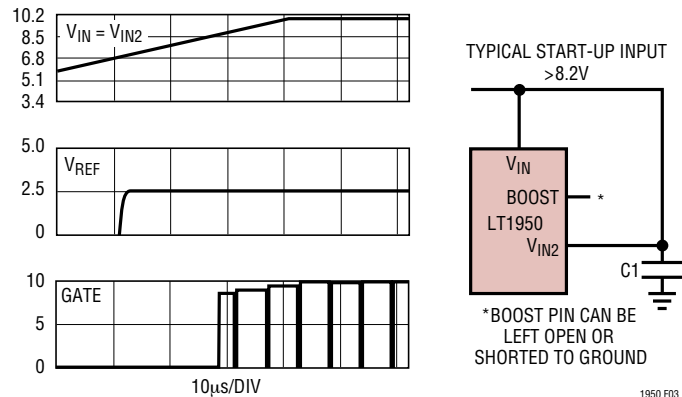

Figure 3. $V_{IN} = V_{IN2}$ Operation

APPLICATIONS INFORMATION

Shutdown and Undervoltage Lockout

Figure 4 shows how to program undervoltage lockout (UVLO) for the V_{IN} supply. Typically, UVLO is used in situations where the input supply is current limited, or has a relatively high source resistance. A switching regulator draws constant power from the source, hence source current increases as source voltage drops. This looks like a negative load resistance to the source and can cause the source to current limit or latch low under low source voltage conditions. An internally set undervoltage lockout (UVLO) threshold prevents the regulator from operating at source voltages where these problems might occur. An internal comparator will force the part into shutdown below the minimum V_{IN} of 2.6V. This feature can be used to prevent excessive discharge of battery-operated systems. Alternatively, UVLO threshold is adjustable. The shutdown threshold voltage of the SHDN pin is 1.32V. Forcing the SHDN pin below this 1.32V threshold causes V_{REF} to be disabled and stops switching at the GATE pin. If the SHDN pin is left open circuit, a permanent 3 μ A flows out of the pin to ensure that the pin defaults high to allow normal operation. Voltages above the 1.32V threshold cause an extra 7 μ A to be sourced out of the pin, providing current hysteresis. This can be used to set voltage hysteresis of the UVLO threshold using the following equations:

$$R1 = \frac{V_H - V_L}{7\mu A}$$

$$R2 = \frac{1.32V}{\frac{(V_H - 1.32V)}{R1} + 3\mu A}$$

V_H = Turn on threshold

V_L = Turn off threshold

Example: switching should not start until the input is above 11V and is to stop if the input falls below 9V.

$$V_H = 11V$$

$$V_L = 9V$$

$$R1 = \frac{11V - 9V}{7\mu A} = 286k$$

$$R2 = \frac{1.32V}{\frac{(11V - 1.32V)}{286k} + 3\mu A} = 36k$$

Keep the connections from the resistors to the SHDN pin short and make sure that the interplane or surface capacitance to the switching nodes are minimized. If high resistance values are used, the SHDN pin should be bypassed with a 1nF capacitor to prevent coupling problems from the switch node.

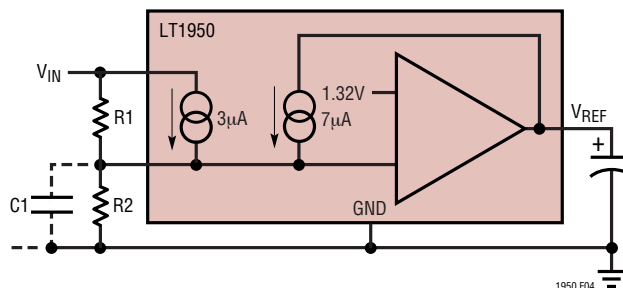

Figure 4. Undervoltage Lockout

Generating V_{IN2} Supply Using BOOST Pin

The LT1950's BOOST pin is used to provide a "boosted" 11V supply at the V_{IN2} pin for V_{IN} voltages as low as 3V. Since V_{IN2} supplies the output driver for the GATE pin of the IC, it is advantageous to generate a boosted V_{IN2} . This architecture achieves high GATE drive for an external

APPLICATIONS INFORMATION

N-channel power MOSFET even though V_{IN} voltage is very low. High GATE drive voltage reduces MOSFET $R_{DS(ON)}$, improves efficiency and increases the range of MOSFETs that can be selected. A small switching regulator at the BOOST pin, with fixed current limit and fixed off time, generates the V_{IN2} supply. With an external inductor connected between the BOOST pin and V_{IN} (see Figure 5), the BOOST pin will draw current until approximately 125mA is reached, turn off for 0.5 μ s and then turn back on. The cycle is repeated for as long as the switcher is enabled. By using a diode connected from BOOST to V_{IN2} and a capacitor from V_{IN2} to ground, energy from the external inductor is transferred to the V_{IN2} capacitor during the off-time of the internal switcher. An auxiliary boost converter is realized providing a supply to the V_{IN2} pin. The typical inductor current, V_{IN2} voltage and BOOST pin voltage waveforms are shown in Figure 5. When V_{IN2} reaches 11V, the internal switcher is disabled. Since V_{IN2} supplies the output driver of the LT1950, switching at the GATE pin will eventually discharge the V_{IN2} capacitor until V_{IN2} reaches a lower level of approximately 10V. At this level the internal switcher is re-enabled and switches until V_{IN2} returns to

11V. This hysteretic (burst mode) operation for the internal switcher minimizes power dissipation from V_{IN} .

The V_{REF} output is a 2.5V reference supplying most of the LT1950 control circuitry. It is available for external use with maximum current capability of 2.5mA. The pin should be bypassed to ground using a 0.1 μ F capacitor. Internal undervoltage lockout thresholds for V_{IN} and V_{IN2} of approximately 2.6V and 6.8V respectively must be exceeded before V_{REF} becomes active.

Programming Oscillator Frequency

The oscillator frequency of the LT1950 is programmed using an external resistor connected between the R_{OSC} pin and ground. Figure 6 shows typical f_{OSC} vs R_{OSC} resistor values. The LT1950 is programmable for a free-running oscillator frequency in the range of 100kHz to 500kHz.

Stray capacitance and potential noise pickup on the R_{OSC} pin should be minimized by placing the R_{OSC} resistor as close as possible to the R_{OSC} pin and keeping the area of the R_{OSC} node as small as possible. The ground side of the R_{OSC} resistor should be returned directly to the GND (analog ground) pin.

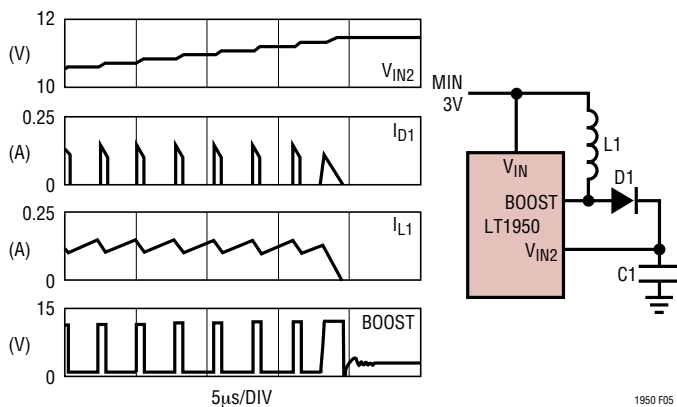

Figure 5. V_{IN2} Generation Using the BOOST Pin

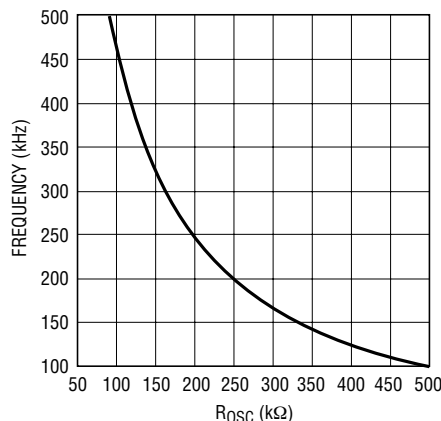

Figure 6. Oscillator Frequency (f_{osc}) vs R_{osc}

APPLICATIONS INFORMATION

Synchronizing

The SYNC pin is used to synchronize the LT1950 main oscillator to an external clock. The SYNC pin can be driven directly from a logic level output, requiring less than 0.8V for a logic level low and greater than 2.2V for a logic level high. Duty cycle must be between 10% and 90%. When synchronizing the part, slope compensation will be reduced by approximately $\text{SYNC} / f_{\text{OSC}}$. If the reduction of slope compensation affects performance, R_{SLOPE} can be reduced to increase slope compensation and reestablish correct operation. If unused, the pin is left open or shorted to ground. If left open, be aware that the internal pin resistance is 20k and board layout should be checked to avoid noise coupling to the pin.

SLOPE COMPENSATION

Programmability

The LT1950 allows its default level of slope compensation to be easily increased by use of a single resistor connected between the SLOPE pin and the V_{REF} pin. The ability to adjust slope compensation allows the designer to tailor his application for a wider inductor value range as well as to optimize the loop bandwidth. A resistor, R_{SLOPE} , connected between the SLOPE pin and V_{REF} increases the LT1950 slope compensation from its default level to as high as 3X of default. The curves in Figure 7 show the typical I_{SENSE} maximum threshold vs duty cycle for various values of R_{SLOPE} . It can be seen that slope compensation subtracts from the maximum I_{SENSE} threshold as duty cycle increases from 0%. For example, with R_{SLOPE} open, I_{SENSE} max threshold is 100mV at low duty cycle, but falls to approximately 86mV at 80% duty cycle. This must be accounted for when designing a converter to operate up to a maximum load current and over a given duty cycle range. The application and inductor value will define the minimum amount of slope compensation. Refer to the

Electrical Characteristics for 1X, 2X and 3X default slope compensation vs R_{SLOPE} .

Requirement in Current Mode Converters/Advantage of Adjustability

The LT1950 uses a current mode architecture to provide fast response to load transients and to ease frequency compensation requirements. Current mode switching regulators which operate with duty cycles above 50% and have continuous inductor current, must add slope compensation to their current sensing loop to prevent subharmonic oscillations. (For more information on slope compensation see Application Note 19). Typical current mode switching regulators have a fixed internal slope compensation. This can place constraints on the value of the inductor. If too large an inductor is used, the fixed internal slope compensation will be greater than needed, causing operation to approach voltage mode. If too small an inductor is used, the fixed internal slope compensation will be too small, resulting in subharmonic oscillations. The LT1950 increases the range of usable inductor values by allowing slope compensation to be adjusted externally.

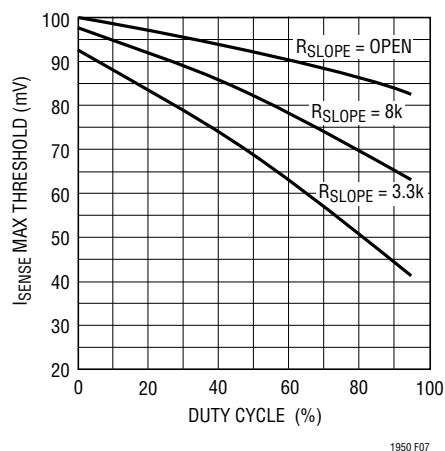

Figure 7. I_{SENSE} Maximum Threshold vs Duty Cycle

APPLICATIONS INFORMATION

Programming Leading Edge Blank Time

For PWM controllers driving external MOSFETs, noise can be generated during GATE rise time due to various parasitic effects. This noise can disturb the input to the current sense comparator (I_{SENSE}) and cause premature turn-off of the external MOSFET. The LT1950 provides programmable leading edge blanking of the current sense comparator to avoid this effect.

Blanking is provided in 2 phases: The first phase is during GATE rise time. GATE rise times vary depending on MOSFET type. For this reason the LT1950 automatically blanks the current comparator output until the “leading edge” of the GATE is detected. This occurs when the GATE voltage has risen within 0.5V of the output driver supply (V_{IN2}) or has reached its clamp level of 13V. The second phase of blanking starts immediately after “leading edge” has been detected. This phase is programmable using a resistor (R_{BLANK}) from the BLANK pin to ground. Typical values for this portion of the blanking period are 110ns at $R_{BLANK} = 0\Omega$ up to 290ns at $R_{BLANK} = 75k$. Figure 8 shows blanking vs R_{BLANK} . Blanking duration can be approximated as:

$$BLANKING (EXTENDED) = 110 + \left(60 \cdot \frac{R_{BLANK}}{25k} \right) ns$$

Programming Volt-Second Clamp

The V_{SEC} pin is used to provide an adaptive maximum duty cycle clamp for sophisticated control of the simplest forward converter topology (single primary-side switch). This adaptive maximum duty cycle clamp allows the use of the smallest transformers, MOSFETs and output rectifiers by addressing the biggest concern in single switch forward converter topologies - transformer reset. The section “Application Circuits-Forward Converter Applications” covers transformer reset requirements and highlights the advantages of the LT1950 adaptive maximum duty cycle clamp. The programmable maximum duty cycle clamp is controlled by the voltage on the V_{SEC} pin. As voltage on the V_{SEC} pin increases within a specified range, maximum duty cycle decreases. By deriving V_{SEC} pin voltage from the system input supply, a volt-second clamp is realized. Maximum GATE output duty cycle follows a 1/X relationship given by $(105/V_{SEC})\%$. (see Maximum Duty Cycle vs V_{SEC} Voltage graph in the Typical Performance Characteristics section). For example, if the minimum input supply for a forward converter application is 36V, the V_{SEC} pin can be programmed with a maximum duty cycle of 75% at 1.4V. A movement of input voltage to 72V will lift the V_{SEC} pin to 2.8V, resulting in a maximum duty cycle of 37.5%. As the section on Forward Converter Applications will show, transformer reset requirements are met with the

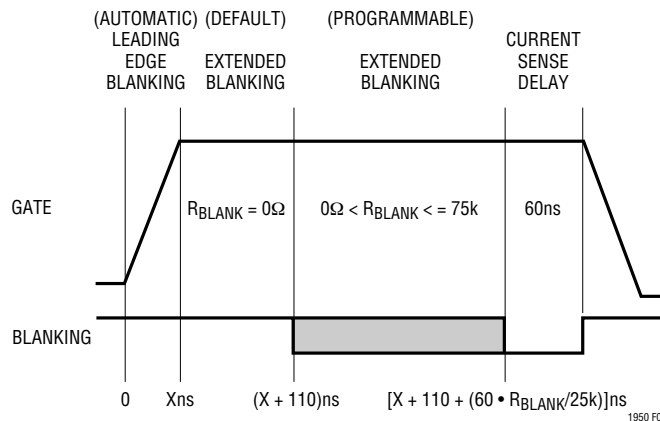

Figure 8. Blanking Timing Diagram

APPLICATIONS INFORMATION

ability of the V_{SEC} pin to follow input voltage and control maximum switch duty cycle.

Forward Converter Applications

The LT1950 provides sophisticated control of the simplest forward converter topology (single primary switch, see Q1 Figure 11). A significant problem in a single switch forward converter topology is transformer reset. Optimum transformer utilization requires maximum duty cycles. Unfortunately as duty cycles increase the transformer reset time decreases and reset voltages increase. This increases the voltage requirements and stress on both transformer and switch. The LT1950 incorporates an adaptive maximum duty cycle clamp which controls maximum switch duty cycle based on system input voltage. The adaptive clamp allows the converter to operate at up to 75% duty cycle, allowing 25% of the switching period for resetting the transformer. This results in greater utilization of MOSFET, transformer and output rectifier components. The V_{SEC} pin can be programmed from system input to adaptively control maximum duty cycle (see Applications Information “Programming Volt-Second Clamp” and the Maximum Duty Cycle vs V_{SEC} Voltage graph in the Typical Performance Characteristics section).

94% Efficient 3.3V, 20A Synchronous Forward Converter

The synchronous forward converter in Figure 11 is based on the LT1950 and uses MOSFETs as synchronous output rectifiers to provide an efficient 3.3V, 20A isolated output from 48V input. The output rectifiers are driven by the LTC1698 which also serves as an error amplifier and optocoupler driver. Efficiency and transient response are shown in Figures 9 and 10. Peak efficiencies of 94% and ultra-fast transient response are superior to presently available power modules. In addition, the circuit in Figure 11 is an all-ceramic capacitor solution providing low output ripple voltage and improved reliability. The LT1950-based converter can be used to replace power module converters at a much lower cost. The LT1950 solution benefits from thermal conduction of the system board resulting in higher efficiencies and lower rise in component temperatures. The 7mm height allows dense packaging and the circuit can be easily adjusted to provide an output voltage from 1.23V to 15V. In addition, higher currents are achievable by simple scaling of power components. The LT1950-based solution in Figure 11 is a powerful topology for replacement of a wide range of power modules.

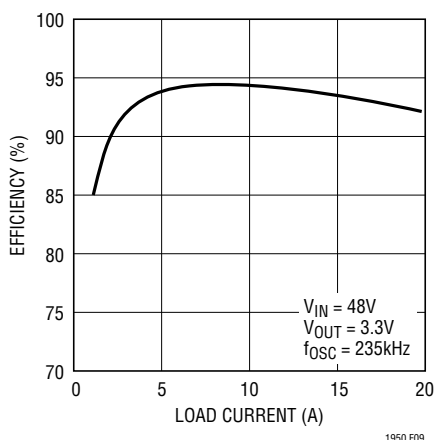

Figure 9. LT1950-Based Synchronous Forward Converter Efficiency vs Load Current

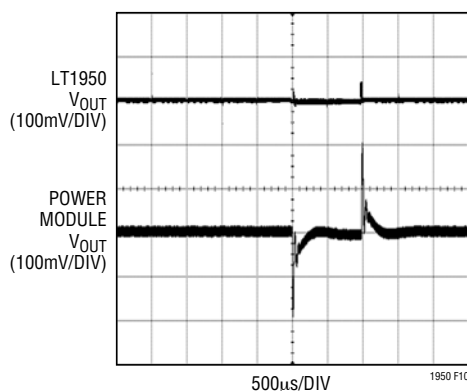

Figure 10. Output Voltage Transient Response to Load Steps (0A to 3.3A) LT1950 (Trace 1) vs Power Module (Trace 2)

APPLICATIONS INFORMATION

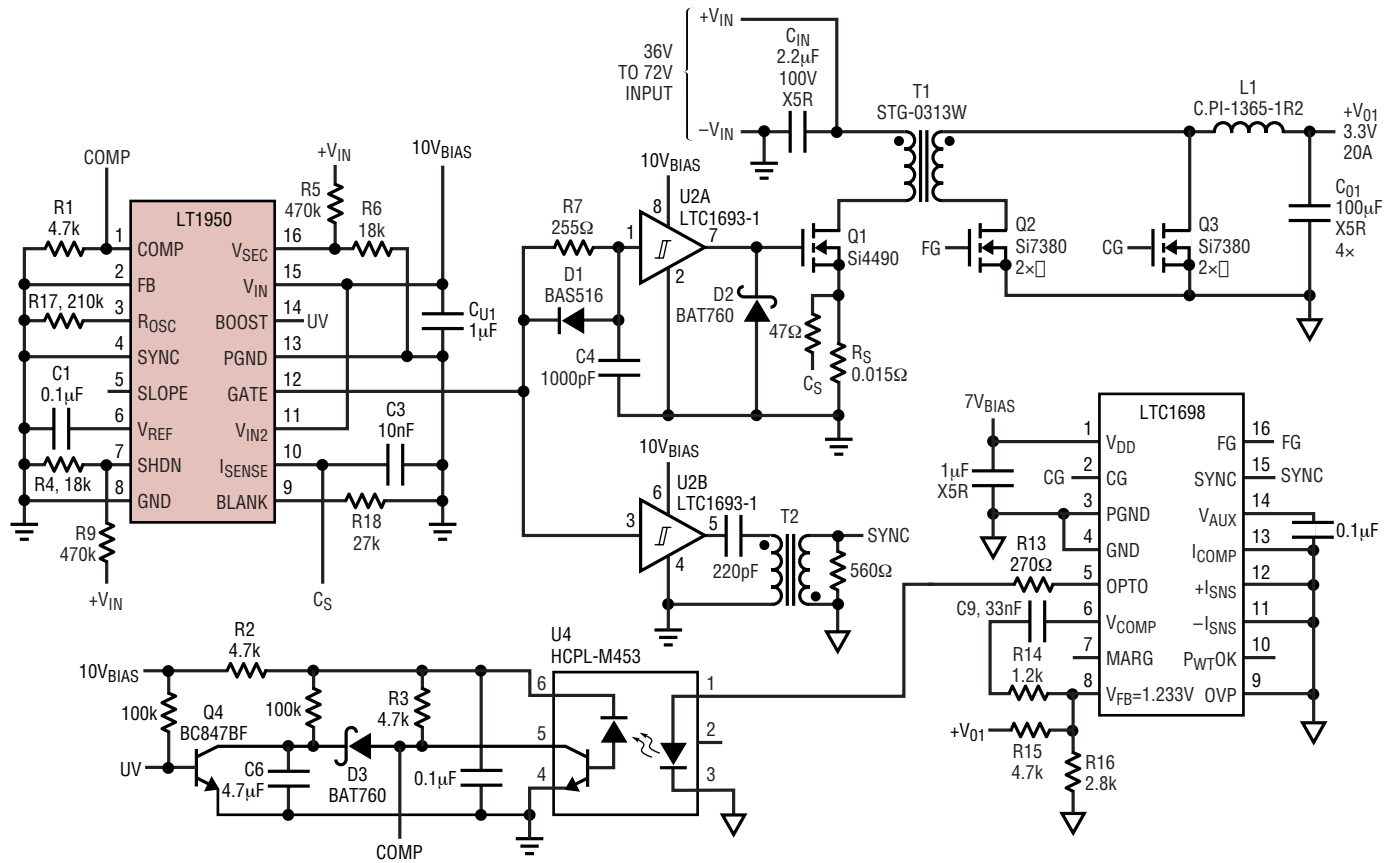

Figure 11. 36V to 72V Input to 3.3V at 20A Synchronous Forward Converter

APPLICATIONS INFORMATION

High Efficiency, Isolated 26V 5A Output, Nonsynchronous Forward Converter

Figure 13 illustrates a nonsynchronous forward converter based on the LT1950 to provide a highly efficient, 26V 5A isolated output from 48V input. The LT1950-based converter using a single switch topology and utilizing the LT1950s adaptive maximum duty cycle clamp is a simple and highly optimized solution. Peak efficiencies of 92.8% (Figure 12) are achievable. Transformer and inductor are standard components. The quarter brick sized DC/DC converter (2.3" by 1.45") delivers over 125W and is only 0.4" high. The 26V converter can be used as a “front line” (isolating) converter in telecom systems with multiple outputs.

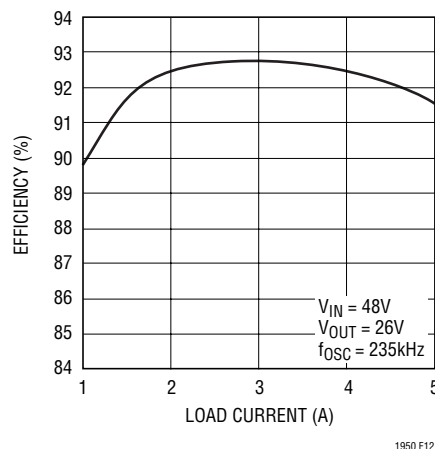

Figure 12. LT1950-Based Nonsynchronous Forward Converter Efficiency vs Load Current (Figure 13 Circuit)

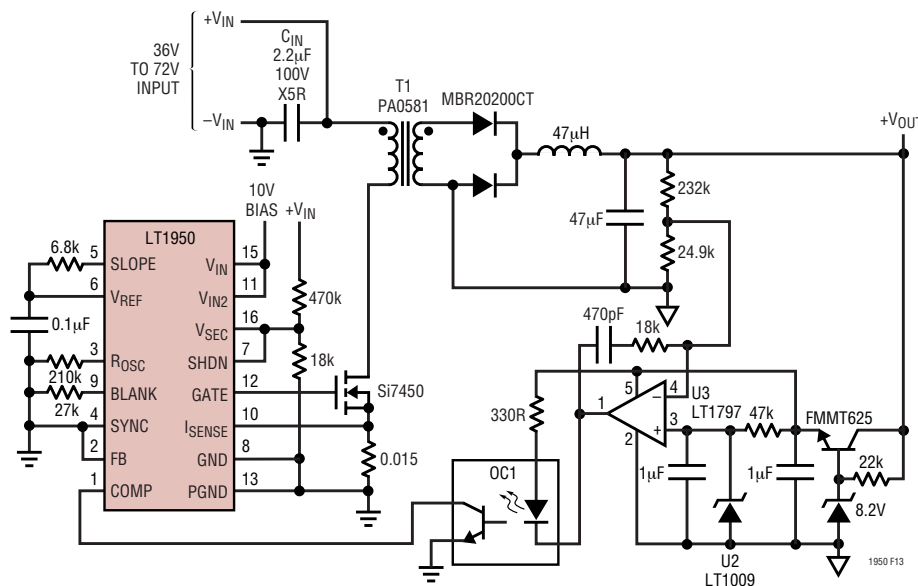

Figure 13. 36V to 72V Input to 26V at 5A Nonsynchronous Forward Converter

APPLICATIONS INFORMATION

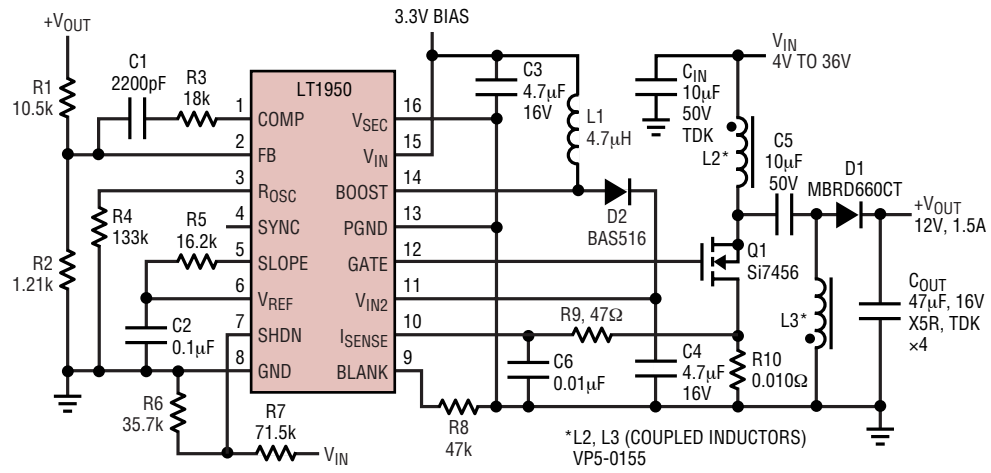
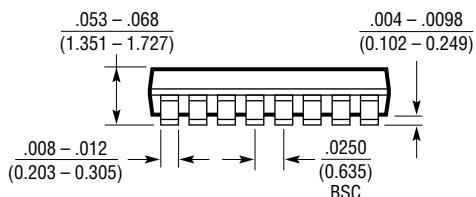
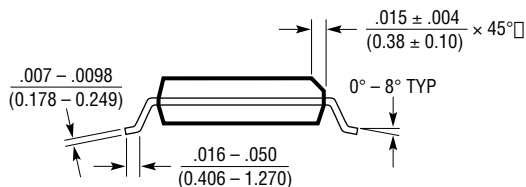
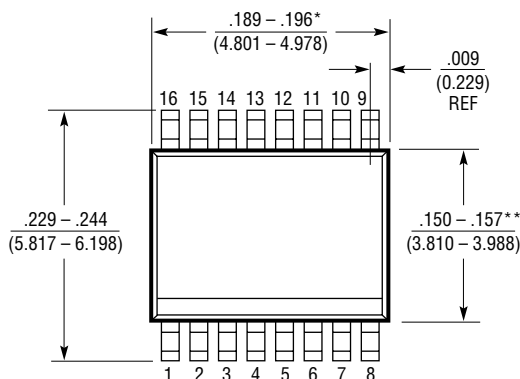
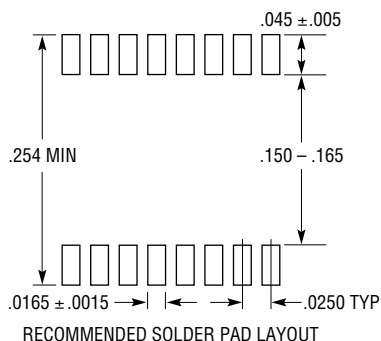

Figure 14. 4V to 36V Input, 12V/1.5A Automotive SEPIC Converter

PACKAGE DESCRIPTION

GN Package 16-Lead Plastic SSOP (Narrow .150 Inch) (Reference LTC DWG # 05-08-1641)



NOTE:

1. CONTROLLING DIMENSION: INCHES
2. DIMENSIONS ARE IN $\frac{\text{INCHES}}{\text{MILLIMETERS}}$
3. DRAWING NOT TO SCALE

*DIMENSION DOES NOT INCLUDE MOLD FLASH. MOLD FLASH SHALL NOT EXCEED 0.006" (0.152mm) PER SIDE

**DIMENSION DOES NOT INCLUDE INTERLEAD FLASH. INTERLEAD FLASH SHALL NOT EXCEED 0.010" (0.254mm) PER SIDE

GN16 (SSOP) 0502

RELATED PARTS

PART NUMBER	DESCRIPTION	COMMENTS
LT1534	Ultralow Noise 2A Switching Regulator	Reduces Conducted and Radiated EMI, Low Switching Harmonics, 20kHz to 250kHz Switching Frequency
LT1619	Low Voltage Current Mode Controller	$1.9V \leq V_{IN} \leq 18V$, 300kHz Operation, Boost, Flyback, SEPIC
LT1681/LT3781	Dual Transistor Synchronous Forward Controller	Operation Up to 72V Maximum
LTC1693	High Speed MOSFET Driver	1.5A Peak Output Current, 16ns Rise/Fall Time at $V_{CC} = 12V$, $C_L = 1nF$
LTC1698	Secondary Synchronous Rectifier Controller	Use with the LT1950 or LT1681, Isolated Power Supplies, Contains Voltage Margining, Optocoupler Driver, Synchronization Circuit with the Primary Side
LT1725	General Purpose Isolated Flyback Controller	No Optoisolator Required, Accurate Regulation Without User Trims, 50kHz to 250kHz Switching Frequency, SSOP-16 Package
LTC1871	Wide Input Range, No R_{SENSE} ™ Controller	Operation as Low as 2.5V Input, Boost, Flyback, SEPIC
LT1910	Protected High Side MOSFET Driver	8V to 48V Supply Range, Protected -15V to 60V Supply Transient
LTC3440	Micropower Buck-Boost DC/DC Converter	Synchronous, Single Inductor, No Schottky Diode Required
LTC3704	Positive-to-Negative DC/DC Controller	$2.5V \leq V_{IN} \leq 36V$, No R_{SENSE} Current Mode Operation, Excellent Transient Response

No R_{SENSE} is a trademark of Linear Technology Corporation.