



preliminary

Schottky Diode Gen ²

V_{RRM}	=	100 V
I_{FAV}	=	10 A
V_F	=	0.71 V

High Performance Schottky Diode
 Low Loss and Soft Recovery
 Single Diode

Part number

DSA10I100PM

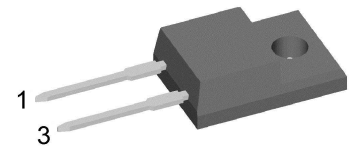

Backside: isolated

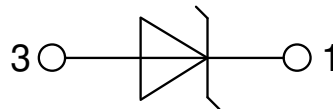
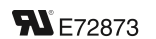

Features / Advantages:

- Very low V_f
- Extremely low switching losses
- Low I_{rm} values
- Improved thermal behaviour
- High reliability circuit operation
- Low voltage peaks for reduced protection circuits
- Low noise switching

Applications:

- Rectifiers in switch mode power supplies (SMPS)
- Free wheeling diode in low voltage converters

Package: TO-220FP

- Isolation Voltage: 2500 V~
- Industry standard outline
- RoHS compliant
- Epoxy meets UL 94V-0
- Soldering pins for PCB mounting
- Base plate: Plastic overmolded tab
- Reduced weight

Disclaimer Notice

Information furnished is believed to be accurate and reliable. However, users should independently evaluate the suitability of and test each product selected for their own applications. Littelfuse products are not designed for, and may not be used in, all applications. Read complete Disclaimer Notice at www.littelfuse.com/disclaimer-electronics.



Schottky				Ratings			
Symbol	Definition	Conditions		min.	typ.	max.	Unit
V_{RSM}	max. non-repetitive reverse blocking voltage					100	V
V_{RRM}	max. repetitive reverse blocking voltage					100	V
I_R	reverse current, drain current	$V_R = 100\text{ V}$		$T_{VJ} = 25^\circ\text{C}$		200	μA
		$V_R = 100\text{ V}$		$T_{VJ} = 125^\circ\text{C}$		2	mA
V_F	forward voltage drop	$I_F = 10\text{ A}$		$T_{VJ} = 25^\circ\text{C}$		0.89	V
		$I_F = 20\text{ A}$				1.04	V
		$I_F = 10\text{ A}$		$T_{VJ} = 125^\circ\text{C}$		0.71	V
		$I_F = 20\text{ A}$				0.87	V
I_{FAV}	average forward current	$T_C = 140^\circ\text{C}$		$T_{VJ} = 175^\circ\text{C}$		10	A
		rectangular	$d = 0.5$				
V_{F0}	threshold voltage			$T_{VJ} = 175^\circ\text{C}$		0.45	V
r_F	slope resistance	} for power loss calculation only				16.1	m Ω
R_{thJC}	thermal resistance junction to case					4.5	K/W
R_{thCH}	thermal resistance case to heatsink				0.5		K/W
P_{tot}	total power dissipation			$T_C = 25^\circ\text{C}$		35	W
I_{FSM}	max. forward surge current	$t = 10\text{ ms}; (50\text{ Hz}), \text{ sine}; V_R = 0\text{ V}$		$T_{VJ} = 45^\circ\text{C}$		240	A
C_J	junction capacitance	$V_R = 12\text{ V}$ $f = 1\text{ MHz}$		$T_{VJ} = 25^\circ\text{C}$		96	pF



Package TO-220FP		Ratings				
Symbol	Definition	Conditions	min.	typ.	max.	Unit
I_{RMS}	RMS current	per terminal			35	A
T_{VJ}	virtual junction temperature		-55		175	°C
T_{op}	operation temperature		-55		150	°C
T_{stg}	storage temperature		-55		150	°C
Weight				2		g
M_D	mounting torque		0.4		0.6	Nm
F_C	mounting force with clip		20		60	N
$d_{Spp/ App}$	creepage distance on surface striking distance through air	terminal to terminal	3.2	2.7		mm
$d_{Spb/ Apb}$		terminal to backside	2.5	2.5		mm
V_{ISOL}	isolation voltage	t = 1 second	2500			V
		t = 1 minute	2100			V

Product Marking

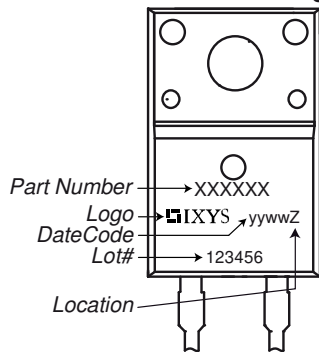

Part description

- D = Diode
- S = Schottky Diode
- A = low VF
- 10 = Current Rating [A]
- I = Single Diode
- 100 = Reverse Voltage [V]
- PM = TO-220ACFP (2)

Ordering	Ordering Number	Marking on Product	Delivery Mode	Quantity	Code No.
Standard	DSA10I100PM	DSA10I100PM	Tube	50	503362

Equivalent Circuits for Simulation

* on die level

$T_{VJ} = 175^{\circ}C$



Schottky

$V_{0\ max}$	threshold voltage	0.45	V
$R_{0\ max}$	slope resistance *	12.9	mΩ



Outlines TO-220FP

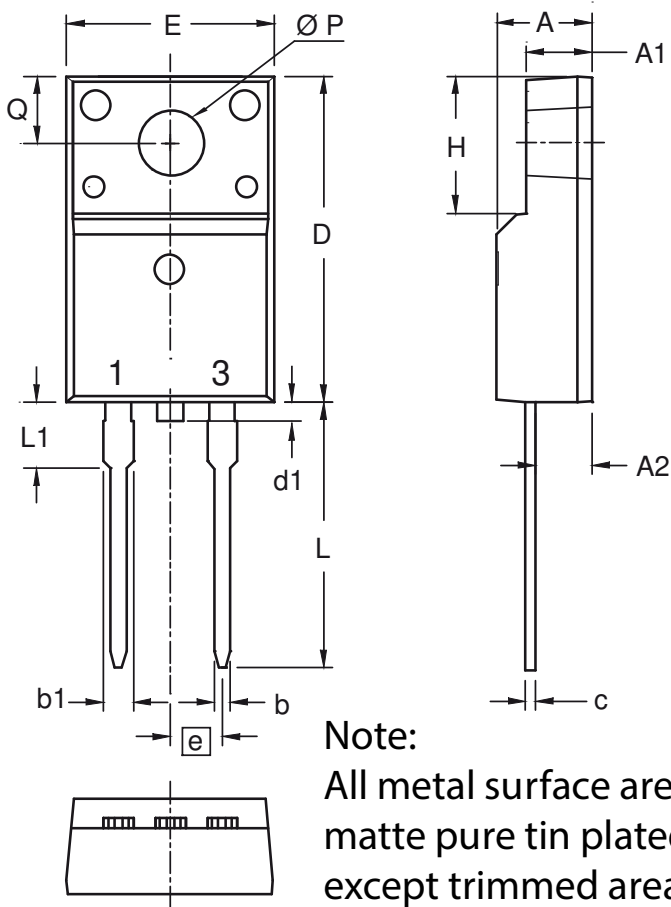

Dim.	Millimeters		Inches	
	min	max	min	max
A	4.50	4.90	0.177	0.193
A1	2.34	2.74	0.092	0.108
A2	2.56	2.96	0.101	0.117
b	0.70	0.90	0.028	0.035
b1	1.27	1.47	0.050	0.058
c	0.45	0.60	0.018	0.024
D	15.67	16.07	0.617	0.633
d1	0	1.10	0	0.043
E	9.96	10.36	0.392	0.408
e	2.54 BSC		0.100 BSC	
H	6.48	6.88	0.255	0.271
L	12.68	13.28	0.499	0.523
L1	3.03	3.43	0.119	0.135
ØP	3.08	3.28	0.121	0.129
Q	3.20	3.40	0.126	0.134

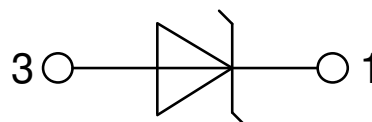



Schottky

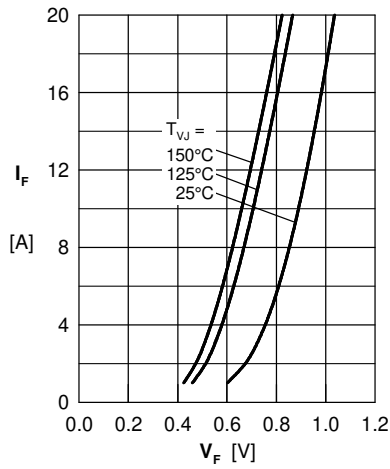

Fig. 1 Maximum forward voltage drop characteristics

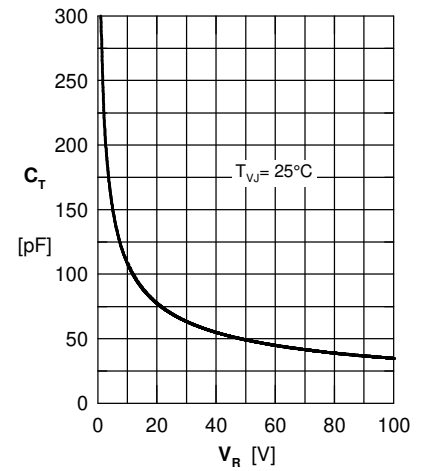

Fig. 3 Typ. junction capacitance C_T vs. reverse voltage V_R

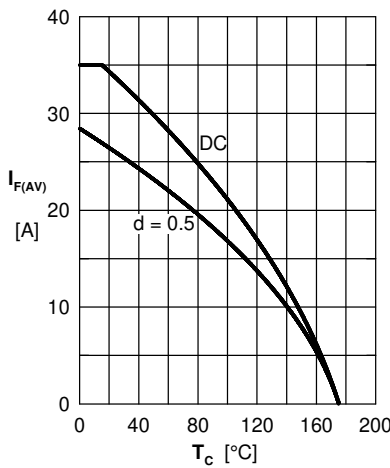

Fig. 4 Avg: forward current $I_{F(AV)}$ vs. case temperature T_C

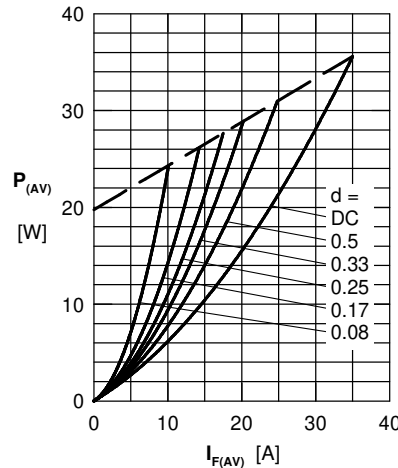

Fig. 5 Forward power loss characteristics

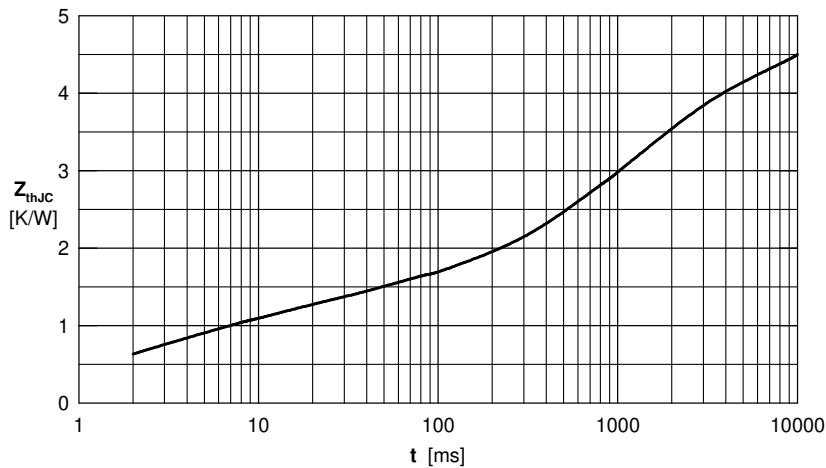

Fig. 6 Transient thermal impedance junction to case