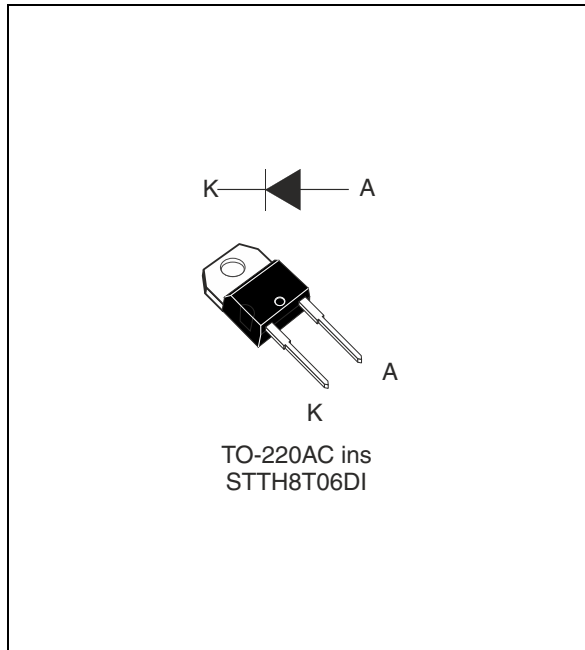

600 V tandem extra fast diode

Datasheet – production data

Table 1. Device summary

Symbol	Value
$I_{F(AV)}$	8 A
V_{RRM}	600 V
t_{rr} (typ)	15 ns
I_{RM} (typ)	2.3 A
V_F (typ)	2.05 V
I_{FRM}	40 A
T_j (max)	175 °C

Features

- High voltage rectifier
- Tandem diodes in series
- Very low switching losses
- Insulated device with internal ceramic
- Equal thermal conditions for both 300 V diodes
- Static and dynamic equilibrium of internal diodes are warranted by design
- Insulated package:
 - Capacitance: 7 pF
 - Insulated voltage: 2500 V rms

Description

This device is part of ST's second generation of 600 V tandem diodes. It has ultralow switching losses with a minimized Q_{RR} (6 nC) that makes it perfect for use in circuits working in hard-switching mode. In particular the V_F/Q_{RR} trade-off positions this device between standard ultrafast diodes and silicon-carbide Schottky rectifiers in terms of price/performance ratio.

The device offers a new positioning giving more flexibility to power-circuit designers looking for good performance while still respecting cost constraints.

Featuring ST's Turbo 2 600 V technology, the device is particularly suited as a boost diode in continuous conduction mode power factor correction circuits.

1 Characteristics

Table 2. Absolute ratings (limiting values at $T_j = 25\text{ °C}$, unless otherwise specified)

Symbol	Parameter		Value	Unit
V_{RRM}	Repetitive peak reverse voltage	T_j from 25 to 150 °C	600	V
		$T_j = -40\text{ °C}$	550	
$I_{F(RMS)}$	Forward rms current		14	A
$I_{F(AV)}$	Average forward current, $\delta = 0.5$	$T_c = 100\text{ °C}$	8	A
I_{FSM}	Surge non repetitive forward current	$t_p = 10\text{ ms}$ sinusoidal	80	A
I_{FRM}	Repetitive peak forward current	$T_c = 100\text{ °C}$, $\delta = 0.1$	40	A
T_{stg}	Storage temperature range		-65 to +175	°C
T_j	Operating junction temperature		-40 to +175	°C

Table 3. Thermal parameters

Symbol	Parameter	Value	Unit
$R_{th(j-c)}$	Junction to case	2.8	°C/W

Table 4. Static electrical characteristics

Symbol	Parameter	Test conditions		Min.	Typ.	Max.	Unit
$I_R^{(1)}$	Reverse leakage current	$T_j = 25\text{ °C}$	$V_R = V_{RRM}$			10	μA
		$T_j = 125\text{ °C}$			30	300	
$V_F^{(2)}$	Forward voltage drop	$T_j = 25\text{ °C}$	$I_F = 8\text{ A}$		2.95		V
		$T_j = 150\text{ °C}$			2.05	2.55	

1. Pulse test: $t_p = 5\text{ ms}$, $\delta < 2\%$
2. Pulse test: $t_p = 380\text{ }\mu\text{s}$, $\delta < 2\%$

To evaluate the conduction losses use the following equation:

$$P = 1.75 \times I_{F(AV)} + 0.10 I_{F(RMS)}^2$$

Table 5. Dynamic characteristics

Symbol	Parameter	Test conditions		Min.	Typ.	Max.	Unit
t_{rr}	Reverse recovery time	$T_j = 25\text{ }^\circ\text{C}$	$I_F = 1\text{ A}, V_R = 30\text{ V},$ $di_F/dt = -50\text{ A}/\mu\text{s}$		23	30	ns
			$I_F = 8\text{ A}, V_R = 400\text{ V},$ $di_F/dt = -200\text{ A}/\mu\text{s}$		15	20	
		$T_j = 125\text{ }^\circ\text{C}$	$I_F = 8\text{ A}, V_R = 400\text{ V},$ $di_F/dt = -200\text{ A}/\mu\text{s}$		22		
I_{RM}	Reverse recovery current	$T_j = 25\text{ }^\circ\text{C}$	$I_F = 8\text{ A}, V_R = 400\text{ V},$ $di_F/dt = -200\text{ A}/\mu\text{s}$		0.8	1.1	A
		$T_j = 125\text{ }^\circ\text{C}$			2.3	3	
S	Softness factor	$T_j = 25\text{ }^\circ\text{C}$			1.6		-
		$T_j = 125\text{ }^\circ\text{C}$			0.8		
Q_{RR}	Reverse recovery charge	$T_j = 25\text{ }^\circ\text{C}$			6	nC	
		$T_j = 125\text{ }^\circ\text{C}$			28		

Figure 1. Average forward power dissipation versus average forward current

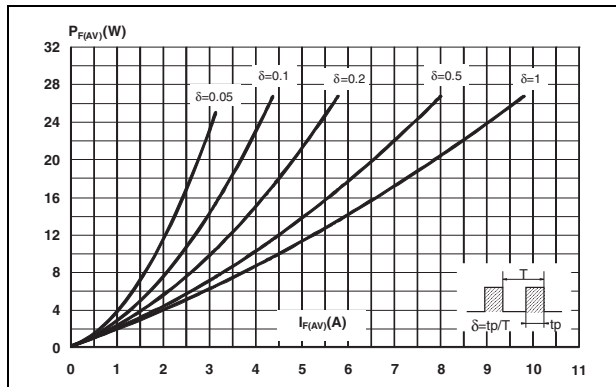

Figure 3. Relative variation of thermal impedance, junction to case, versus pulse duration

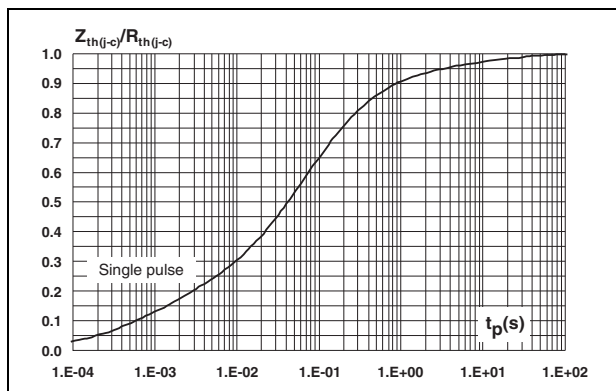

Figure 2. Forward voltage drop versus forward current (typical values)

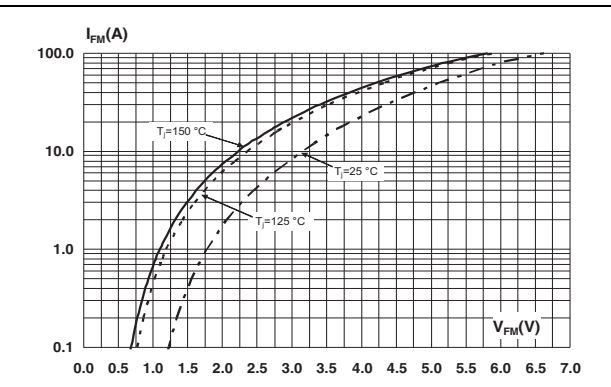

Figure 4. Peak reverse recovery current versus di_F/dt (typical values)

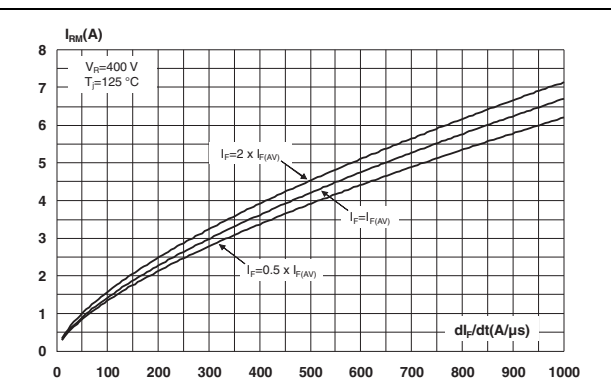

Figure 5. Reverse recovery time versus di_F/dt (typical values)

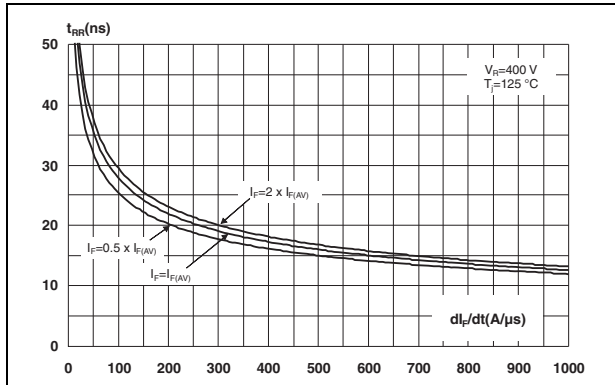

Figure 6. Reverse recovery charges versus di_F/dt (typical values)

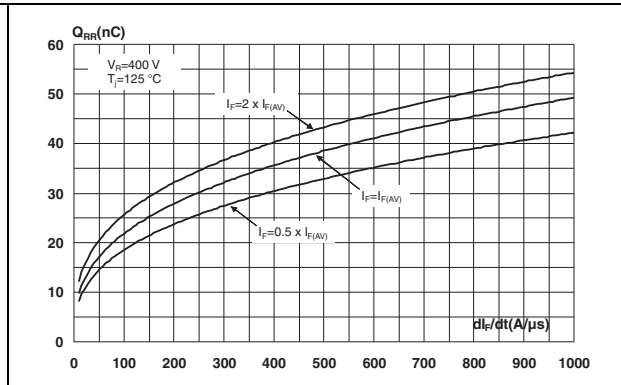

Figure 7. Reverse recovery softness factor versus di_F/dt (typical values)

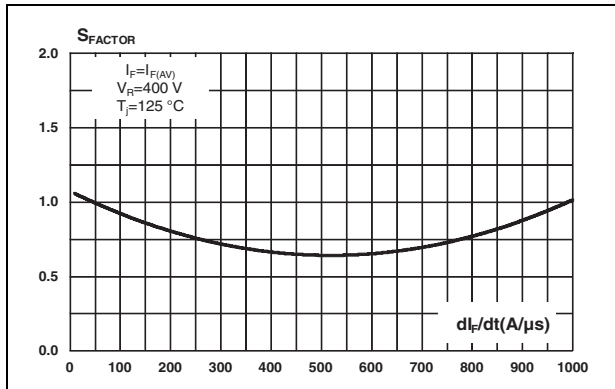

Figure 8. Relative variations of dynamic parameters versus junction temperature

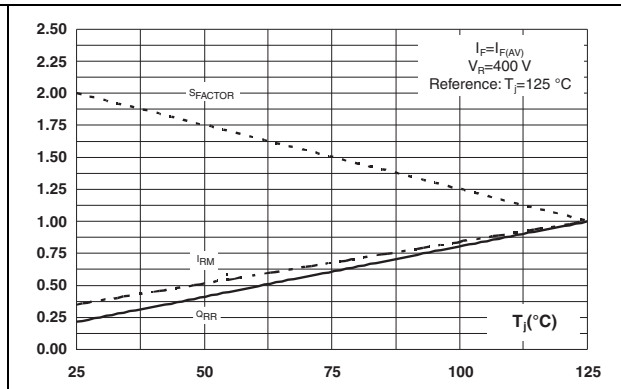

Figure 9. Junction capacitance versus reverse voltage applied (typical values)

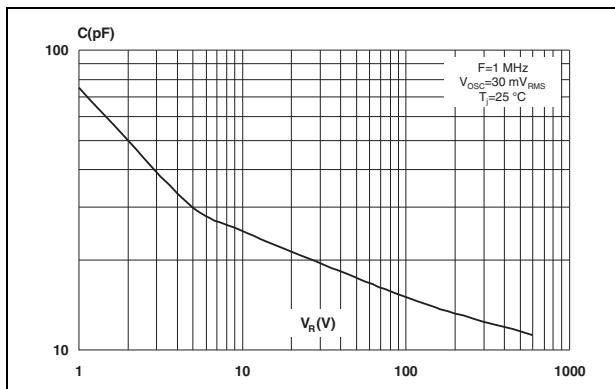

Figure 10. Relative variation of non-repetitive peak surge forward current versus pulse duration

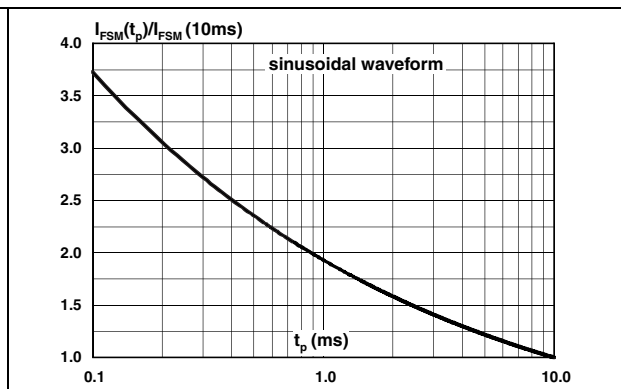
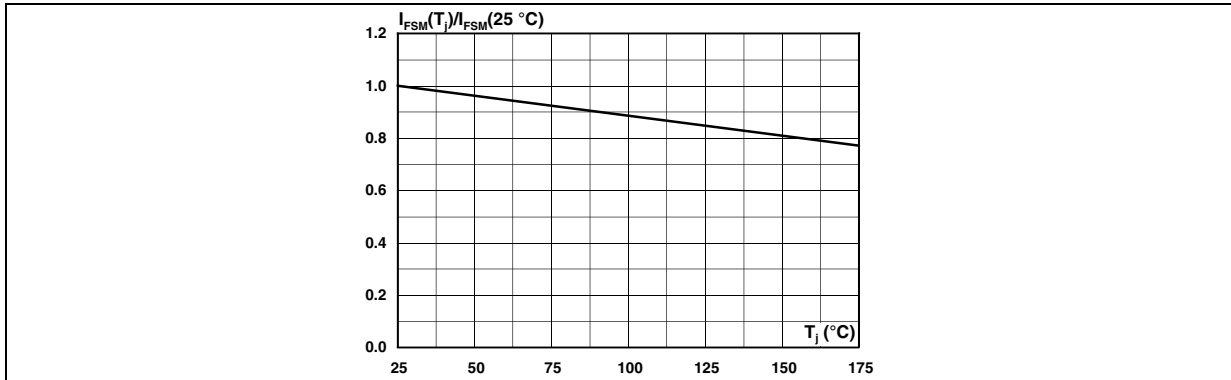

Figure 11. Relative variation of non-repetitive peak surge forward current versus initial junction temperature (sinusoidal waveform)



2 Package information

- Epoxy meets UL94, V0
- Cooling method: by conduction (C)
- Recommended torque: 0.4 to 0.6 N·m

In order to meet environmental requirements, ST offers these devices in different grades of ECOPACK[®] packages, depending on their level of environmental compliance. ECOPACK[®] specifications, grade definitions and product status are available at: www.st.com. ECOPACK[®] is an ST trademark.

Figure 12. T0-220AC ins dimension definitions

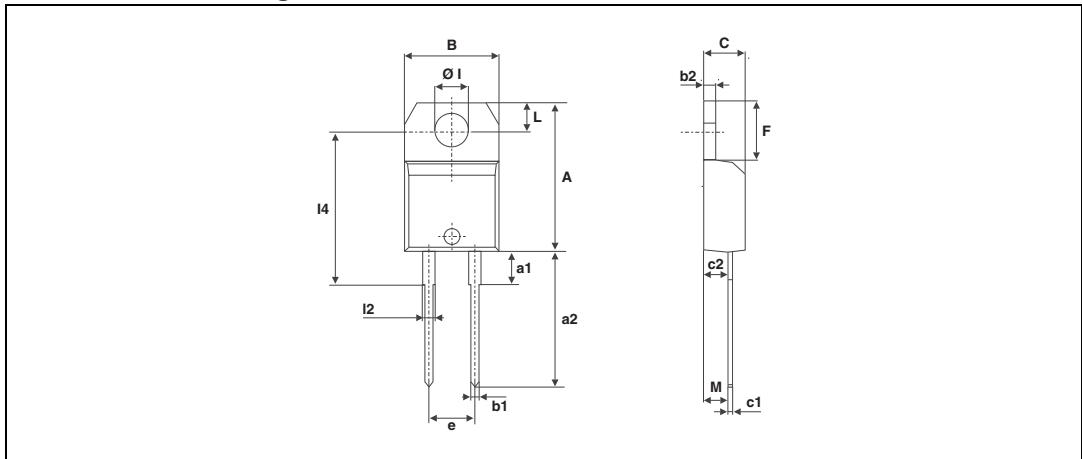

Table 6. T0-220AC ins dimension values

Ref.	Dimensions					
	Millimeters			Inches		
	Min.	Typ.	Max.	Min.	Typ.	Max.
A	15.20		15.90	0.598		0.625
a1		3.75			0.147	
a2	13.00		14.00	0.511		0.551
B	10.00		10.40	0.393		0.409
b1	0.61		0.88	0.024		0.034
b2	1.23		1.32	0.048		0.051
C	4.40		4.60	0.173		0.181
c1	0.49		0.70	0.019		0.027
c2	2.40		2.72	0.094		0.107
e	4.80		5.40	0.189		0.212
F	6.20		6.60	0.244		0.259
ØI	3.75		3.85	0.147		0.151
l4	15.80	16.40	16.80	0.622	0.646	0.661
L	2.65		2.95	0.104		0.116
l2	1.14		1.70	0.044		0.066
M		2.60			0.102	

3 Ordering information

Table 7. Ordering information

Order code	Marking	Package	Weight	Base qty	Delivery mode
STTH8T06DI	STTH8T06DI	TO-220AC ins	2.30 g	50	Tube

4 Revision history

Table 8. Document revision history

Date	Revision	Changes
16-Oct-2012	1	Initial release
07-Nov-2012	2	Expanded description section
11-Apr-2013	3	Added Figure 10 and Figure 11 .

Please Read Carefully:

Information in this document is provided solely in connection with ST products. STMicroelectronics NV and its subsidiaries ("ST") reserve the right to make changes, corrections, modifications or improvements, to this document, and the products and services described herein at any time, without notice.

All ST products are sold pursuant to ST's terms and conditions of sale.

Purchasers are solely responsible for the choice, selection and use of the ST products and services described herein, and ST assumes no liability whatsoever relating to the choice, selection or use of the ST products and services described herein.

No license, express or implied, by estoppel or otherwise, to any intellectual property rights is granted under this document. If any part of this document refers to any third party products or services it shall not be deemed a license grant by ST for the use of such third party products or services, or any intellectual property contained therein or considered as a warranty covering the use in any manner whatsoever of such third party products or services or any intellectual property contained therein.

UNLESS OTHERWISE SET FORTH IN ST'S TERMS AND CONDITIONS OF SALE ST DISCLAIMS ANY EXPRESS OR IMPLIED WARRANTY WITH RESPECT TO THE USE AND/OR SALE OF ST PRODUCTS INCLUDING WITHOUT LIMITATION IMPLIED WARRANTIES OF MERCHANTABILITY, FITNESS FOR A PARTICULAR PURPOSE (AND THEIR EQUIVALENTS UNDER THE LAWS OF ANY JURISDICTION), OR INFRINGEMENT OF ANY PATENT, COPYRIGHT OR OTHER INTELLECTUAL PROPERTY RIGHT.

ST PRODUCTS ARE NOT AUTHORIZED FOR USE IN WEAPONS. NOR ARE ST PRODUCTS DESIGNED OR AUTHORIZED FOR USE IN: (A) SAFETY CRITICAL APPLICATIONS SUCH AS LIFE SUPPORTING, ACTIVE IMPLANTED DEVICES OR SYSTEMS WITH PRODUCT FUNCTIONAL SAFETY REQUIREMENTS; (B) AERONAUTIC APPLICATIONS; (C) AUTOMOTIVE APPLICATIONS OR ENVIRONMENTS, AND/OR (D) AEROSPACE APPLICATIONS OR ENVIRONMENTS. WHERE ST PRODUCTS ARE NOT DESIGNED FOR SUCH USE, THE PURCHASER SHALL USE PRODUCTS AT PURCHASER'S SOLE RISK, EVEN IF ST HAS BEEN INFORMED IN WRITING OF SUCH USAGE, UNLESS A PRODUCT IS EXPRESSLY DESIGNATED BY ST AS BEING INTENDED FOR "AUTOMOTIVE, AUTOMOTIVE SAFETY OR MEDICAL" INDUSTRY DOMAINS ACCORDING TO ST PRODUCT DESIGN SPECIFICATIONS. PRODUCTS FORMALLY ESCC, QML OR JAN QUALIFIED ARE DEEMED SUITABLE FOR USE IN AEROSPACE BY THE CORRESPONDING GOVERNMENTAL AGENCY.

Resale of ST products with provisions different from the statements and/or technical features set forth in this document shall immediately void any warranty granted by ST for the ST product or service described herein and shall not create or extend in any manner whatsoever, any liability of ST.

ST and the ST logo are trademarks or registered trademarks of ST in various countries.

Information in this document supersedes and replaces all information previously supplied.

The ST logo is a registered trademark of STMicroelectronics. All other names are the property of their respective owners.

© 2013 STMicroelectronics - All rights reserved

STMicroelectronics group of companies

Australia - Belgium - Brazil - Canada - China - Czech Republic - Finland - France - Germany - Hong Kong - India - Israel - Italy - Japan - Malaysia - Malta - Morocco - Philippines - Singapore - Spain - Sweden - Switzerland - United Kingdom - United States of America

www.st.com

