

Demonstration programmer board based on the STPM01

Data Brief

Features

- Full compatible with the STPM01 energy meter and with the appropriate manager software
- Integrated system designed to provide a complete, ready-to-use energy meter
- High-end solution for power metering based on the STR710 Microcontroller with embedded RTC
- External memory interface (EMI) ready to drive 1 Mbyte of on-board SRAM.
- On-board optical insulated serial line
- On-board charge pump
- Access to the STPM01 device registers, using a dedicated SPI bus interface

Applications

- Demonstration purposes:
 - connecting the demonstration board to an AC power source and changing all the settings parameters through the GUI interface and the hardware programmer/reader board
- To evaluate and develop a custom application

Description

The STEVAL-IPE005V1 demonstration board works in conjunction with the STPM01 energy meter ASSP device and with the STPM01 manager software. It is an integrated system designed to provide the user with a complete, ready-to-use energy meter application. This board is a high-end solution for power metering based on the STR710 microcontroller with an embedded RTC and an external memory interface (EMI) ready to drive 1Mbyte of on-board SRAM. The demonstration board also integrates an on-board optical insulated serial line allowing isolation of the board ground reference in order to avoid propagation of over-voltage on the PC side.



Moreover, the on-board charge pump allows burning the STPM01 energy meter ASSP device registers.

Access to the STPM01 device registers is ensured using a dedicated SPI bus interface. The STPM01 programmer kit demonstrates how effectively the STPM01 can be used in real-world energy meter applications and it helps the user to develop his own application.

1 Demonstration board schematics

1.1 Microcontroller and main parts schematic

Figure 1. Microcontroller and main parts schematic

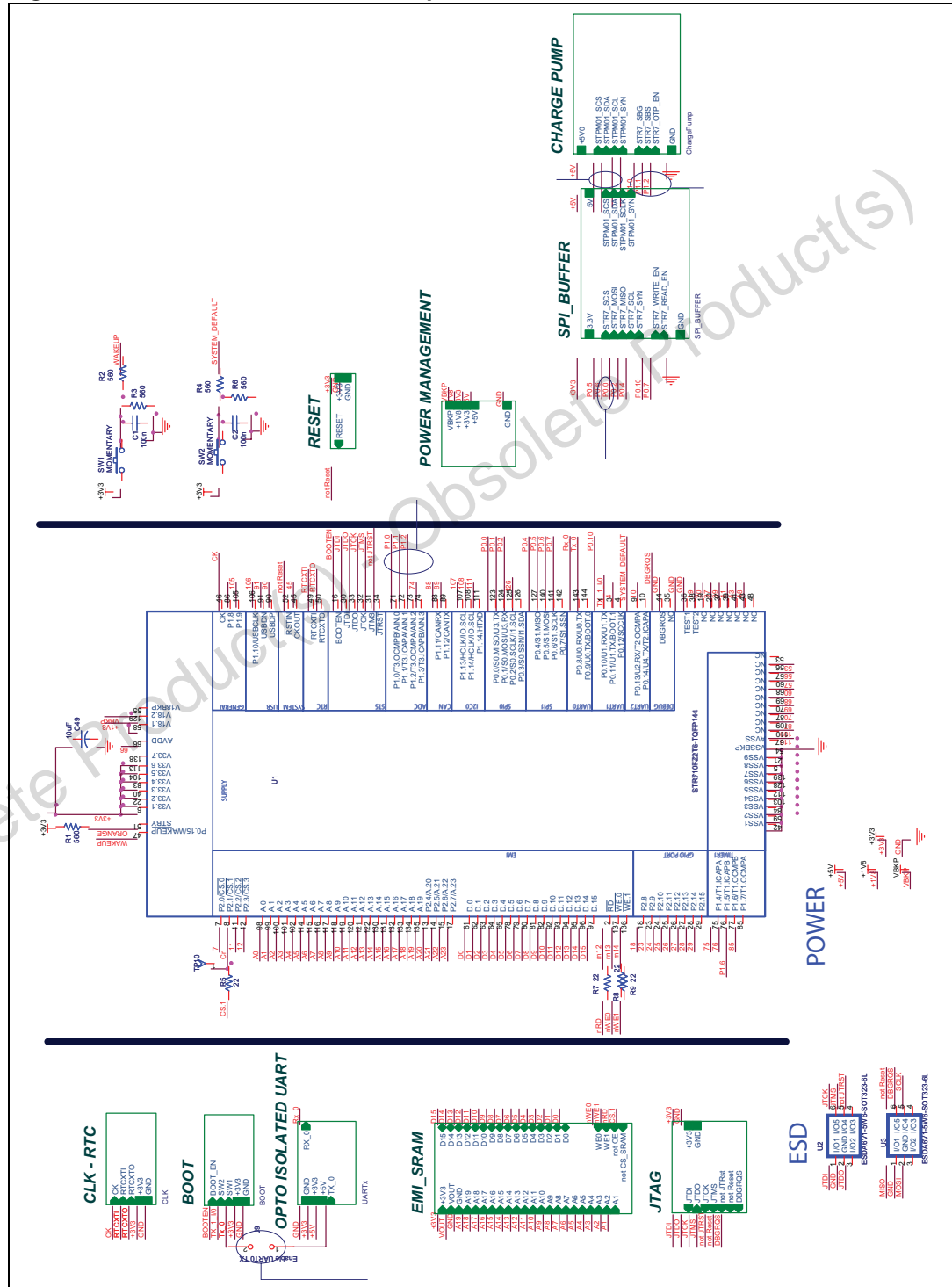

1.2 Power management

Figure 2. Power management schematic

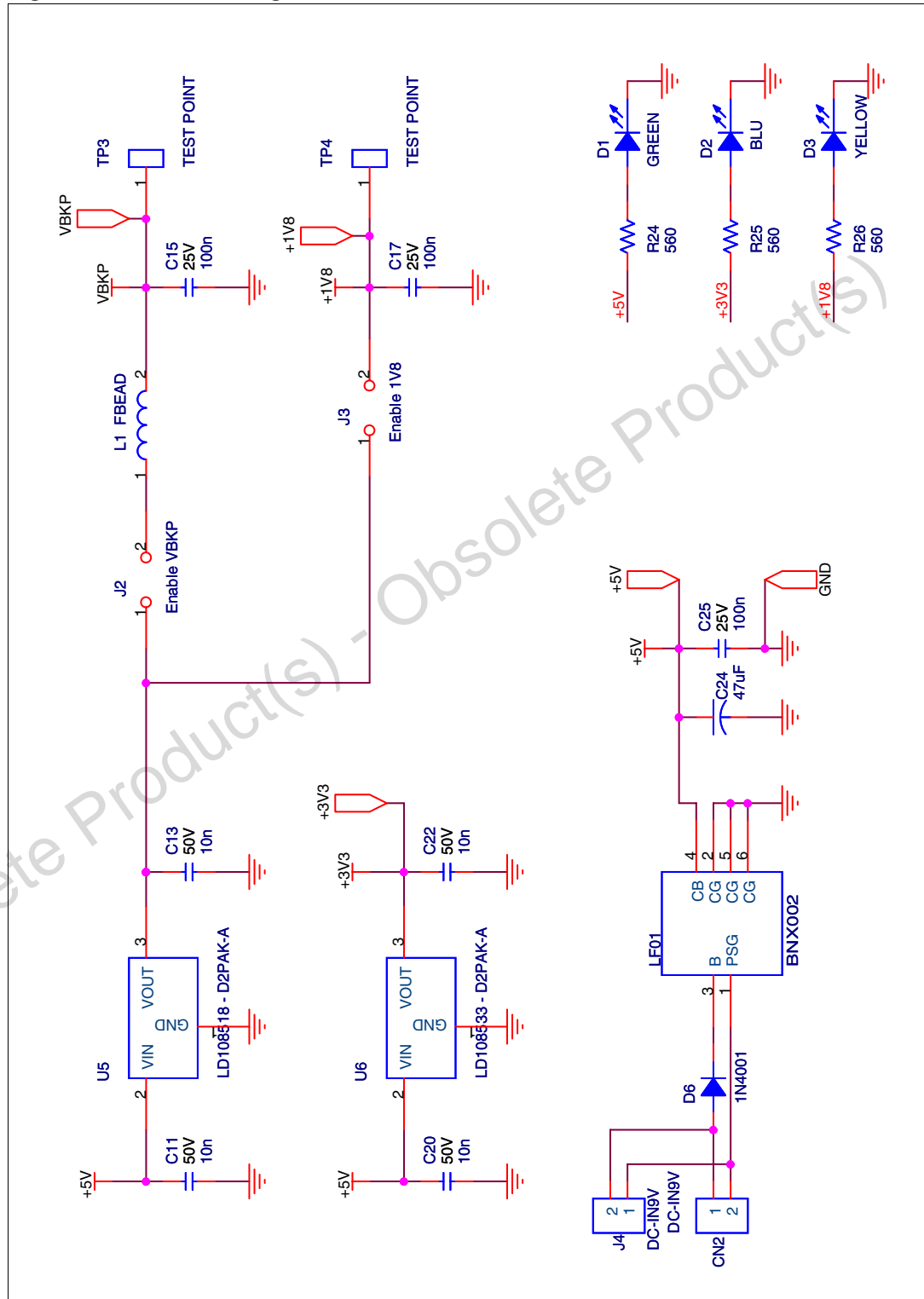

1.3 Reset and clock circuits

Figure 3. Reset and clock circuits

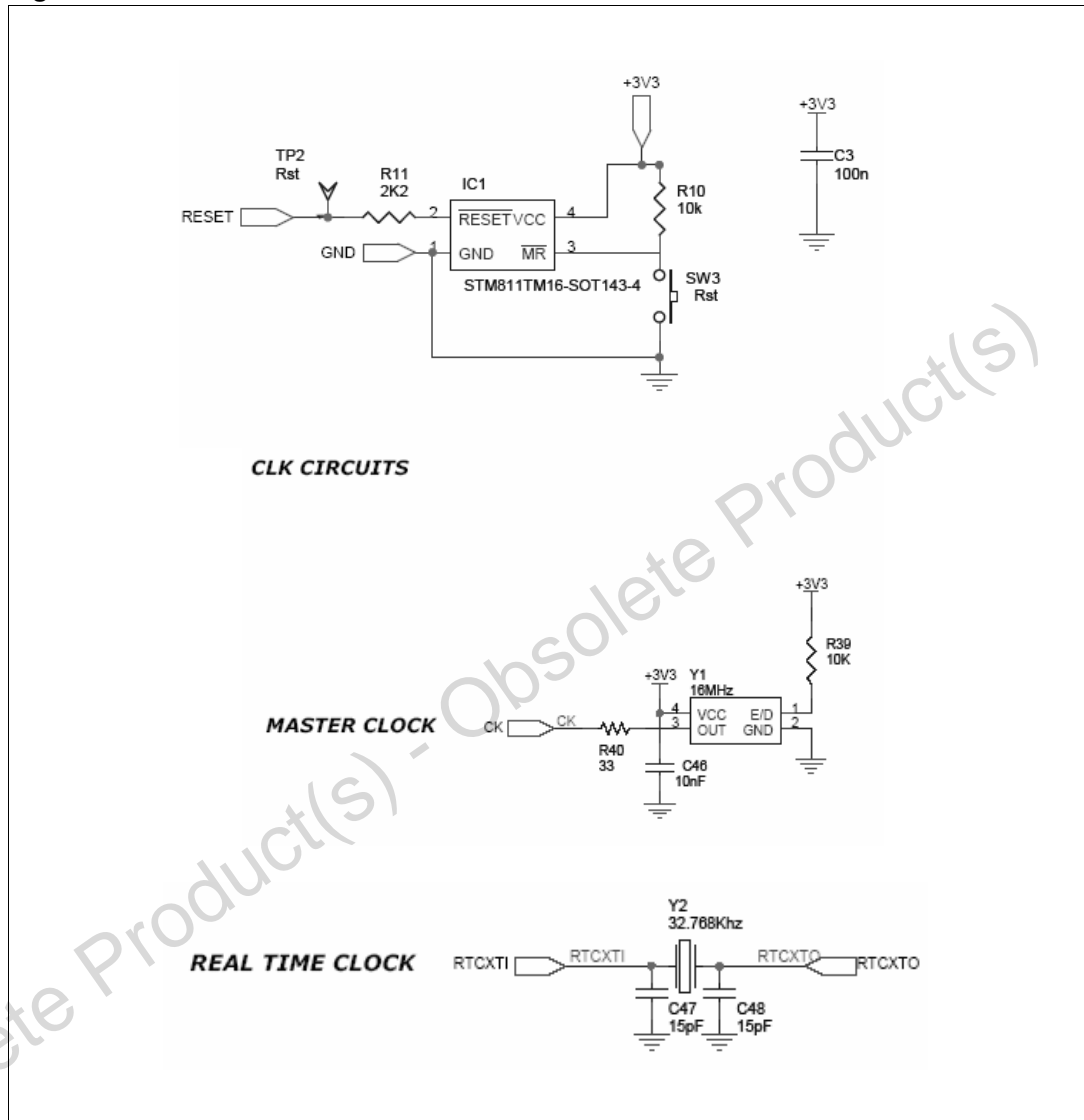

1.4 Boot management and Jtag circuit

Figure 4. Boot management and Jtag circuits

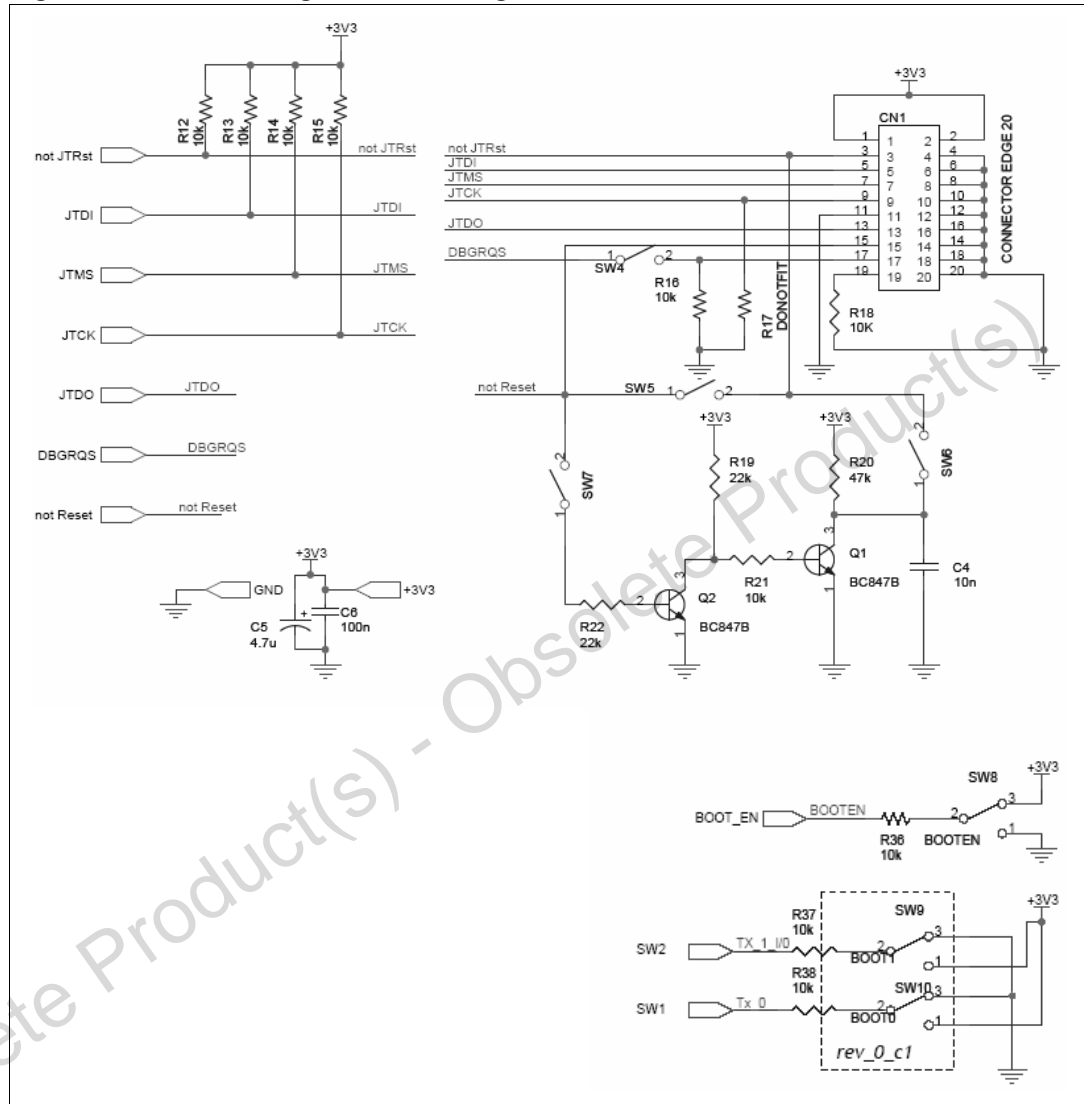
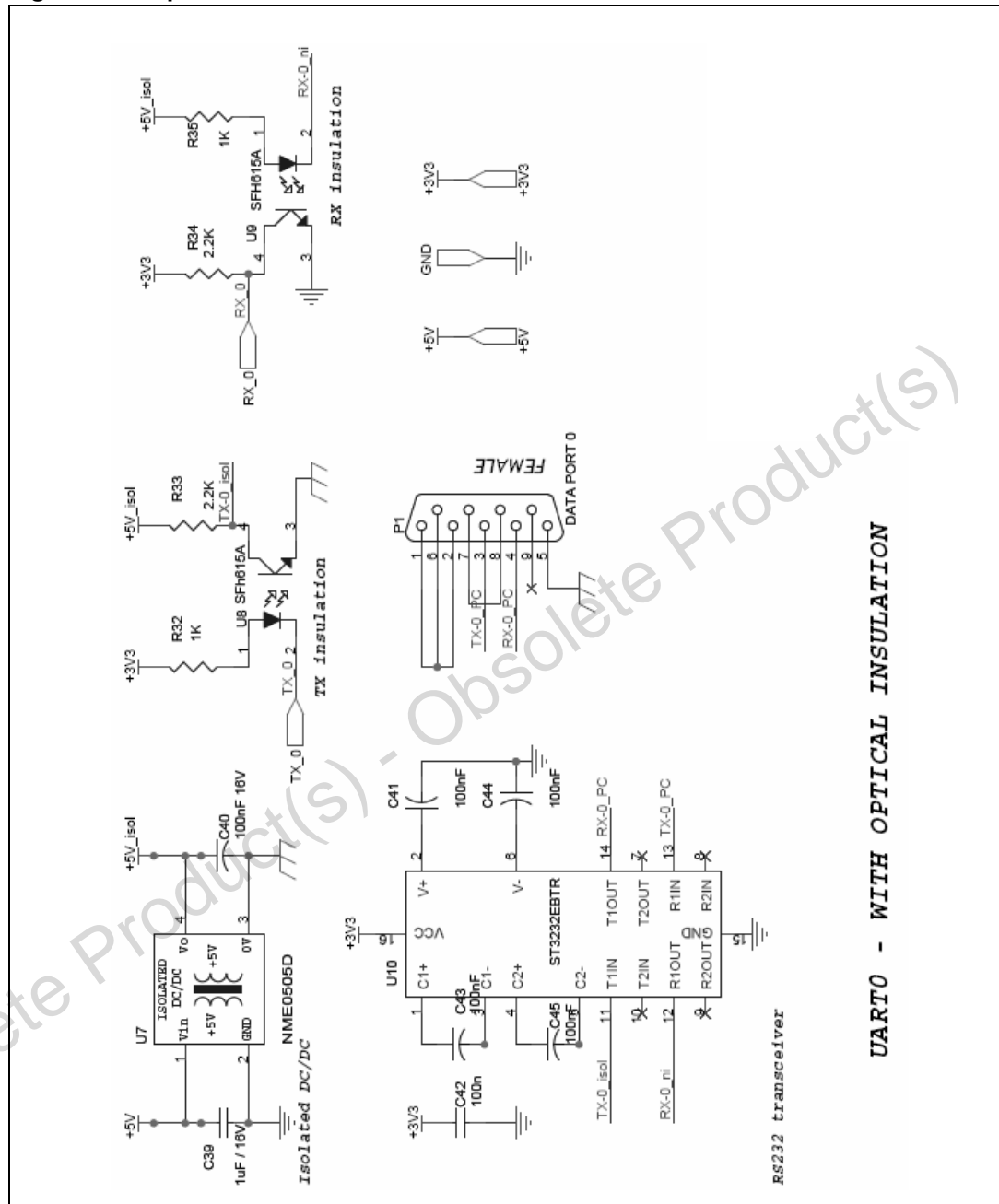
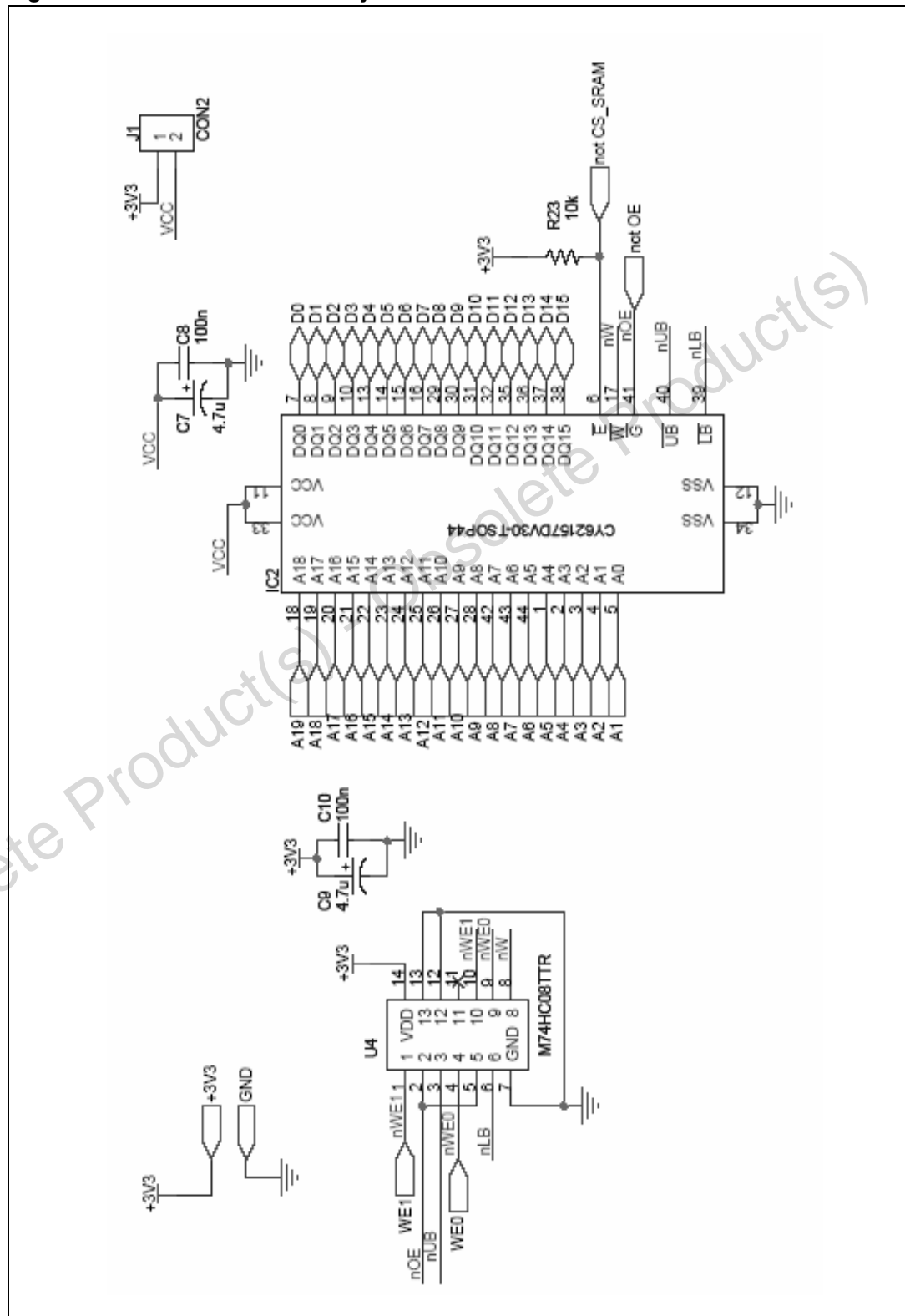

Figure 5. Opto-isolated UART



1.5 External RAM memory

Figure 6. External RAM memory



1.6 SPI signals buffering

Figure 7. SPI signals buffering

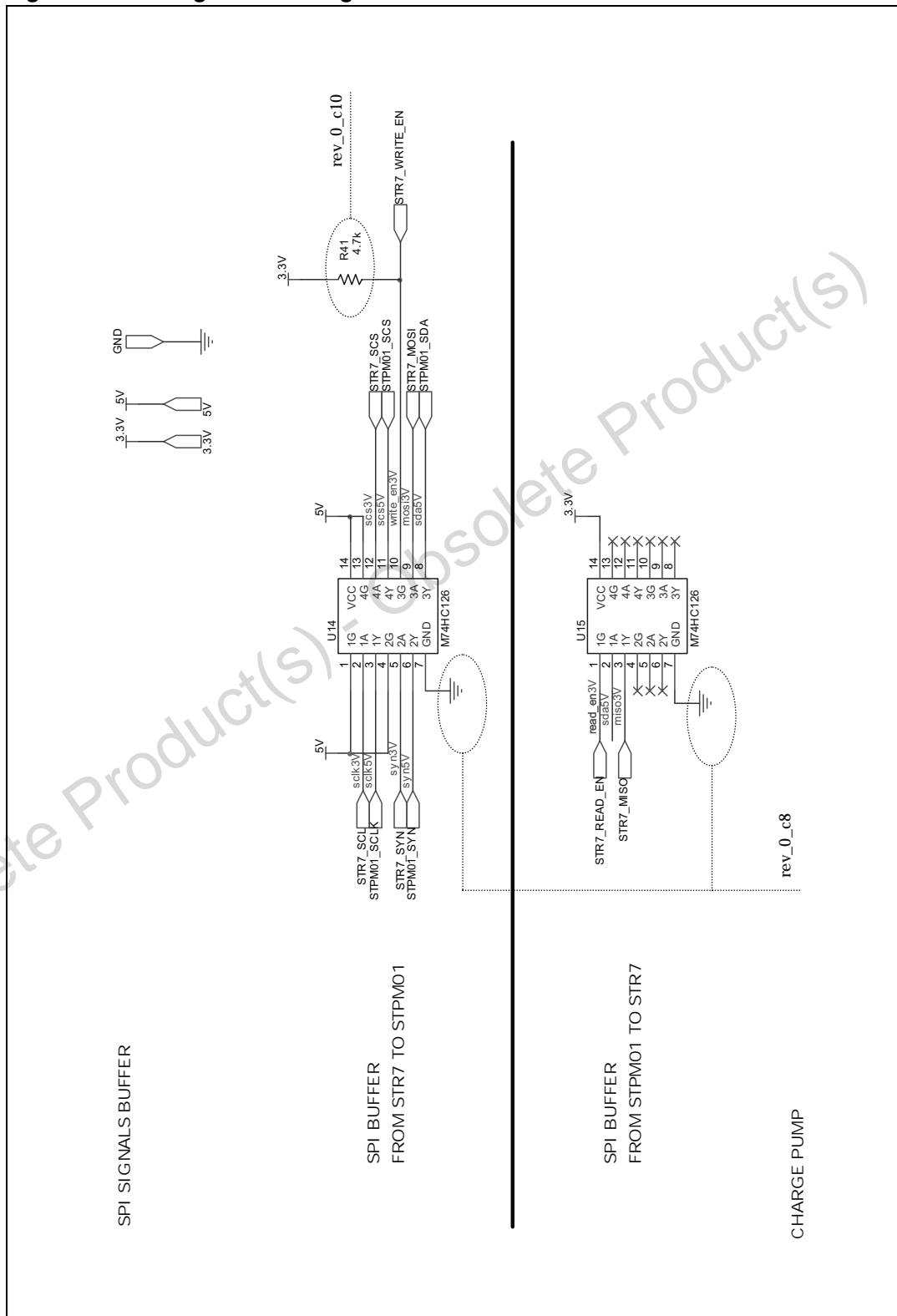

1.7 Charge pump and SPI connector

Figure 8. Charge pump and SPI connect

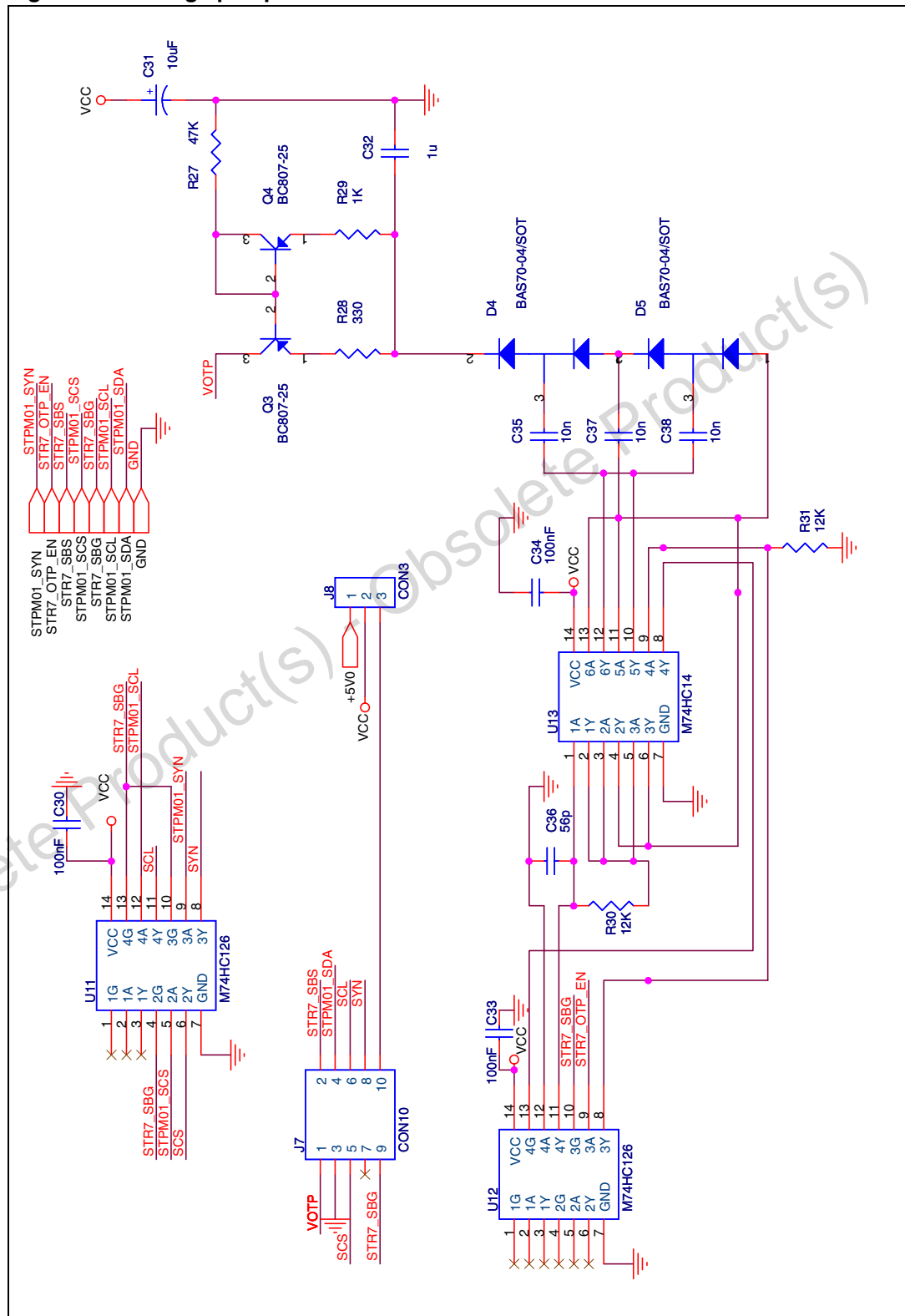

2 Revision history

Table 1. Document revision history

Date	Revision	Changes
24-Nov-2008	1	Initial release.

Obsolete Product(s) - Obsolete Product(s)

Please Read Carefully:

Information in this document is provided solely in connection with ST products. STMicroelectronics NV and its subsidiaries ("ST") reserve the right to make changes, corrections, modifications or improvements, to this document, and the products and services described herein at any time, without notice.

All ST products are sold pursuant to ST's terms and conditions of sale.

Purchasers are solely responsible for the choice, selection and use of the ST products and services described herein, and ST assumes no liability whatsoever relating to the choice, selection or use of the ST products and services described herein.

No license, express or implied, by estoppel or otherwise, to any intellectual property rights is granted under this document. If any part of this document refers to any third party products or services it shall not be deemed a license grant by ST for the use of such third party products or services, or any intellectual property contained therein or considered as a warranty covering the use in any manner whatsoever of such third party products or services or any intellectual property contained therein.

UNLESS OTHERWISE SET FORTH IN ST'S TERMS AND CONDITIONS OF SALE ST DISCLAIMS ANY EXPRESS OR IMPLIED WARRANTY WITH RESPECT TO THE USE AND/OR SALE OF ST PRODUCTS INCLUDING WITHOUT LIMITATION IMPLIED WARRANTIES OF MERCHANTABILITY, FITNESS FOR A PARTICULAR PURPOSE (AND THEIR EQUIVALENTS UNDER THE LAWS OF ANY JURISDICTION), OR INFRINGEMENT OF ANY PATENT, COPYRIGHT OR OTHER INTELLECTUAL PROPERTY RIGHT.

UNLESS EXPRESSLY APPROVED IN WRITING BY AN AUTHORIZED ST REPRESENTATIVE, ST PRODUCTS ARE NOT RECOMMENDED, AUTHORIZED OR WARRANTED FOR USE IN MILITARY, AIR CRAFT, SPACE, LIFE SAVING, OR LIFE SUSTAINING APPLICATIONS, NOR IN PRODUCTS OR SYSTEMS WHERE FAILURE OR MALFUNCTION MAY RESULT IN PERSONAL INJURY, DEATH, OR SEVERE PROPERTY OR ENVIRONMENTAL DAMAGE. ST PRODUCTS WHICH ARE NOT SPECIFIED AS "AUTOMOTIVE GRADE" MAY ONLY BE USED IN AUTOMOTIVE APPLICATIONS AT USER'S OWN RISK.

Resale of ST products with provisions different from the statements and/or technical features set forth in this document shall immediately void any warranty granted by ST for the ST product or service described herein and shall not create or extend in any manner whatsoever, any liability of ST.

ST and the ST logo are trademarks or registered trademarks of ST in various countries.

Information in this document supersedes and replaces all information previously supplied.

The ST logo is a registered trademark of STMicroelectronics. All other names are the property of their respective owners.

© 2008 STMicroelectronics - All rights reserved

STMicroelectronics group of companies

Australia - Belgium - Brazil - Canada - China - Czech Republic - Finland - France - Germany - Hong Kong - India - Israel - Italy - Japan - Malaysia - Malta - Morocco - Singapore - Spain - Sweden - Switzerland - United Kingdom - United States of America

www.st.com