

LDO with Reverse Current Protection / Soft Start / Discharge Function

■ GENERAL DESCRIPTION

The NJM12884 is a low dropout regulator which achieves high ripple rejection, low noise and high speed response with the bipolar technology.

Adjustable soft-start function is useful for reducing inrush current and controlling power-on sequence. Moreover the discharge function makes effective sequence control with the soft-start function.

In addition, the reverse current protection makes external SBD unnecessary.

■ PACKAGE OUTLINE

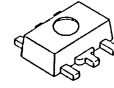

NJM12884U2

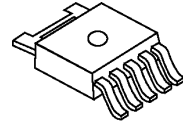

NJM12884DL3

■ FEATURE

- Operating Voltage Range 2.3V to 6.5V
- Output Voltage Accuracy $V_O \pm 1.0\%$
- Output Current $I_O(\text{min.})=500\text{mA}$
- Reverse Current Protection
- Adjustable soft-start Function
- Discharge Function
- ON/OFF Control
- Correspond to Low ESR capacitor (MLCC)
- Thermal Shutdown Circuit
- Over Current Protection Circuit
- Package Outline SOT-89-5, TO-252-5

■ PIN CONFIGURATION

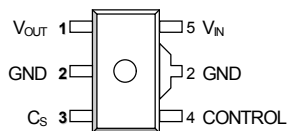

NJM12884U2

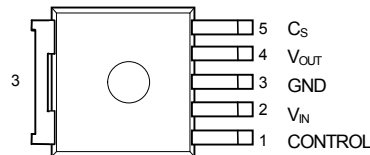

NJM12884DL3

■ BLOCK DIAGRAM

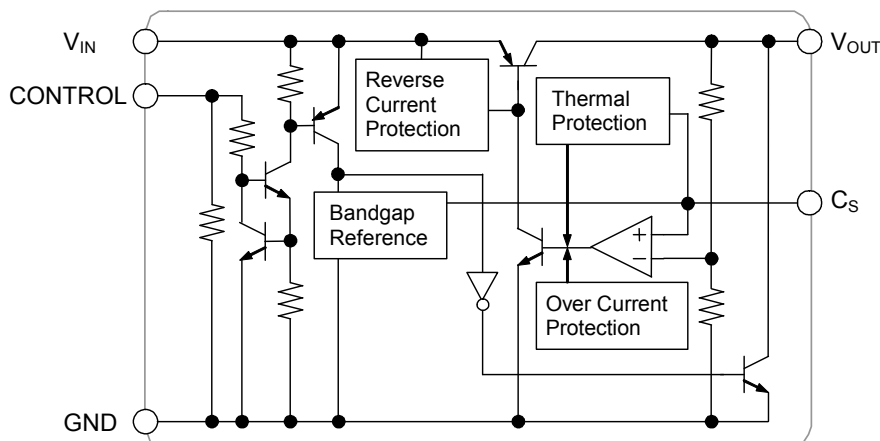

NJM12884

■ OUTPUT VOLTAGE RANK LIST

SOT-89-5

TO-252-5

Device Name	Output Voltage	Device Name	Output Voltage
NJM12884U2-15	1.5V	NJM12884DL3-15	1.5V
NJM12884U2-18	1.8V	NJM12884DL3-18	1.8V
NJM12884U2-25	2.5V	NJM12884DL3-25	2.5V
NJM12884U2-33	3.3V	NJM12884DL3-33	3.3V
NJM12884U2-05	5.0V	NJM12884DL3-05	5.0V

■ ABSOLUTE MAXIMUM RATINGS

(Ta=25°C)

PARAMETER	SYMBOL	MAXIMUM RATING		UNIT
Input Voltage	V _{IN}	-0.3 ~ +7		V
Control Pin Voltage	V _{CONT}	-0.3 ~ +7		V
Output Voltage	V _{OUT}	V _o ≤ 1.8V	-0.3 ~ +5.5	V
		V _o > 1.8V	-0.3 ~ +7	V
Soft start Pin Voltage	V _{CS}	-0.3 ~ +4		V
Power Dissipation	P _D	SOT-89-5	625(*1)	mW
			2400(*2)	
		TO-252-5	1190(*1)	
			3125(*2)	
Junction Temperature Range	T _J	-40 ~ +150		°C
Operating Temperature Range	T _{opr}	-40 ~ +125		°C
Storage Temperature Range	T _{stg}	-50 ~ +150		°C

(*1): Mounted on glass epoxy board. (76.2 × 114.3 × 1.6mm:based on EIA/JDEC standard size, 2Layers, Cu area 100mm²)

(*2): Mounted on glass epoxy board. (76.2 × 114.3 × 1.6mm:based on EIA/JDEC standard, 4Layers)

(For 4Layers: Applying 74.2 × 74.2mm inner Cu area and a thermal via hole to a board based on JEDEC standard JESD51-5)

■ Operating Voltage Range : V_{IN}=2.3V~6.5V

■ ELECTRICAL CHARACTERISTICS

(Unless other noted,

$V_{IN} = V_O + 1V$, $C_{IN} = 0.33\mu F$, $C_O = 0.33\mu F$ ($C_O = 0.47\mu F : 2.9V < V_O \leq 3.4V$, $C_O = 2.2\mu F : 1.7V < V_O \leq 2.9V$, $C_O = 4.7\mu F : V_O \leq 1.7V$), $C_S = 0.01\mu F$, $T_a = 25^\circ C$)

PARAMETER	SYMBOL	TEST CONDITION	MIN.	TYP.	MAX.	UNIT	
Output Voltage	V_O	$I_O = 100mA$	-1.0%	-	+1.0%	V	
Quiescent Current	I_Q	$I_O = 0mA$, except I_{CONT}	-	200	280	μA	
Quiescent Current at OFF-state	$I_{Q(OFF)}$	$V_{CONT} = 0V$	-	-	10	μA	
Output Current	I_O	$V_O \times 0.9$	500	-	-	mA	
Line Regulation	$\Delta V_O / \Delta V_{IN}$	$V_{IN} = V_O + 1V \sim 6.5V$, $I_O = 100mA$	-	-	0.1	%/V	
Load Regulation	$\Delta V_O / \Delta I_O$	$I_O = 0 \sim 500mA$	-	-	0.005	%/mA	
Dropout Voltage (*3)	ΔV_{IO}	$I_O = 300mA$	-	0.18	0.25	V	
Average Temperature Coefficient of Output Voltage	$\Delta V_O / \Delta T_a$	$T_a = -40 \sim +125^\circ C$, $I_O = 100mA$	-	± 50	-	ppm/ $^\circ C$	
Ripple Rejection	RR	$e_{in} = 200mV_{rms}$, $f = 1kHz$, $I_O = 10mA$	$V_O = 1.5V$	-	76	-	dB
			$V_O = 1.8V$	-	74	-	
			$V_O = 2.5V$	-	71	-	
			$V_O = 3.3V$	-	68	-	
			$V_O = 5.0V$	-	64	-	
Output Noise Voltage	V_{NO}	$f = 10Hz \sim 80kHz$, $I_O = 10mA$	$V_O = 1.5V$	-	15	-	μV_{rms}
			$V_O = 1.8V$	-	19	-	
			$V_O = 2.5V$	-	24	-	
			$V_O = 3.3V$	-	28	-	
			$V_O = 5.0V$	-	40	-	
Control Current	I_{CONT}	$V_{CONT} = 1.6V$	-	3	12	μA	
Control Voltage at ON-state	$V_{CONT(ON)}$		1.6	-	-	V	
Control Voltage at OFF-state	$V_{CONT(OFF)}$		-	-	0.6	V	
Soft Start Time	$t_{S(ON)}$	$V_{CONT} = L \rightarrow H$, $I_O = 100mA$, $C_S = 0.022\mu F$	-	1.2	-	msec	
Discharge Current at OFF-state	I_{DIS}	$V_{IN} = 2.3V$, $V_{CONT} = 0V$, $V_O = 0.5V$	2	9	-	mA	
		$V_{IN} = 6.5V$, $V_{CONT} = 0V$, $V_O = 0.5V$	15	25	-		

(*3): Except Output Voltage Rank less than 2.1V

The above specification is a common specification for all output voltages.

Therefore, it may be different from the individual specification for a specific output voltage.

■ POWER DISSIPATION vs. AMBIENT TEMPERATURE

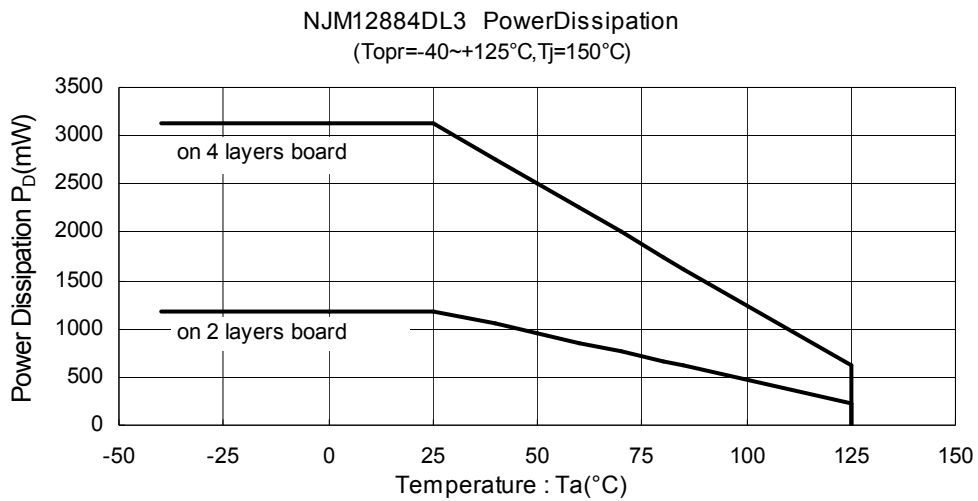
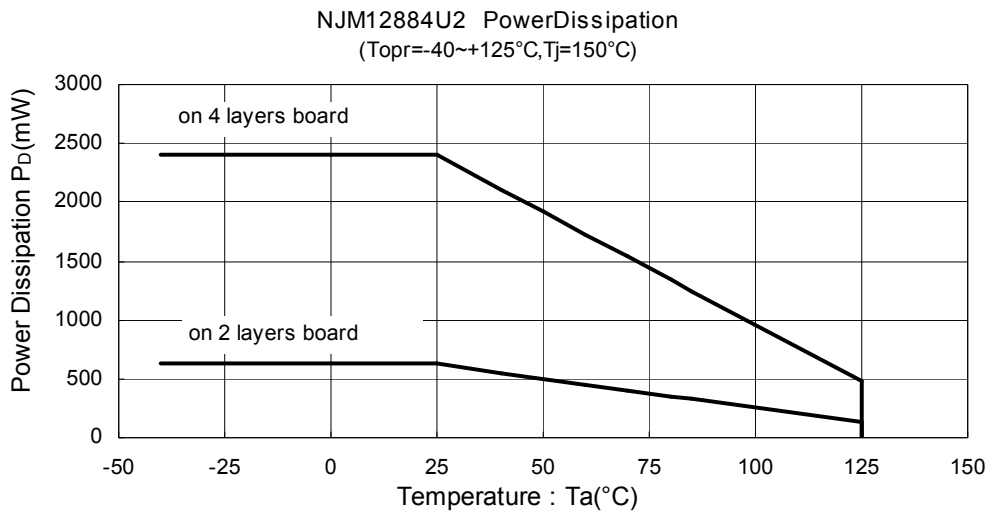

■ TEST CIRCUIT

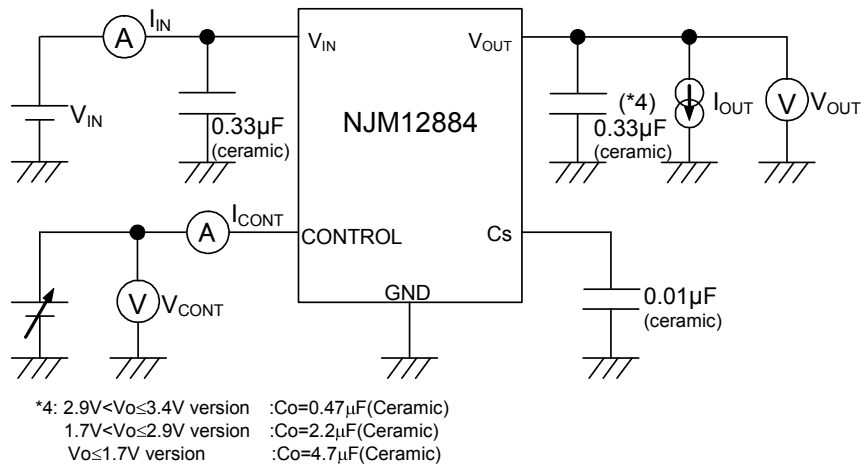

■ TYPICAL APPLICATION

1. In the case where ON/OFF Control is not required

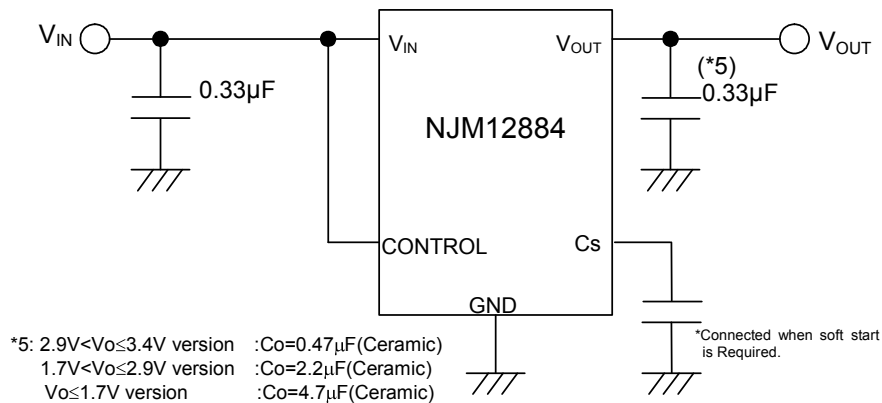

Connect CONTROL Pin to V_{IN} Pin

2. In use of ON/OFF CONTROL

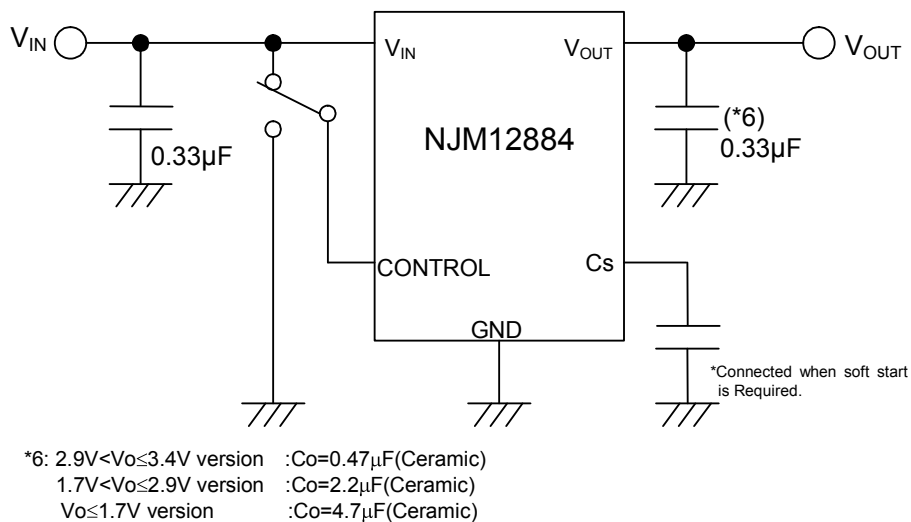

State of CONTROL Pin:

“H” → output is enabled.

“L” or “open” → output is disabled

NJM12884

*Reverse Current Protection

The NJM12884 has built-in Reverse Current Protection circuit.

This circuit prevents the large reverse current when output voltage is higher than input voltage.

Therefore external schottky-barrier diode(SBD) is not required

*Soft Start capacitor Cs

The Soft Start function can control the rise time of Output Voltage and reduce the inrush current by connecting the Cs capacitor.

The Soft Start time is defined as 10% to 90% of the Output Voltage.

The Cs capacitor is not essential, but it used for noise bypass of bandgap reference either. Therefore Output Noise Voltage increases when the capacitor isn't connected.

If the Cs capacitor is not used, the Cs Pin should be OPEN.

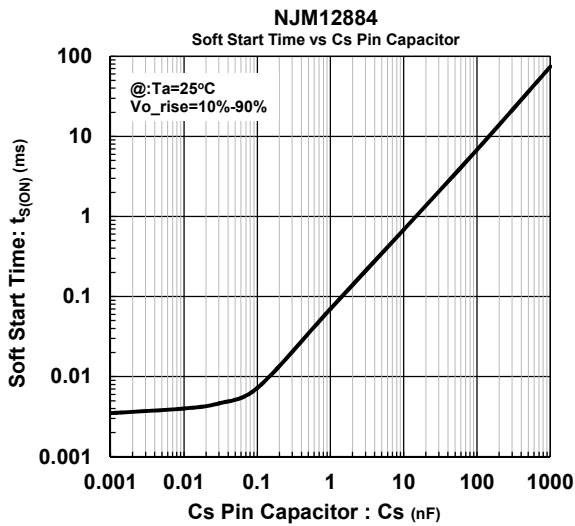

Soft-Start Time vs. Cs Pin Capacitor

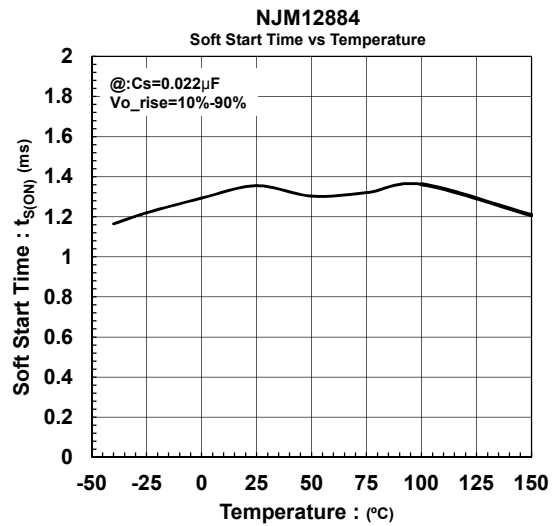

Soft-Start Time (0.022µF) vs. Temperature

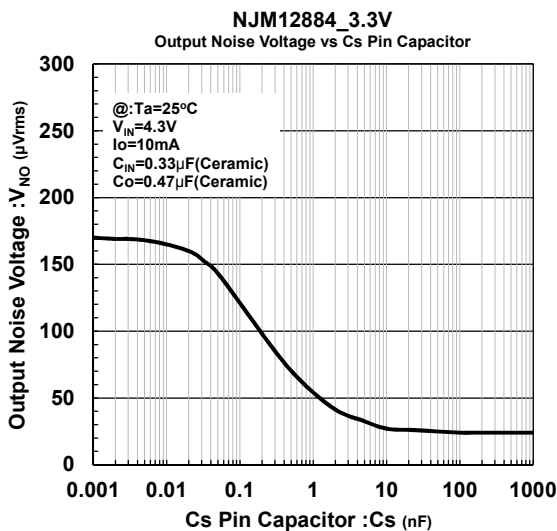

Output Noise Voltage vs. Cs Pin Capacitor

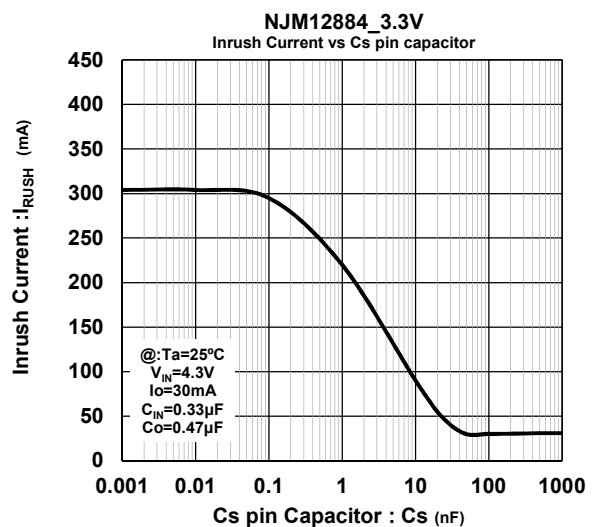

Inrush Current vs. Cs Pin Capacitor

***Discharge Function**

The NJM12884 has a built-in discharge circuit to discharge the charged output capacitors.

Discharge circuit operates when the CONTROL Pin is set in LOW level. The circuit discharges the charged output capacitors rapidly.

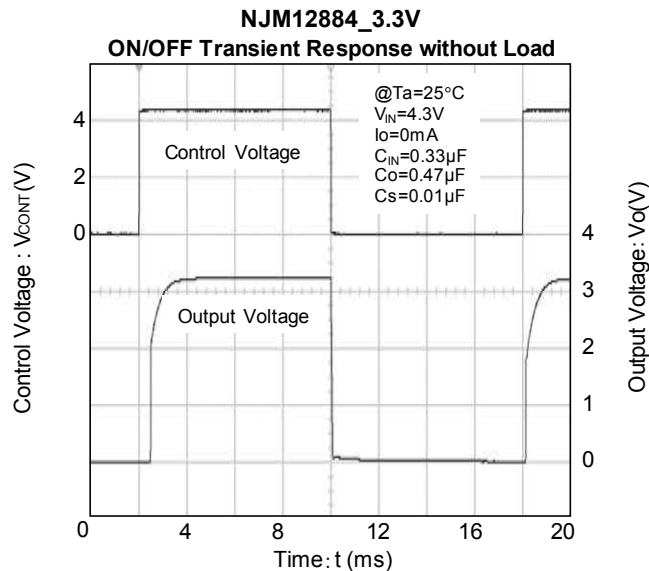

***Input Capacitor CIN**

The input capacitor CIN is required to prevent oscillation and reduce power supply ripple for applications when high power supply impedance or a long power supply line.

Therefore, use the recommended CIN value (refer to conditions of ELECTRIC CHARACTERISTIC) or larger and should connect between GND and VIN as shortest path as possible to avoid the problem.

***Output Capacitor CO**

The output capacitor CO will be required for a phase compensation of the internal error amplifier.

The capacitance and the equivalent series resistance (ESR) influence to stable operation of the regulator.

Use of a smaller CO may cause excess an output noise or an oscillation of the regulator due to lack of the phase compensation.

On the other hand, use of a larger CO reduces an output noise and a ripple output, and also improves an output transient response when a load rapidly changes.

Therefore, use the recommended CO value (refer to conditions of ELECTRIC CHARACTERISTIC) or larger and should connect between GND and VOUT as shortest path as possible for stable operation

The recommended capacitance depends on the output voltage rank. Especially, a low voltage regulator requires larger CO value.

In addition, you should consider varied characteristics of capacitor (a frequency characteristic, a temperature characteristic, a DC bias characteristic and so on) and unevenness peculiar to a capacitor supplier enough.

When selecting CO, recommend that have withstand voltage margin against an output voltage and superior temperature characteristics though this product is designed stability works with wide range ESR of capacitor including low ESR products.

TYPICAL CHARACTERISTICS

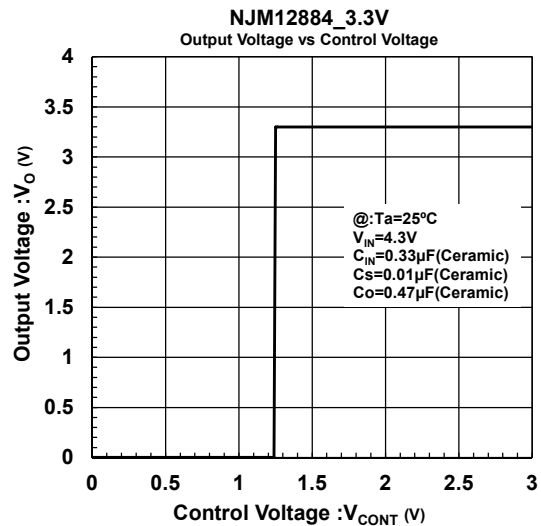
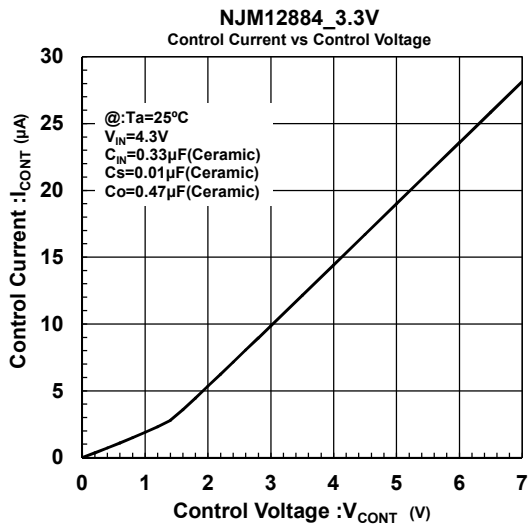
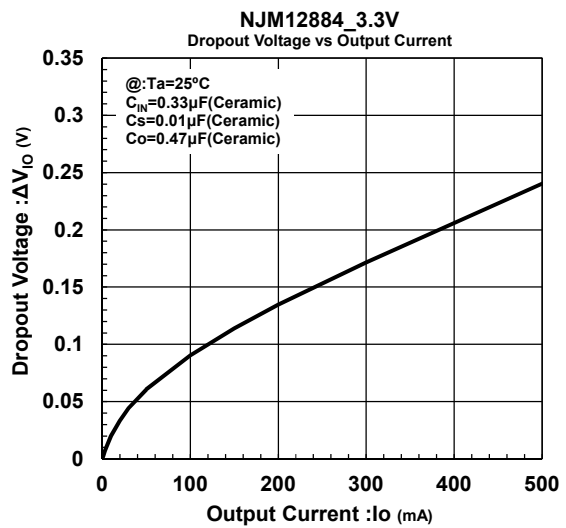
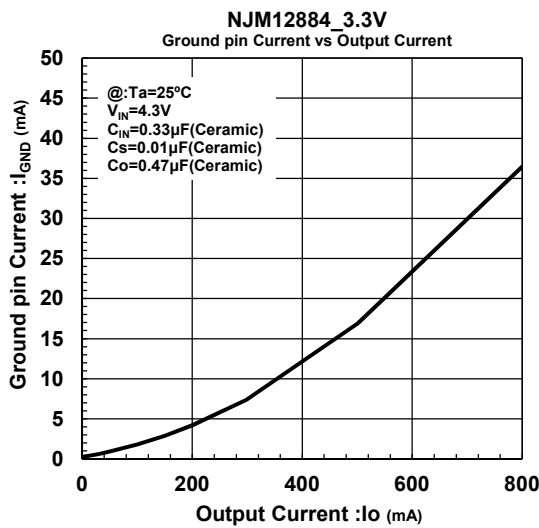
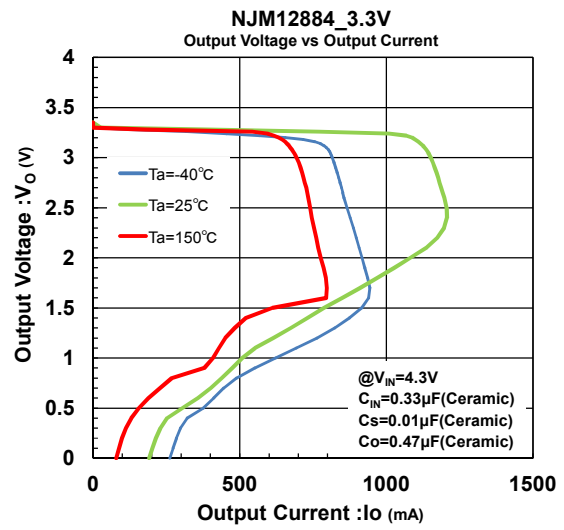
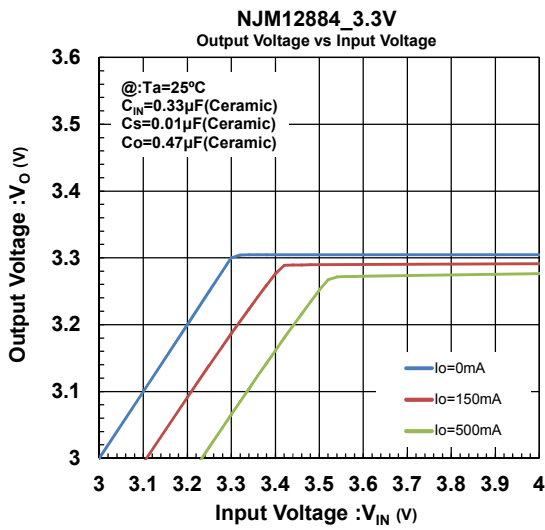

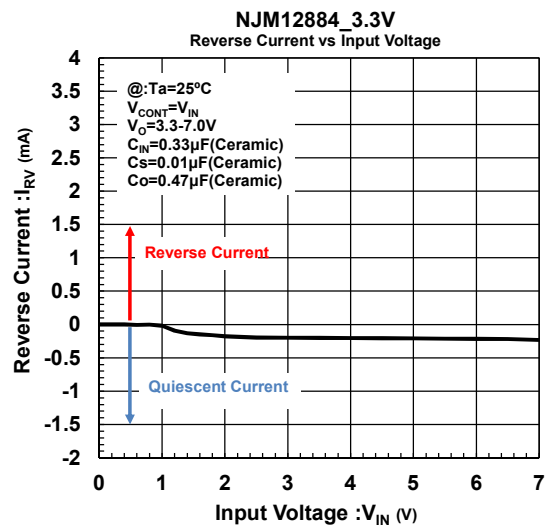
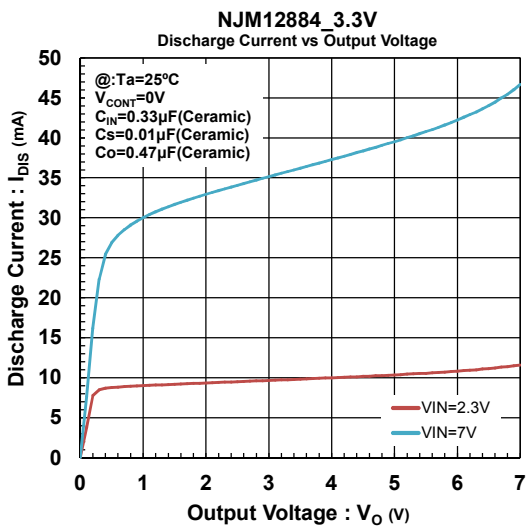
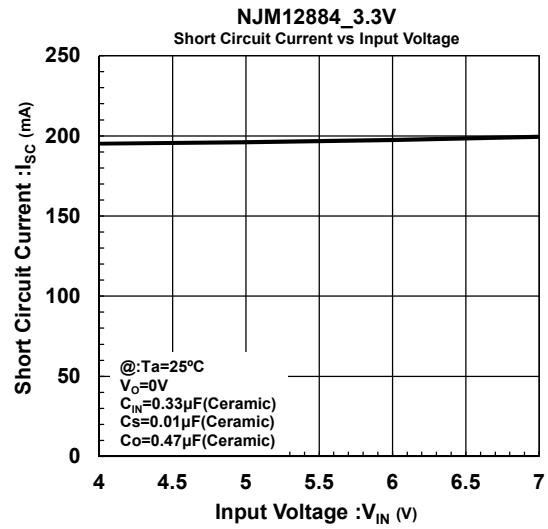
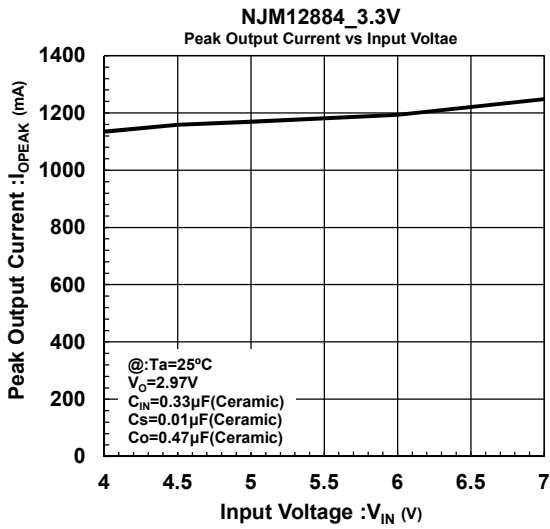
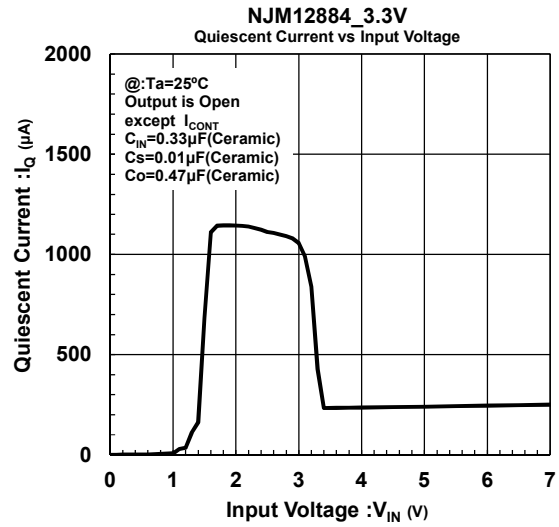
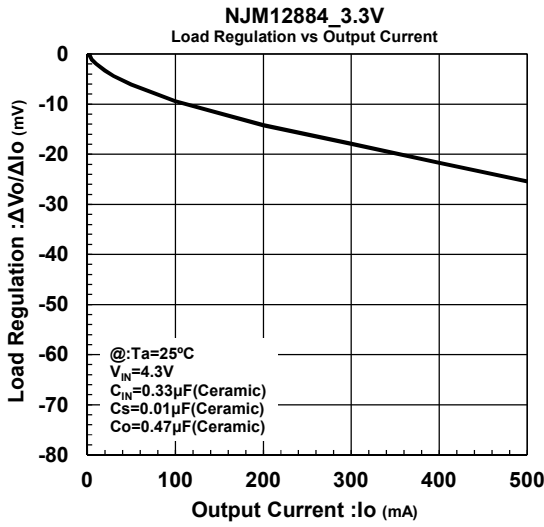

NJM12884

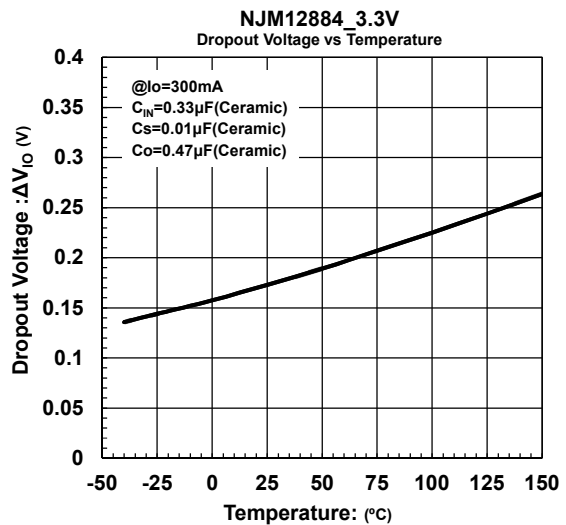
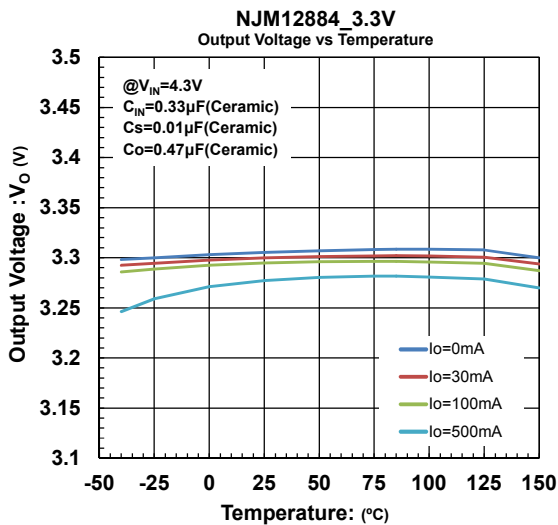
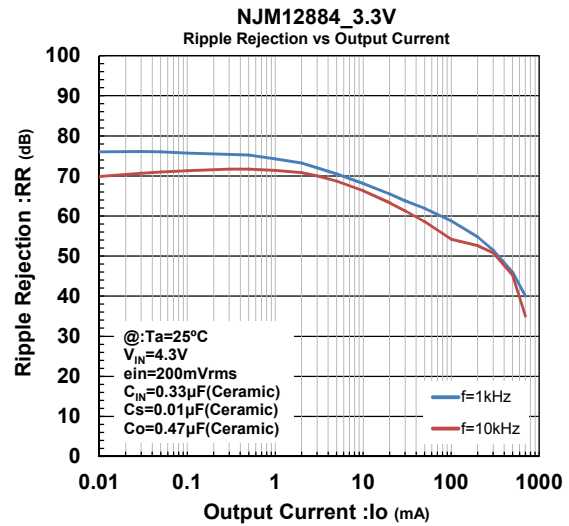
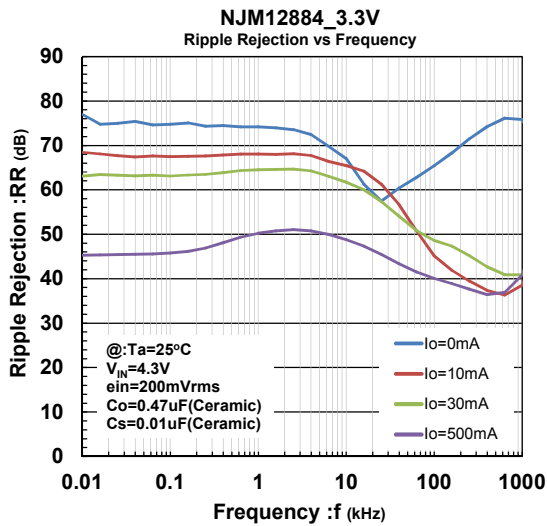
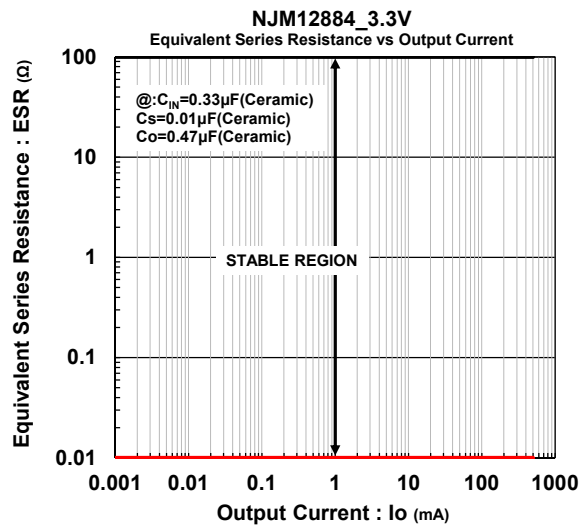
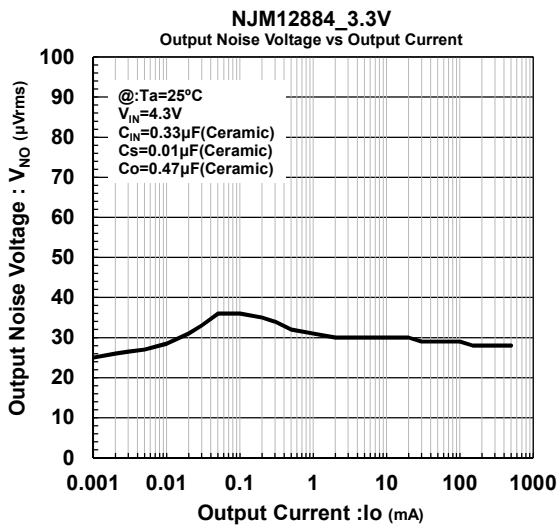

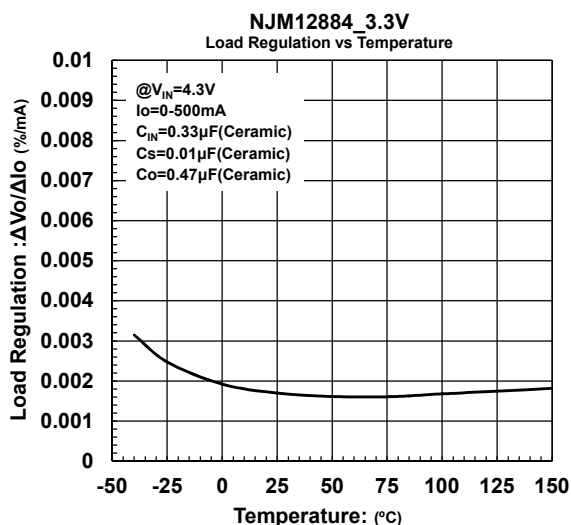
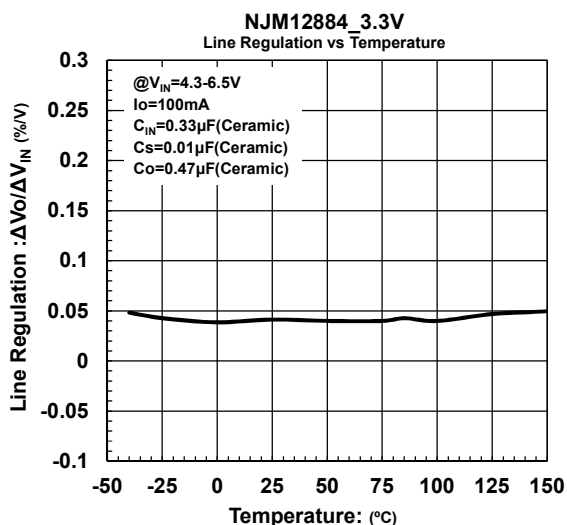
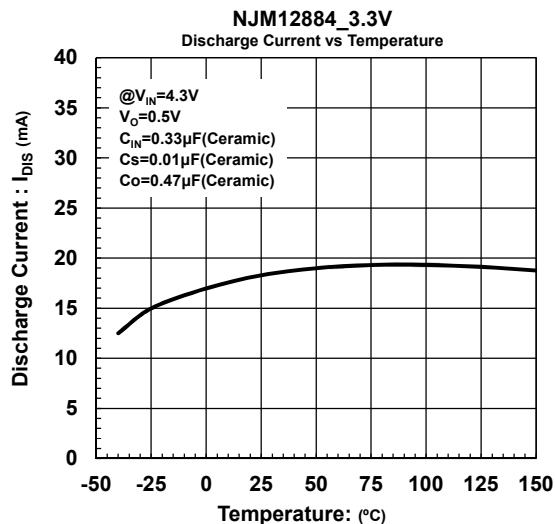
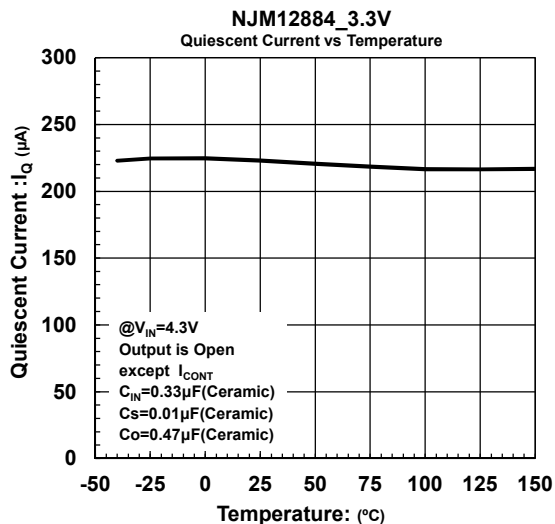
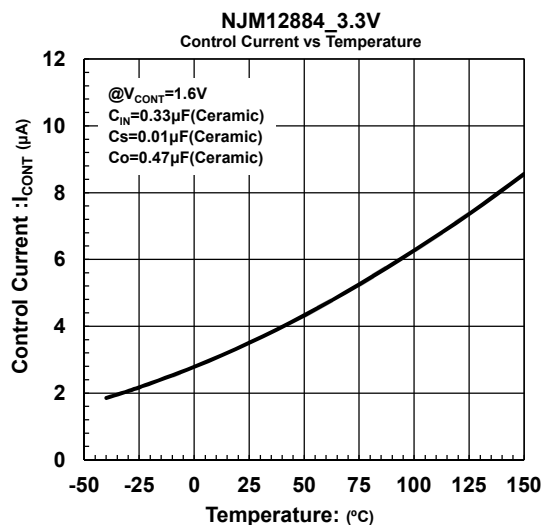
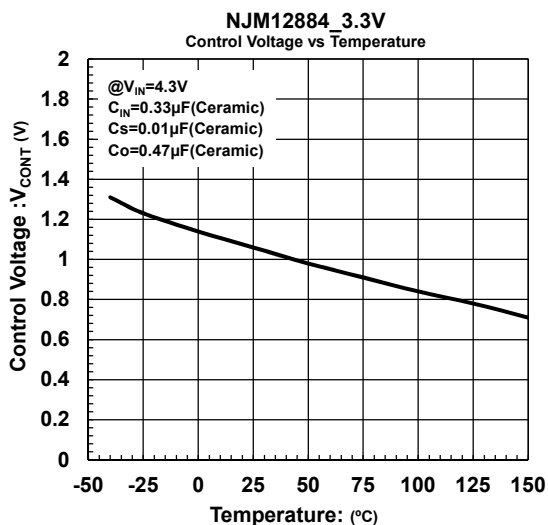

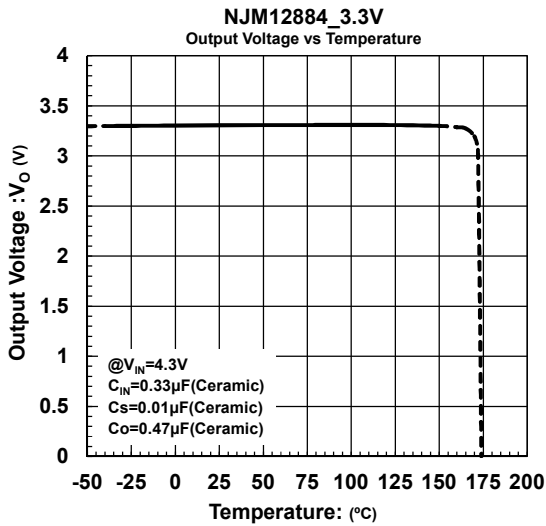
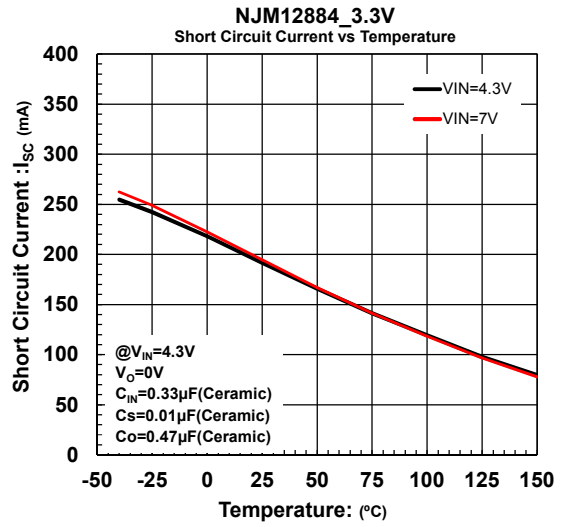
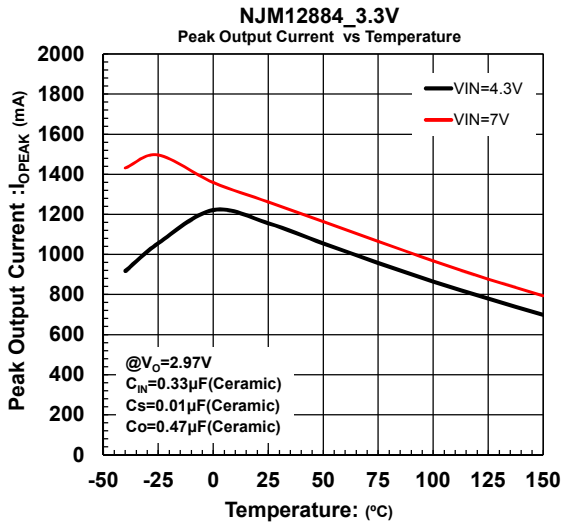

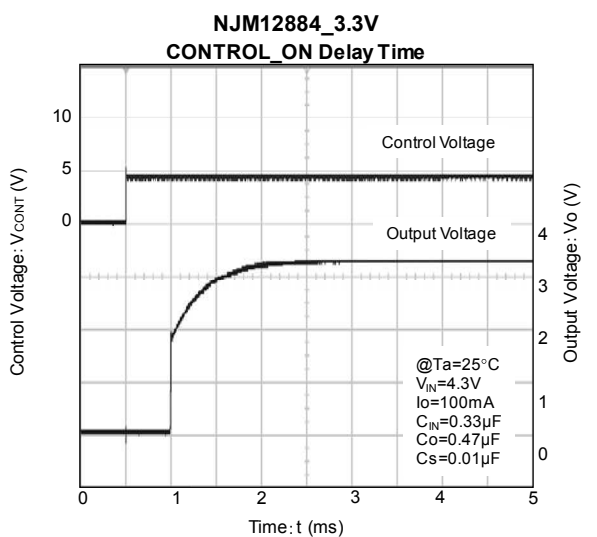
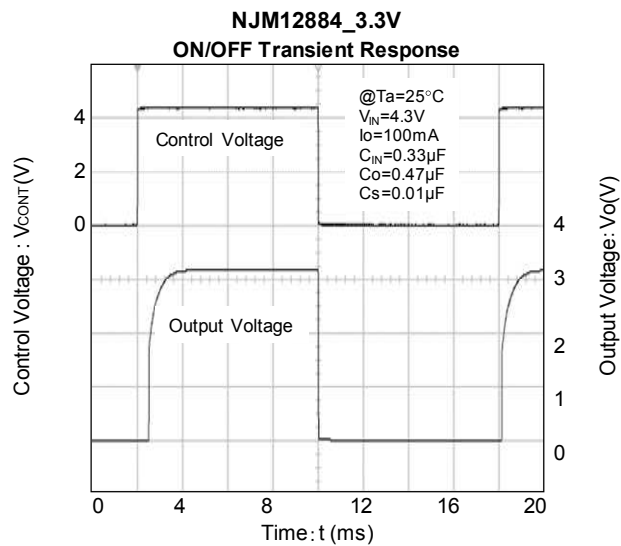
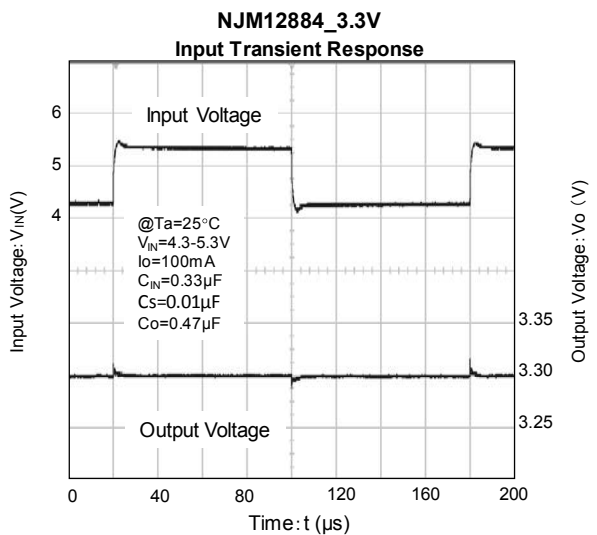
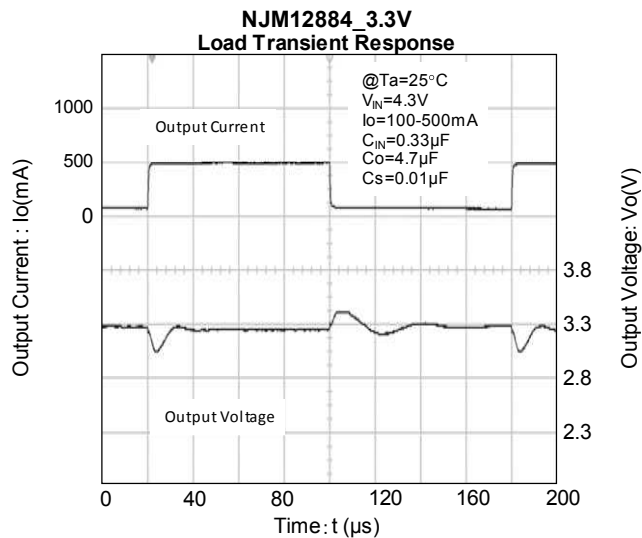
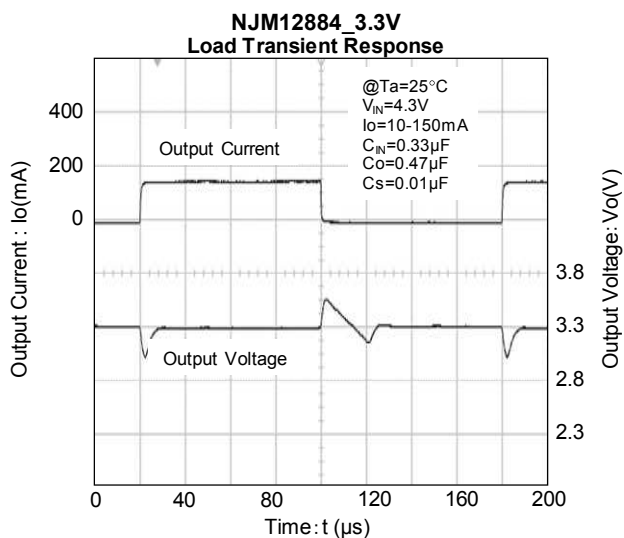

[CAUTION]

The specifications on this databook are only given for information, without any guarantee as regards either mistakes or omissions. The application circuits in this databook are described only to show representative usages of the product and not intended for the guarantee or permission of any right including the industrial rights.