

IoT OPTIMIZED LOW PROFILE QUARTZ CRYSTAL

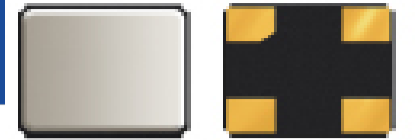

2.5 x 2.0 x 0.6mm

RoHS/RoHS II Compliant

MSL = N/A: NOT APPLICABLE

ABM10W SERIES

FEATURES

- Optimized for energy saving wearables and IoT applications
- Plated at exceptionally low plating capacitance, as low as 4pF, with optimized ESR
- 0.6 mm max height ideally suited for height constrained designs
- Seam sealed for longterm reliability

APPLICATIONS

- Wearables
- Internet of Things (IoT)
- Bluetooth/Bluetooth Low Energy (BLE)
- Wireless modules
- Machine-to-machine (M2M) connectivity
- Ultra-low power MCU
- Near Field Communication (NFC)
- ISM Band

STANDARD SPECIFICATIONS

| Parameters | Minimum | Typical | Maximum | Units | Notes |
|---|-------------|---------|---------|-------|----------------------|
| Frequency Range | 16.0000 | | 50.0000 | MHz | |
| Operation Mode | Fundamental | | | | |
| Operating Temperature Range | -40 | | +125 | °C | See options |
| Storage Temperature | -55 | | +125 | °C | |
| Frequency Tolerance @ +25°C | -10 | | +10 | ppm | See options |
| Frequency Stability over the Operating Temperature (ref. to +25°C) | -10 | | +10 | ppm | See options |
| Equivalent series resistance "R1" (over Operating Temperature Range) (CL=4pF) | | < 70 | 100 | Ω | 16.0000 – 19.9999MHz |
| | | < 50 | 80 | | 20.0000 – 29.9999MHz |
| | | < 40 | 60 | | 30.0000 – 39.9999MHz |
| | | < 25 | 40 | | 40.0000 – 50.0000MHz |
| Equivalent series resistance "R1" (over Operating Temperature Range) (CL=6pF, 7pF, 8pF) | | < 50 | 70 | Ω | 16.0000 – 19.9999MHz |
| | | < 35 | 50 | | 20.0000 – 29.9999MHz |
| | | < 30 | 40 | | 30.0000 – 39.9999MHz |
| | | < 25 | 30 | | 40.0000 – 50.0000MHz |
| Shunt capacitance (C0) | | < 1.0 | 2.0 | pF | |
| Load capacitance (CL) | | 4.0 | | pF | See options |
| Drive Level | | 10 | 100 | μW | |
| Aging (1 year) | -2 | | +2 | ppm | @ 25°C±3°C |
| Insulation Resistance | 500 | | | MΩ | @ 100Vdc ± 15V |

IoT OPTIMIZED LOW PROFILE QUARTZ CRYSTAL

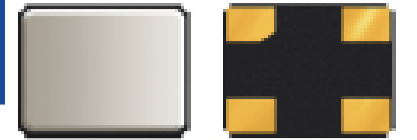

2.5 x 2.0 x 0.6mm



RoHS/RoHS II Compliant

MSL = N/A: NOT APPLICABLE

ABM10W SERIES

OPTIONS AND PART IDENTIFICATION (NOTE 1)

Note 1: Contact Abracon for part number requests with carrier frequency callouts up to 5 & 6 digit accuracy after the decimal.

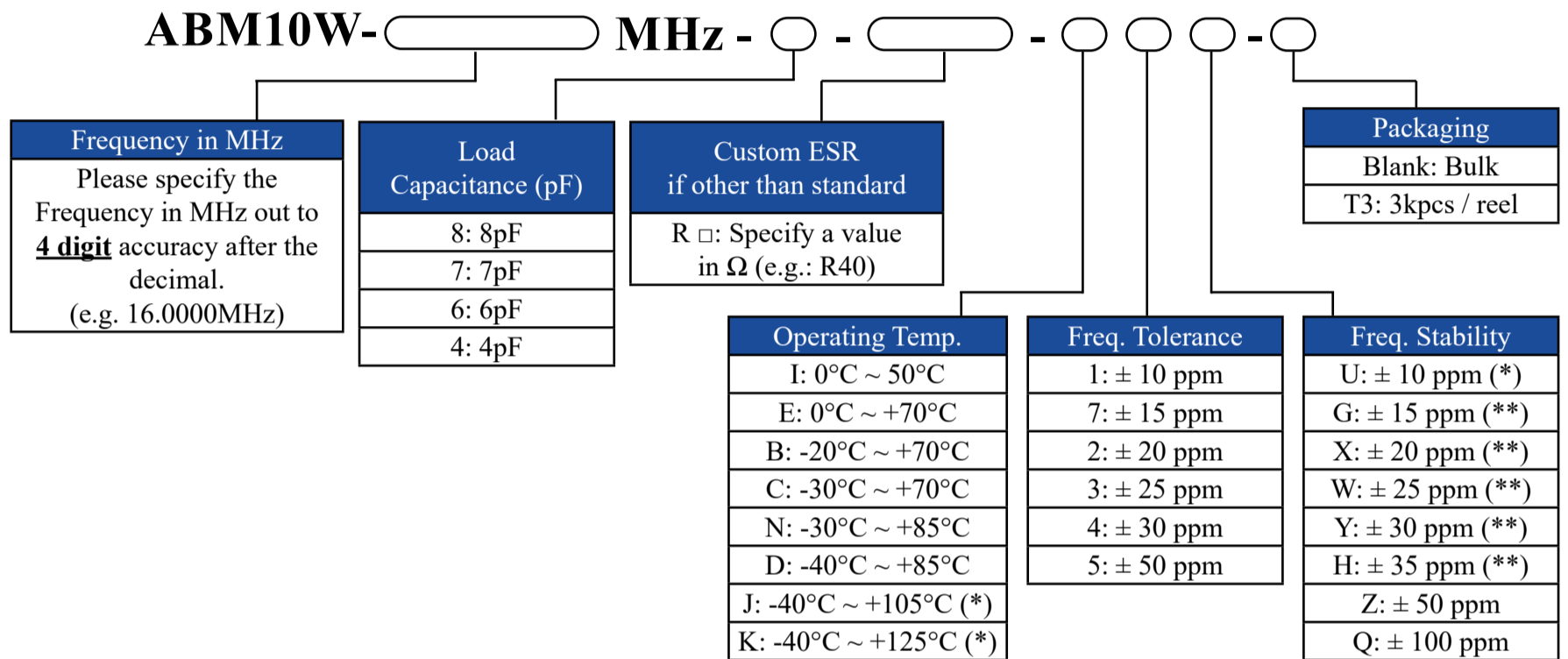

(*) Only offered @ Freq. Stability options: Z & Q.

Contact ABRACON for tighter Frequency Stability.

(*) Only offered @ Operating Temp. Range options: I, E, & B

(**) Only offered @ Operating Temp. Range options: I, E, B, C, N, & D

Contact ABRACON for wider Operating Temp. Range.

IoT OPTIMIZED LOW PROFILE QUARTZ CRYSTAL

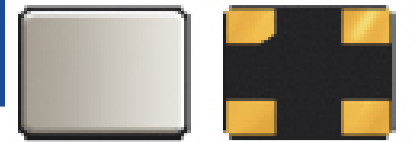

ABM10W SERIES

2.5 x 2.0 x 0.6mm



RoHS/RoHS II Compliant

MSL = N/A: NOT APPLICABLE

TYPICAL FREQUENCY Vs. TEMPERATURE CHARACTERISTICS

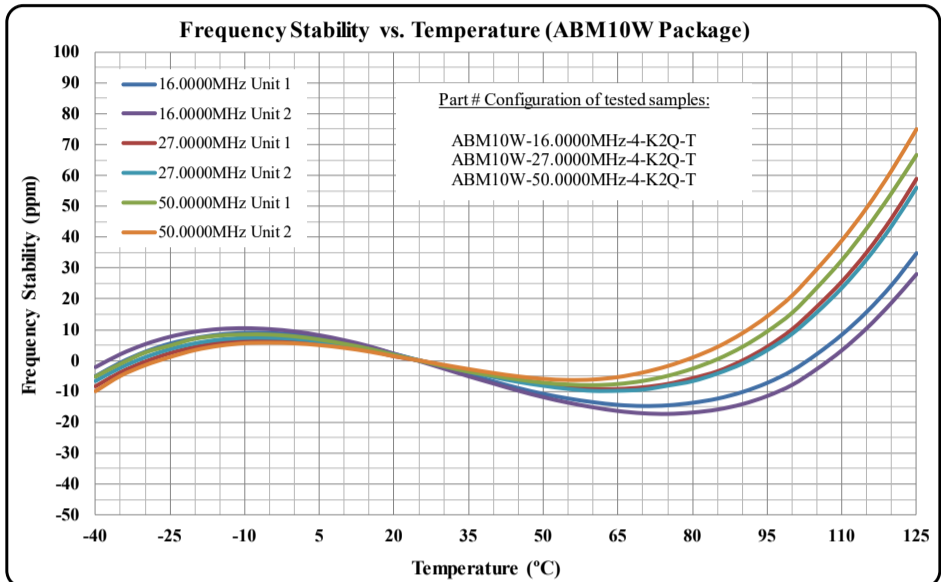
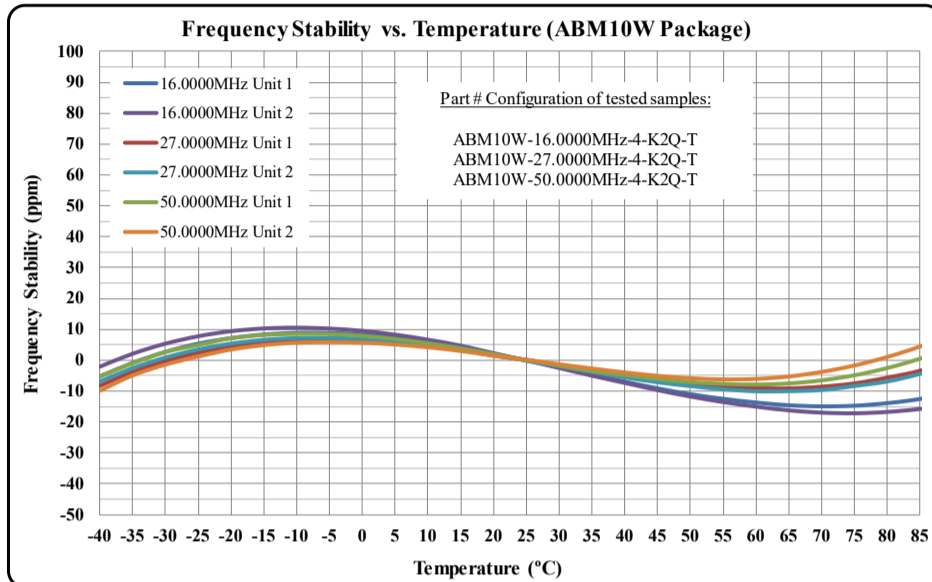

TYPICAL ESR (EQUIVALENT SERIES RESISTANCE) Vs. TEMPERATURE CHARACTERISTICS

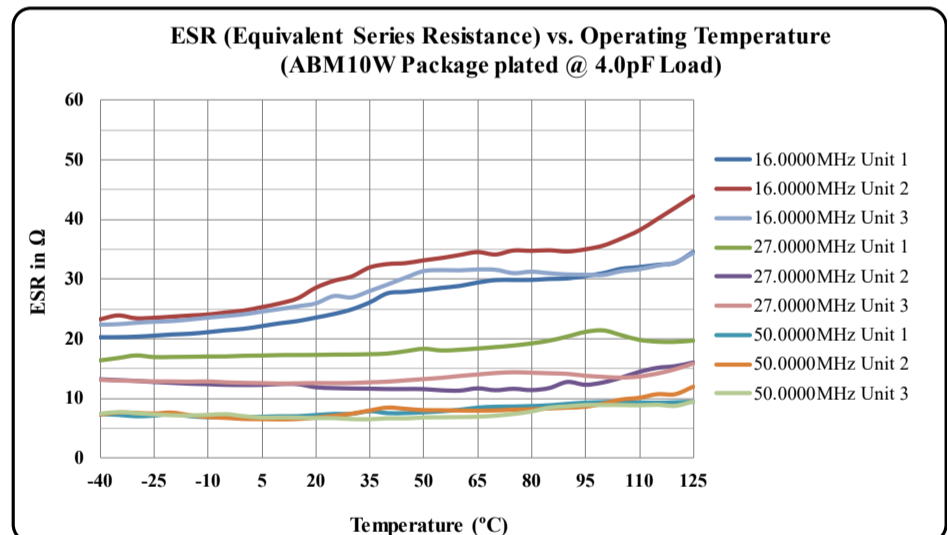
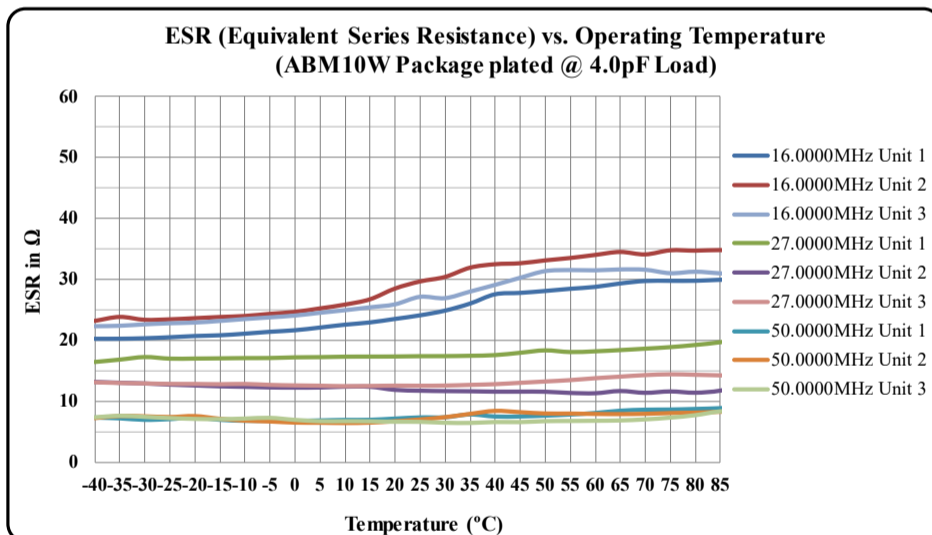

(*) Plating Load = Load Capacitance (CL)



5101 Hidden Creek Ln Spicewood TX 78669
 Phone: 512-371-6159 | Fax: 512-351-8858
 For terms and conditions of sales, please visit:
www.abracon.com

REVISED: 10.06.2020

ABRACON IS
 ISO9001-2015
 CERTIFIED

IoT OPTIMIZED LOW PROFILE QUARTZ CRYSTAL

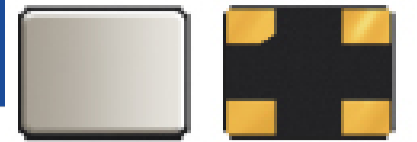

ABM10W SERIES

2.5 x 2.0 x 0.6mm



RoHS/RoHS II Compliant

MSL = N/A: NOT APPLICABLE

TYPICAL FREQUENCY TOLERANCE DISTRIBUTION (AT 25°C ± 3°C)

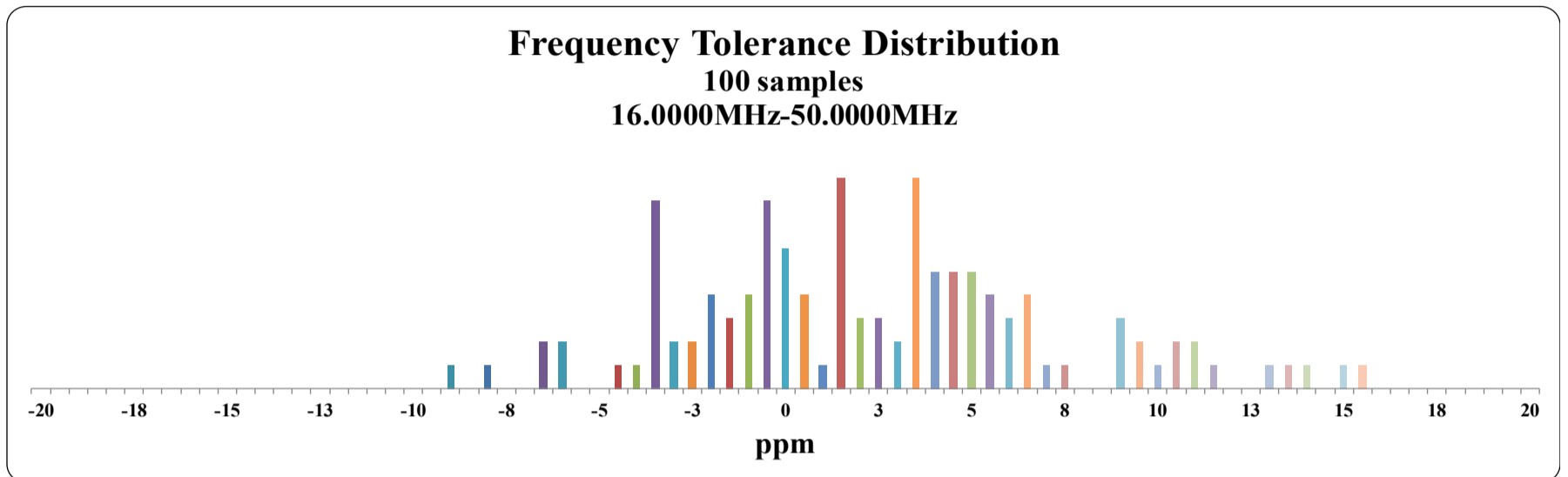

TYPICAL ESR DISTRIBUTION (AT 25°C ± 3°C)

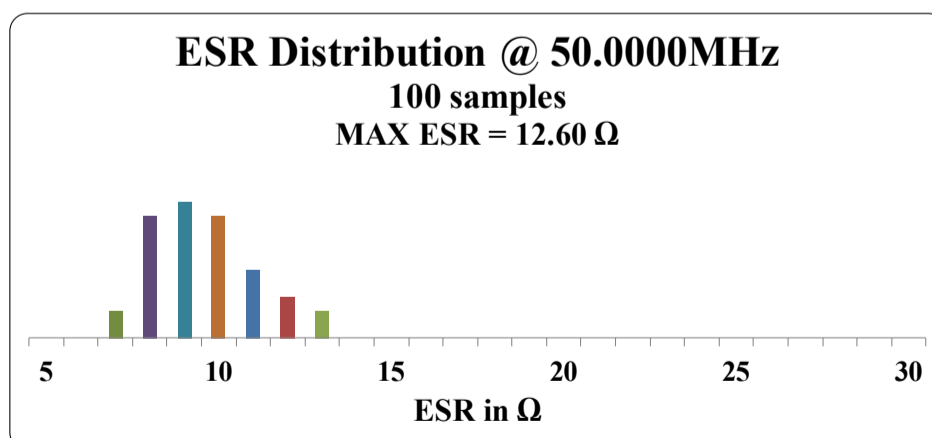
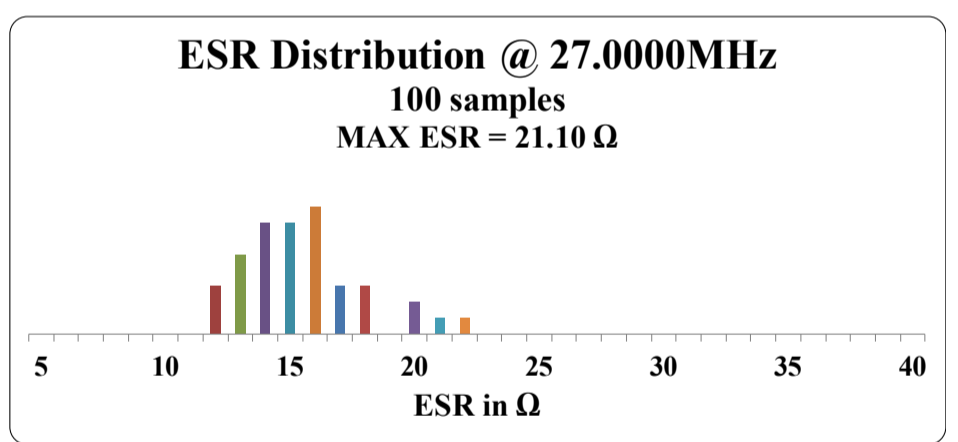
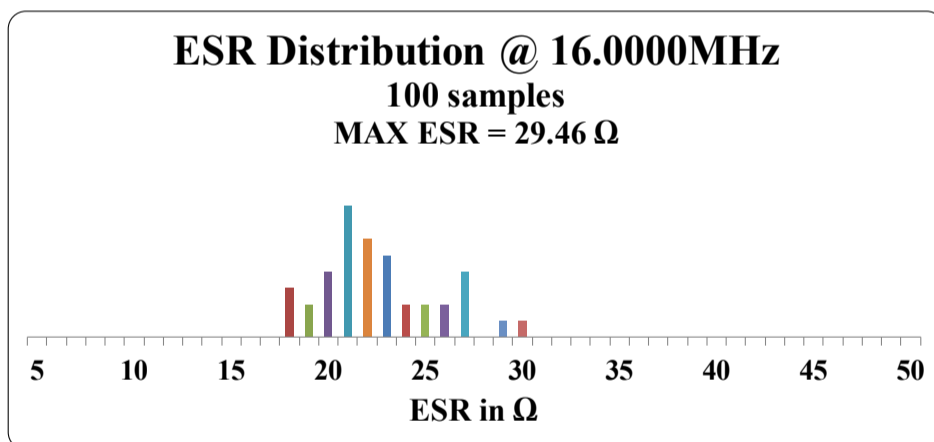

IoT OPTIMIZED LOW PROFILE QUARTZ CRYSTAL

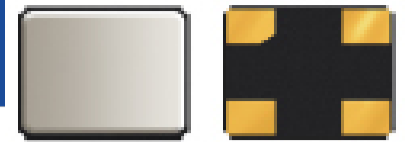

ABM10W SERIES

2.5 x 2.0 x 0.6mm



RoHS/RoHS II Compliant

MSL = N/A: NOT APPLICABLE

SPICE MODELS (BASED ON TYPICAL VALUES AT 25°C ± 3°C)

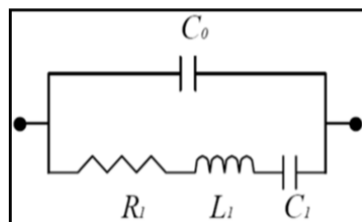

| | | | | | | | |
|------------------------------|---|-------|----|------------------------------|---|-------|----|
| Frequency: 16.0000MHz | | | | Frequency: 16.0000MHz | | | |
| Plating Load: 4pF | | | | Plating Load: 6pF | | | |
| C0 | = | 0.65 | pF | C0 | = | 0.65 | pF |
| R1 | = | 22.77 | Ω | R1 | = | 21.43 | Ω |
| L1 | = | 70.34 | mH | L1 | = | 70.13 | mH |
| C1 | = | 1.41 | fF | C1 | = | 1.41 | fF |
| Frequency: 27.0000MHz | | | | Frequency: 27.0000MHz | | | |
| Plating Load: 4pF | | | | Plating Load: 6pF | | | |
| C0 | = | 0.65 | pF | C0 | = | 0.66 | pF |
| R1 | = | 14.39 | Ω | R1 | = | 17.38 | Ω |
| L1 | = | 16.51 | mH | L1 | = | 16.56 | mH |
| C1 | = | 2.11 | fF | C1 | = | 2.10 | fF |
| Frequency: 50.0000MHz | | | | Frequency: 50.0000MHz | | | |
| Plating Load: 4pF | | | | Plating Load: 6pF | | | |
| C0 | = | 0.89 | pF | C0 | = | 0.87 | pF |
| R1 | = | 8.40 | Ω | R1 | = | 8.03 | Ω |
| L1 | = | 3.24 | mH | L1 | = | 3.19 | mH |
| C1 | = | 3.13 | fF | C1 | = | 3.18 | fF |

MECHANICAL DIMENSIONS

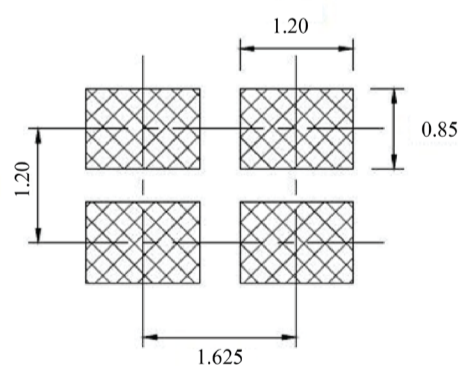
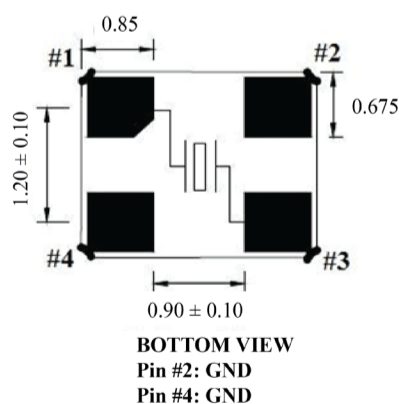
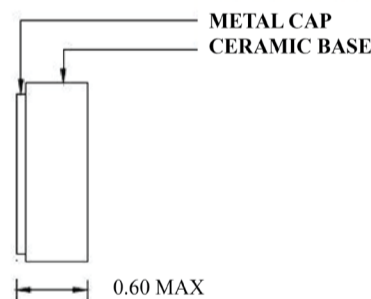
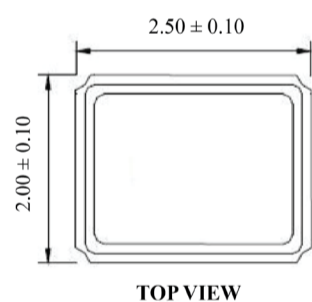

DIMENSIONS: mm

DIMENSIONS: mm

Note:

Due to material availability the Chamfer could be located on pin #1, 2 or 4. Be advised that the Chamfer location has no impact on the electrical performance of the device.

IoT OPTIMIZED LOW PROFILE QUARTZ CRYSTAL

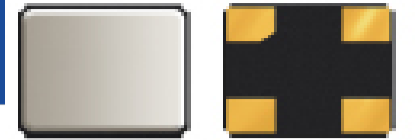

ABM10W SERIES

2.5 x 2.0 x 0.6mm



RoHS/RoHS II Compliant

MSL = N/A: NOT APPLICABLE

REFLOW PROFILE

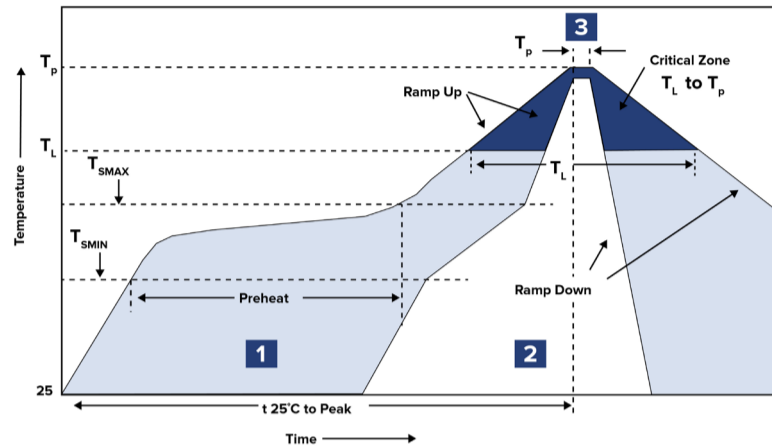

| Zone | Description | Temperature | Time |
|------|-------------|---|---------------|
| 1 | Preheat | $T_{SMIN} \sim T_{SMAX}$ 150°C ~ 180°C | 60 ~ 120 sec. |
| 2 | Reflow | T_L 217°C | 45 ~ 90 sec. |
| 3 | Peak Heat | T_P 260°C MAX | 10 sec. |

PACKAGING

T3: Tape and reel (3,000 pcs/reel)

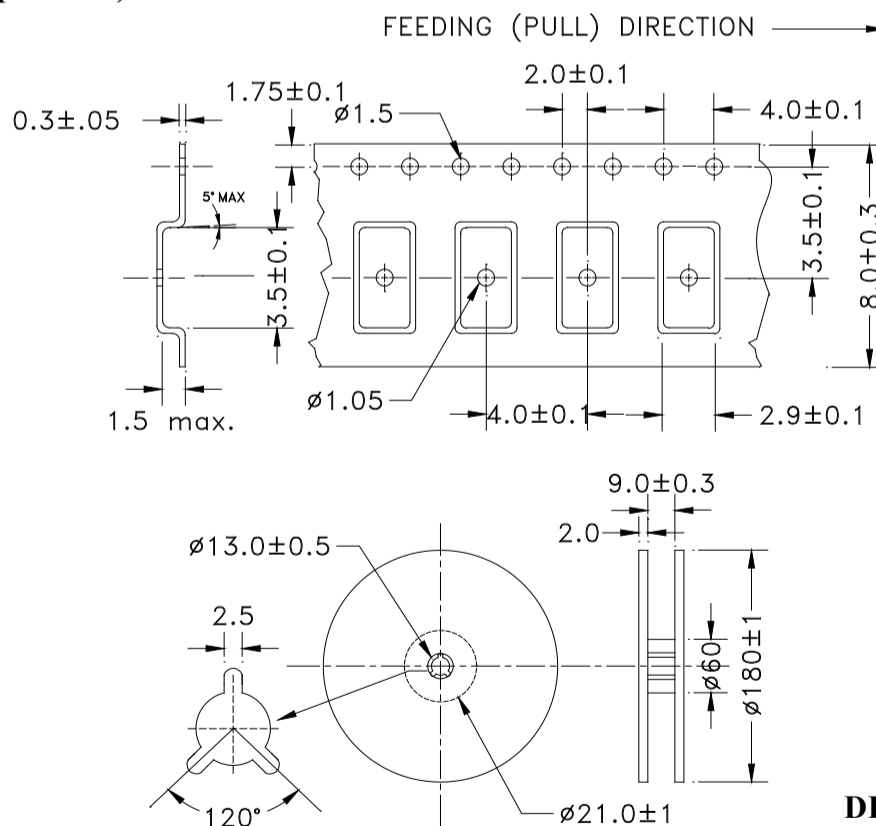

DIMENSIONS:mm



5101 Hidden Creek Ln Spicewood TX 78669
 Phone: 512-371-6159 | Fax: 512-351-8858
 For terms and conditions of sales, please visit:
www.abracon.com

REVISED: 10.06.2020

ABRACON IS
 ISO9001-2015
 CERTIFIED