

Programmable Controllers

CJ1

The CJ1 Expands the World of Machine Control!



» Flexible !

» Fast !

» Small !

The Fast, Small, and Flexible CJ1 the World of Machine Control!

Fast!

Versatile Machine Control with the Highest Performance Standards in the Industry.



Upgraded Basic Functions

Small!

Super-compact design that meets the highest standards in its class. Even a narrow space in a machine serves as a control panel.



Height: 90 mm, Depth: 65 mm

Backplane-free structure for a flexible Rack width.

Smaller Units.

Expands

Flexible!

Suitable for essentially any application, from small device and temperature control, to large-scale control over networks.



Application-specific CPU Units

CPU Units are available for a variety of applications, such as CPU Units with built-in I/O, CPU Units with Ethernet function, or CPU Units for loop control.

Full Complement of I/O Units

From Basic I/O Units, Analog Units, and Position Control Units to Ethernet Units, any of the Units can be used with any of the CPU Units.

C O N T E N T S

Concept	2
System Design Guide	5
■ System Configuration	6
■ Dimensions	10
■ General Specifications	13
■ Common Specifications for CPU Units	15
■ CJ1M-CPU2□ (CJ1M CPU with Built-in I/O) Specifications	19
■ CJ1M-CPU1□-ETN (CJ1M CPU with Ethernet function) Specifications	
■ CJ1G-CPU□□P (Loop-control CPU Units) Specifications	22
■ Checking Current Consumption and Power Consumption	23
Ordering Information	25
■ Basic Configuration Units	26
■ Programming Devices	31
■ Optional Products and Maintenance Products	34
■ DIN Track Accessories	34
■ Basic I/O Units	35
■ Special I/O Units and CPU Bus Units	39

New CJ2 series introduction

With the base of CJ1 series, CJ2 series with advanced functions has been released. The CJ2 series will easily innovate your systems widely ranging from compact machinery to high-speed and highly precise systems. Refer to the catalog (Cat No. P059) for details.

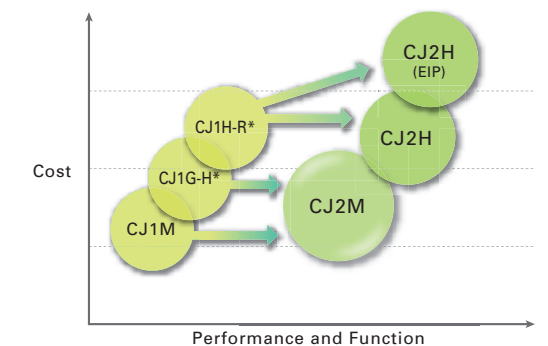

* Including models whose production were discontinued.

Programmable Controller
SYSMAC CJ1

System Design Guide

System Configuration	6
Dimensions	10
General Specifications	13
Common Specifications for CPU Units Specifications	15
CJ1M-CPU2□ (CJ1M CPU with Built-in I/O) Specifications	19
CJ1M-CPU1□-ETN (CJ1M CPU with Ethernet Function) Specifications	22
CJ1G-CPU□□P (Loop-control CPU Units) Specifications	22
Checking Current Consumption and Power Consumption	23

System Configuration

Basic System

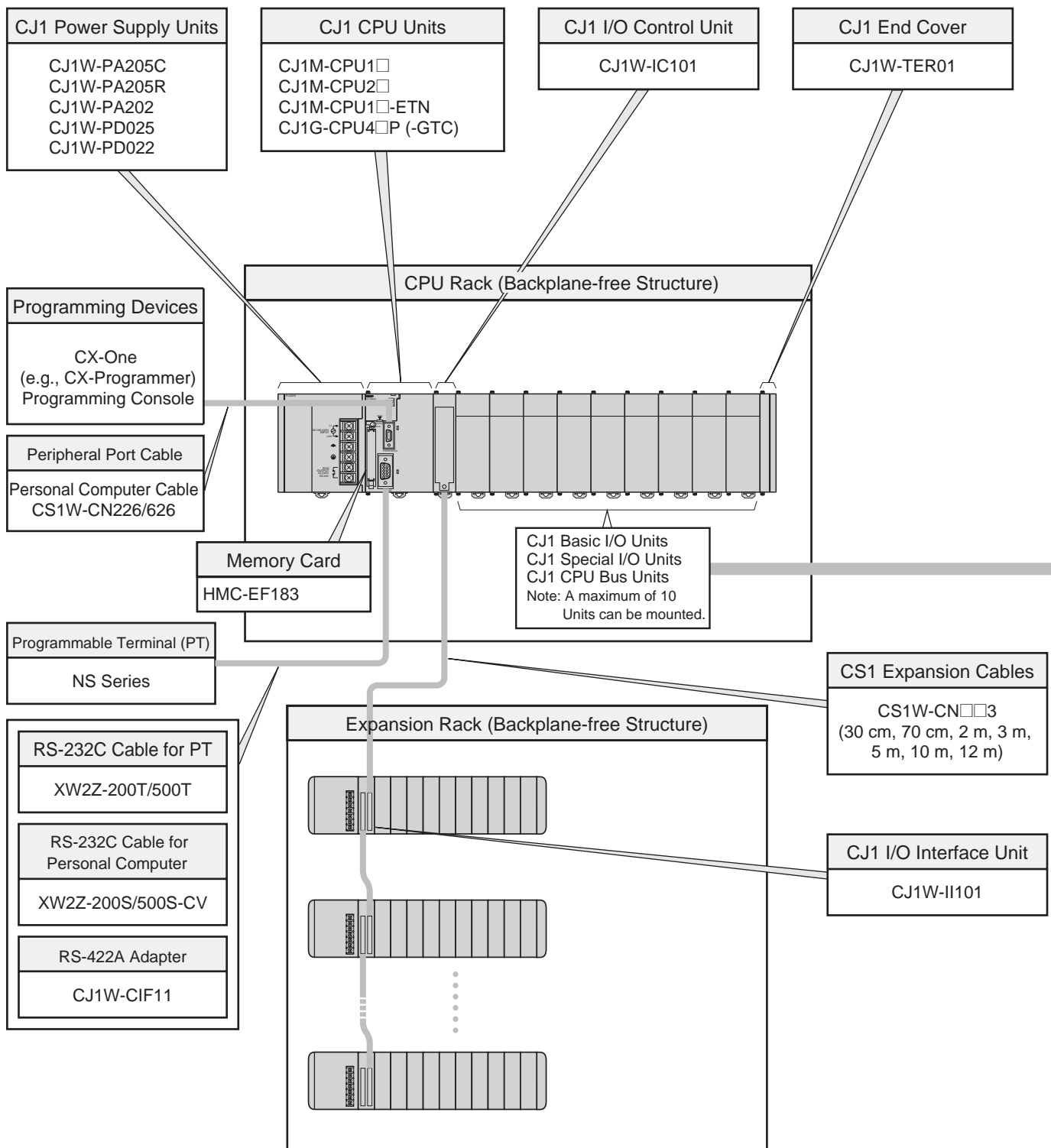

■ Configuration Units

CJ1 Basic I/O Units			
8-point Units	16-point Units	32-point Units	64-point Units
Input Units			
<ul style="list-style-type: none"> ● DC Input Unit CJ1W-ID201 ● AC Input Unit CJ1W-IA201 	<ul style="list-style-type: none"> ● DC Input Unit CJ1W-ID211 CJ1W-ID212 High-speed type ● AC Input Unit CJ1W-IA111 	<ul style="list-style-type: none"> ● DC Input Unit CJ1W-ID231 CJ1W-ID232 CJ1W-ID233 High-speed type 	<ul style="list-style-type: none"> ● DC Input Unit CJ1W-ID261 CJ1W-ID262
Output Units			
<ul style="list-style-type: none"> ● Relay Contact Output Unit (independent commons) CJ1W-OC201 ● Triac Output Unit CJ1W-OA201 ● Transistor Output Units CJ1W-OD201 CJ1W-OD202 CJ1W-OD203 CJ1W-OD204 	<ul style="list-style-type: none"> ● Relay Contact Output Unit CJ1W-OC211 ● Transistor Output Units CJ1W-OD211 CJ1W-OD213 High-speed type CJ1W-OD212 	<ul style="list-style-type: none"> ● Transistor Output Units CJ1W-OD231 CJ1W-OD233 CJ1W-OD234 High-speed type CJ1W-OD232 	<ul style="list-style-type: none"> ● Transistor Output Units CJ1W-OD261 CJ1W-OD263 CJ1W-OD262
I/O Units			
---	---	(16 inputs, 16 outputs) <ul style="list-style-type: none"> ● DC Input/Transistor Output Units CJ1W-MD231 CJ1W-MD233 CJ1W-MD232 	32 inputs, 32 outputs <ul style="list-style-type: none"> ● DC Input/Transistor Output Units CJ1W-MD261 CJ1W-MD263 32 inputs, 32 outputs <ul style="list-style-type: none"> ● TTL I/O Unit CJ1W-MD563
Other Units			
---	<ul style="list-style-type: none"> ● Interrupt Input Unit CJ1W-INT01 	---	<ul style="list-style-type: none"> ● B7A Interface Units (64 inputs) CJ1W-B7A14 (64 outputs) CJ1W-B7A04 (32 inputs, 32 outputs) CJ1W-B7A22

CJ1 Special I/O Units and CPU Bus Units			
<ul style="list-style-type: none"> ■ Process I/O Units ● Isolated-type Units with Universal Inputs CJ1W-PH41U CJ1W-AD04U ● Isolated-type Thermocouple Input Units CJ1W-PTS15 CJ1W-PTS51 ● Isolated-type Resistance Thermometer Input Units CJ1W-PTS16 CJ1W-PTS52 ● Isolated-type DC Input Unit CJ1W-PDC15 ■ Analog I/O Units ● Analog Input Units CJ1W-AD042 High-speed type CJ1W-AD081-V1 CJ1W-AD041-V1 ● Analog Output Units CJ1W-DA042V High-speed type CJ1W-DA08V CJ1W-DA08C CJ1W-DA041 CJ1W-DA021 ● Analog I/O Units CJ1W-MAD42 ■ Temperature Control Units CJ1W-TC001, CJ1W-TC002 CJ1W-TC003, CJ1W-TC004 CJ1W-TC101, CJ1W-TC102 CJ1W-TC103, CJ1W-TC104 	<ul style="list-style-type: none"> ■ High-speed Counter Units CJ1W-CT021 ■ Position Control Units CJ1W-NC214 High-speed type CJ1W-NC414 High-speed type CJ1W-NC234 High-speed type CJ1W-NC434 High-speed type CJ1W-NC113 CJ1W-NC213 CJ1W-NC413 CJ1W-NC133 CJ1W-NC233 CJ1W-NC433 ■ Position Control Unit with EtherCAT interface CJ1W-NC281 NEW CJ1W-NC481 NEW CJ1W-NC881 NEW CJ1W-NCF81 NEW CJ1W-NC482 NEW CJ1W-NC882 NEW ■ Position Control Unit with MECHATROLINK-II interface CJ1W-NC271 CJ1W-NC471 CJ1W-NCF71 CJ1W-NCF71-MA ■ Motion Control Unit with MECHATROLINK-II interface CJ1W-MCH71 	<ul style="list-style-type: none"> ■ Serial Communications Units CJ1W-SCU22 High-speed type CJ1W-SCU32 High-speed type CJ1W-SCU42 High-speed type CJ1W-SCU21-V1 CJ1W-SCU31-V1 CJ1W-SCU41-V1 ■ EtherNet/IP Unit CJ1W-EIP21 ■ Ethernet Unit CJ1W-ETN21 ■ Controller Link Units CJ1W-CLK23 ■ FL-net Unit CJ1W-FLN22 ■ DeviceNet Unit CJ1W-DRM21 ■ CompoNet Master Unit CJ1W-CRM21 ■ CompoBus/S Master Unit CJ1W-SRM21 	<ul style="list-style-type: none"> ■ ID Sensor Units CJ1W-V680C11 CJ1W-V680C12 CJ1W-V600C11 CJ1W-V600C12
			<ul style="list-style-type: none"> ■ High-speed Data Storage Unit CJ1W-SPU01-V2

Note: Windows is a registered trademark of Microsoft Corporation in the USA. MECHATROLINK II is a registered trademark of the MECHATROLINK Members Association. Other company names and product names etc. are the trademarks or registered trademarks of their respective companies.

■ CJ-series CPU Racks

A CJ-series CPU Rack consists of a CPU Unit, Power Supply Unit, Configuration Units (Basic I/O Units, Special I/O Units, and CPU Bus Units), and an End Cover.

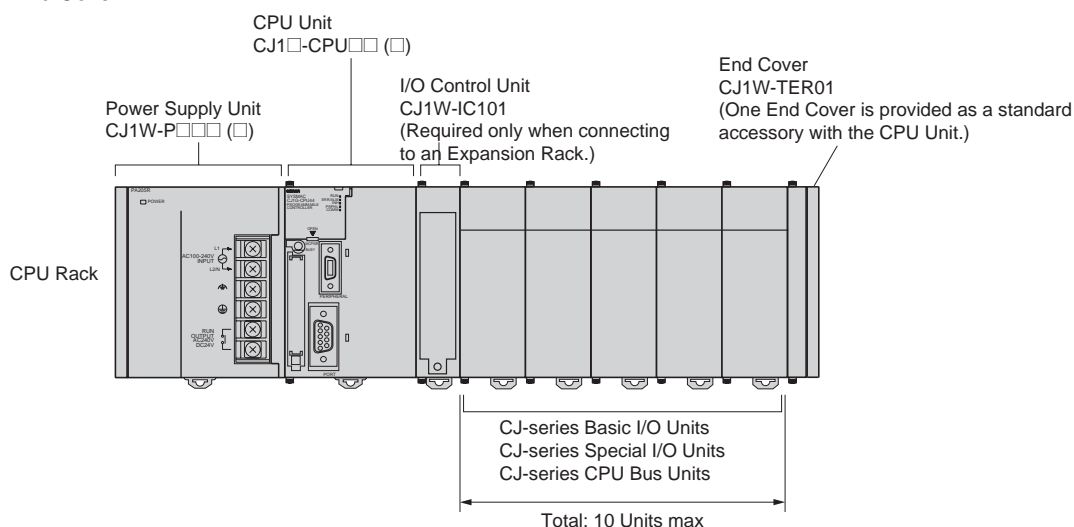

● Required Units

Rack	Unit name	Required number of Units
CPU Rack	Power Supply Unit	1
	CPU Unit	1
	I/O Control Unit	Required only for mounting to an Expansion Rack.
	Number of Configuration Units	10 max. (Same for all models of CPU Unit.) (The number of Basic I/O Units, Special I/O Units, and CPU Bus Units can be varied. The number does not include the I/O Control Unit.)
	End Cover	1 (Included with CPU Unit.)

● Types of Units

In the SYSMAC CJ Series, Units are classified into the following three types. The number of Racks differs depending on the type.

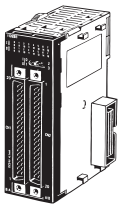
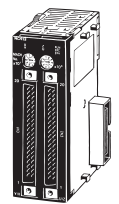
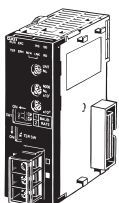
Type	Appearance (example)	Description	Unit recognition method	No. of Units
Basic I/O Units		Basic I/O Units with contact inputs and contact outputs.	Recognized by the CPU Unit according to the position of the Rack and slot.	No restrictions.
Special I/O Units		Special I/O Units provide more advanced functions than do Basic I/O Units, including I/O other than contact inputs and contact outputs. Examples of Special I/O Units are Analog I/O Units and High-speed Counter Units. They differ from CPU Bus Units (including Network Communications Units) in having a smaller area for exchanging data with the CPU Unit.	Recognized by the CPU Unit according to the unit number (0 to 95) set with the rotary switches on the front panel.	A maximum of 96 Units can be connected. (Multiple unit numbers are allocated per Unit, depending on the model and settings.)
CPU Bus Units		CPU Bus Units exchange data with the CPU Unit via the CPU Bus. Examples of CPU Bus Units are Network Communications Units and Serial Communications Units. They differ from Special I/O Units in having a larger area for exchanging data with the CPU Unit.	Recognized by the CPU Unit according to the unit number (0 to F) set with the rotary switch on the front panel.	A maximum of 16 Units can be mounted. (See note.)

Note: CJ1M-CPU□□-ETN: A Maximum of 15 Units can be mounted. (The built-in Ethernet port on the CPU Unit must be allocated as one of the CPU Bus Units)

■ CJ-series Expansion Racks

A CJ-series Expansion Rack consists of a Power Supply Unit, an I/O Interface Unit, Configuration Units (Basic I/O Units, Special I/O Units, and CPU Bus Units), and an End Cover.

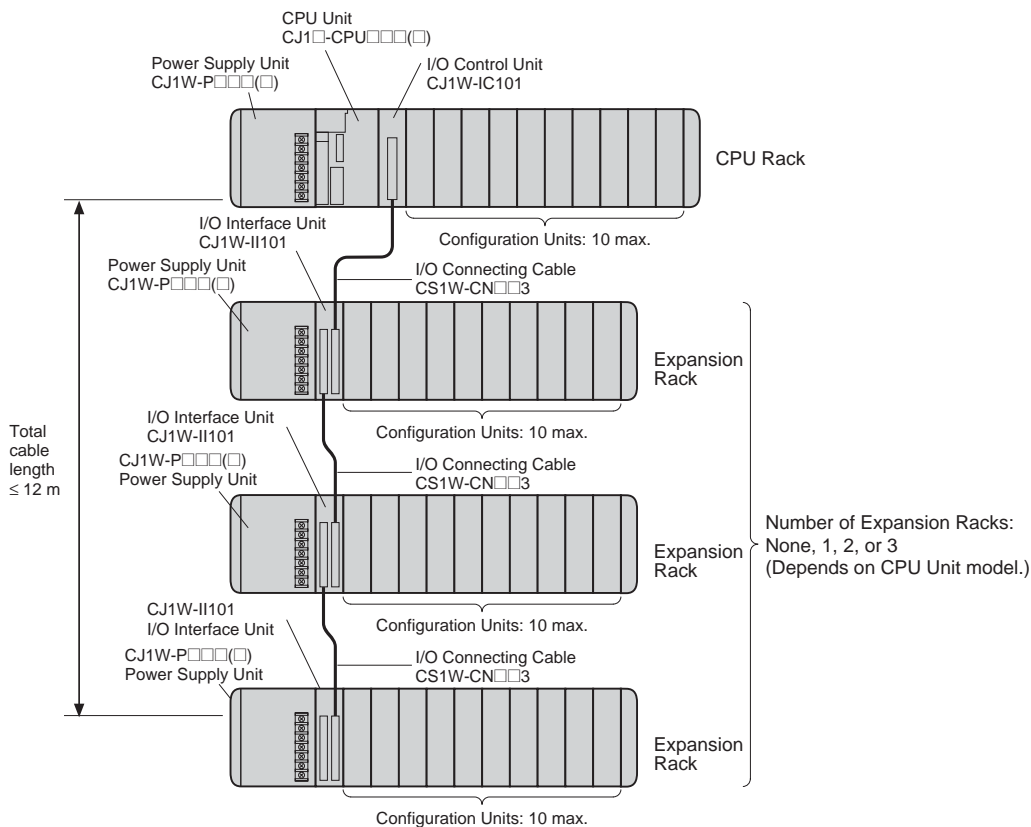

● Required Units

Rack	Unit name	Required number of Units
CPU Rack	I/O Control Unit	One Unit. Required only when an Expansion Rack is used. Mount the I/O Control Unit immediately to the right of the CPU Unit. (See note 1.)
Expansion Rack	Power Supply Unit	One Unit
	I/O Interface Unit	One Unit. Mount the I/O Interface Unit immediately to the right of the Power Supply Unit. (See note 2.)
	Number of Configuration Units	Ten Units max. (The number of Basic I/O Units, Special I/O Units, and CPU Bus Units can be varied. This number does not include the I/O Interface Unit.)
	End Cover	One (Included with the I/O Interface Unit.)

- Note 1.** Mounting the I/O Control Unit in any other location may cause faulty operation.
Note 2. Mounting the I/O Interface Unit in any other location may cause faulty operation.

● Maximum Number of Configuration Units That Can Be Mounted

CPU Unit	Model	Total Units	No. of Units on CPU Rack	No. of Expansion Racks
CJ1G	CJ1G-CPU45P (-GTC)	40	10 per Rack	3 Racks x 10 Units
	CJ1G-CPU44P			
	CJ1G-CPU43P	30	10 per Rack	2 Racks x 10 Units
	CJ1G-CPU42P			
CJ1M	CJ1M-CPU13 (-ETN)	20	10 per Rack (See note.)	1 Rack x 10 Units
	CJ1M-CPU23			
	CJ1M-CPU12 (-ETN)	10	10 per Rack (See note.)	Cannot be connected.
	CJ1M-CPU11 (-ETN)			
	CJ1M-CPU22			
	CJ1M-CPU21			

Note: Up to nine Units can be connected to a CJ1M-CPU1□-ETN CPU Units. The maximum number of Configuration Units that can be connected is thus reduced by 1.

Dimensions

Note: Units are in mm unless specified otherwise.

Product Dimensions

Example Rack Widths using CJ1WPA202 Power Supply Unit (AC, 14 W)

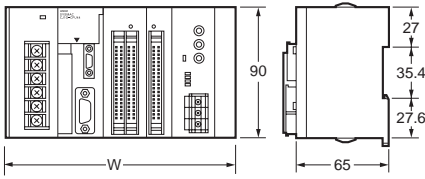

No. of Units mounted with 31-mm width	Rack width (mm)			
	With CJ1M-CPU11/12/13	With CJ1M-CPU21/22/23	With CJ1M-CPU1□-ETN	With CJ1G-CPU4□P(-GTC) CPU Unit
1	121.7	139.7	152.7	159.7
2	152.7	170.7	183.7	190.7
3	183.7	201.7	214.7	221.7
4	214.7	232.7	245.7	252.7
5	245.7	263.7	276.7	283.7
6	276.7	294.7	307.7	314.7
7	307.7	325.7	338.7	345.7
8	338.7	356.7	369.7	376.7
9	369.7	387.7	400.7	407.7
10	400.7	418.7	431.7	438.7

Power Supply Units, CPU Units, and End Covers

Unit/product	Model	Width
Power Supply Unit	CJ1W-PA205C	80
	CJ1W-PA205R	80
	CJ1W-PA202	45
	CJ1W-PD025	60
	CJ1W-PD022	27
CPU Unit	CJ1M-CPU1□	31
	CJ1M-CPU2□	49
	CJ1M-CPU1□-ETN	62
	CJ1G-CPU4□P	69
End Cover	CJ1W-TER01	14.7

Power Supply Units

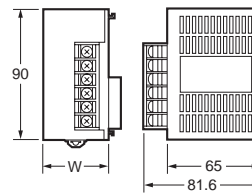

W=27: CJ1W-PD022
 W=45: CJ1W-PA202
 W=80: CJ1W-PA205R
 CJ1W-PA205C
 W=60: CJ1W-PD025

End Cover (included with CPU Units)

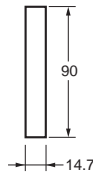

RS-422A Adapter CJ1W-CIF11

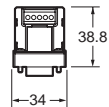

CPU Units

CJ1G-CPU4□P

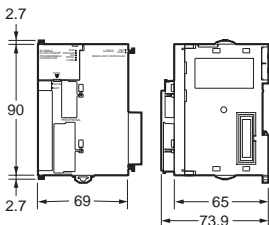

CJ1M-CPU1□

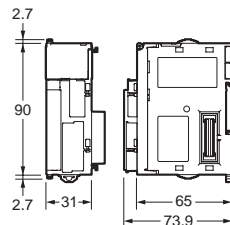

CJ1M-CPU1□-ETN

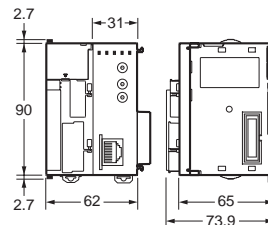

CJ1M-CPU2□

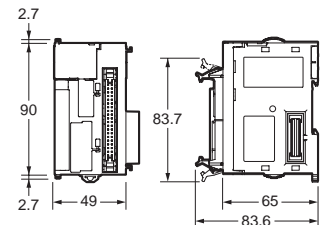

● Units of Width 20 mm

Unit/product	Model	Width
I/O Control Unit	CJ1W-IC101	20
32-point Basic I/O Units	CJ1W-ID231/232/233	
	CJ1W-OD231/232/233/234	
B7A Interface Unit	CJ1W-B7A22 CJ1W-B7A14 CJ1W-B7A04	
CompoBus/S Master Unit	CJ1W-SRM21	
Space Unit	CJ1W-SP001	

● I/O Control Unit

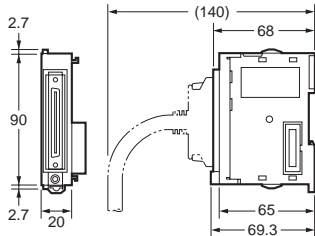

● 32-Point I/O Units (CJ1W-ID223□/OD23□)

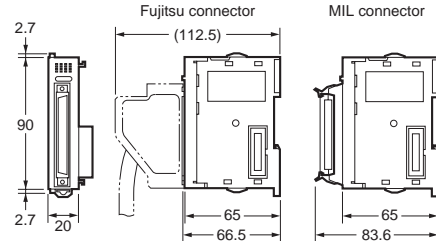

● Units of Width 31 mm

Unit	Model	Width
I/O Interface Unit	CJ1W-II101	31
8/16-point Basic I/O Units	CJ1W-ID201	
	CJ1W-ID211/212	
	CJ1W-IA111/201	
	CJ1W-OD20□	
	CJ1W-OD211/212/213	
	CJ1W-OC201/211	
CJ1W-OA201		
32-point Basic I/O Units	CJ1W-MD231	
	CJ1W-MD232/233	
64-point Basic I/O Units	CJ1W-ID261	
	CJ1W-OD261	
	CJ1W-MD261	
	CJ1W-ID262	
	CJ1W-OD262/263	
CJ1W-MD263		
CJ1W-MD563		
Interrupt Input Unit	CJ1W-INT01	
High-speed Input Unit	CJ1W-IDP01	
Analog I/O Units	CJ1W-AD□□□□(-V1)	
	CJ1W-DA□□□□(□)	
	CJ1W-MAD42	
Process Input Units	CJ1W-PH41U	
	CJ1W-AD04U	
	CJ1W-PTS51/52/15/16	
	CJ1W-PDC15	
Temperature Control Units	CJ1W-TC□□□□	
Position Control Units	CJ1W-NC113/133	
	CJ1W-NC213/233	
	CJ1W-NC413/433	

Unit	Model	Width
Position Control Units with EtherCAT interface	CJ1W-NC281	31
	CJ1W-NC481	
	CJ1W-NC881	
	CJ1W-NCF81	
	CJ1W-NC482	
CJ1W-NC882		
Position Control Unit with MECHATROLINK-II interface	CJ1W-NC271	
	CJ1W-NC471	
	CJ1W-NCF71	
CJ1W-NCF71-MA		
High-speed Counter Unit	CJ1W-CT021	
ID Sensor Units	CJ1W-V680C11	
	CJ1W-V680C12	
	CJ1W-V600C11	
	CJ1W-V600C12	
Controller Link Units	CJ1W-CLK23	
Serial Communications Units	CJ1W-SCU22	
	CJ1W-SCU32	
	CJ1W-SCU42	
	CJ1W-SCU41-V1	
	CJ1W-SCU21-V1	
CJ1W-SCU31-V1		
EtherNet/IP Unit	CJ1W-EIP21	
Ethernet Unit	CJ1W-ETN21	
DeviceNet Unit	CJ1W-DRM21	
CompoNet Master Unit	CJ1W-CRM21	
FL-net Unit	CJ1W-FLN22	

● I/O Interface Unit

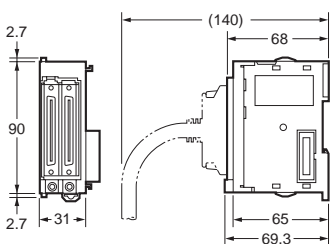

● 8/16-point Basic I/O Units, Interrupt Input Unit, and High-speed Input Unit

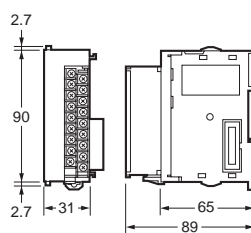

● 64-point Basic I/O Units and 32-point Basic I/O Units (CJ1W-MD23□)

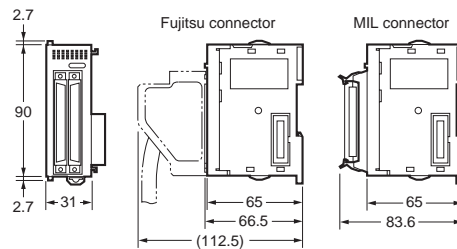

● Special I/O Units and CPU Bus Units

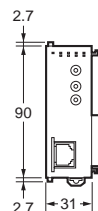

● Unit of Width 51 mm

Unit	Model	Width
SYSMAC SPU (High-speed Data Storage Unit)	CJ1W-SPU01-V2	51
Position Control Units (High-speed type)	CJ1W-NC214/234	

● SYSMAC SPU (High-speed Data Storage Unit)
CJ1W-SPU01-V2

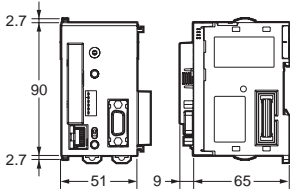

● Unit of Width 79.8 mm

Unit	Model	Width
Motion Control Unit with MECHATROLINK-II interface	CJ1W-MCH71	79.8

● Motion Control Unit with MECHATROLINK-II interface
CJ1W-MCH71

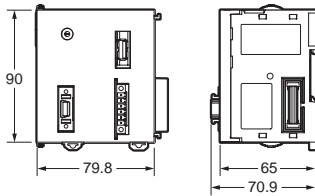

■ Mounting Dimensions

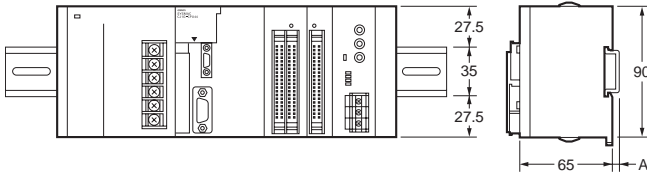

DIN Track model number	A
PFP-100N2	16 mm
PFP-100N	7.3 mm
FPP-50N	7.3 mm

● Unit of Width 62 mm

Unit	Model	Width
Position Control Units (High-speed type)	CJ1W-NC414/434	62

● Position Control Unit (High-speed model)
CJ1W-NC414/434

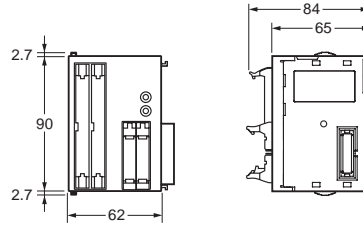

■ Mounting Height

The mounting height of CJ-series CPU Racks and Expansion Racks is from 81.6 to 89.0 mm depending on the Units that are mounted.

Additional height is required to connect Programming Devices (e.g., CX-Programmer or Programming Console) and Cables. Be sure to allow sufficient mounting height.

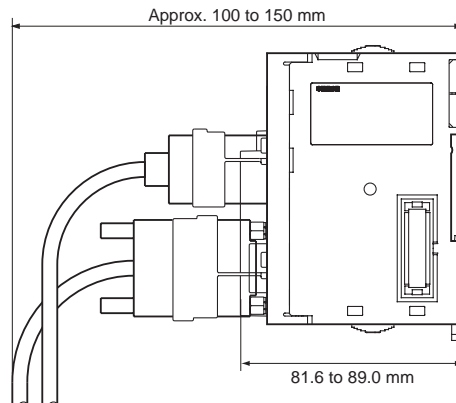

Note: Consider the following points when expanding the configuration:
The total length of I/O Connecting Cable must not exceed 12 m.
I/O Connecting Cables require the bending radius indicated below.

● CJ-series Connecting Cable

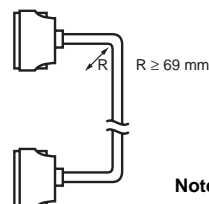

Note: Outer diameter of cable: 8.6 mm.

General Specifications

Item	Specifications				
	CJ1W-PA205R	CJ1W-PA205C	CJ1W-PA202	CJ1W-PD025	CJ1W-PD022
Power Supply Unit					
Supply voltage	100 to 240 V AC (wide-range), 50/60 Hz			24 VDC	
Operating voltage and frequency ranges	85 to 264 V AC, 47 to 63 Hz			19.2 to 28.8 V DC	21.6 to 26.4 V DC
Power consumption	100 VA max.		50 VA max.	50 W max.	35 W max.
Inrush current (See note 1.)	At 100 to 120 V AC: 15 A/8 ms max. for cold start at room temperature At 200 to 240 V AC: 30 A/8 ms max. for cold start at room temperature		At 100 to 120 V AC: 20 A/8 ms max. for cold start at room temperature At 200 to 240 V AC: 40 A/8 ms max. for cold start at room temperature	At 24 V DC: 30 A/20 ms max. for cold start at room temperature	
Output capacity (See note 7.)	5.0 A, 5 V DC (including supply to CPU Unit)		2.8 A, 5 V DC (including supply to CPU Unit)	5.0 A, 5 V DC (including supply to CPU Unit)	2.0 A, 5 V DC (including supply to CPU Unit)
	0.8 A, 24 V DC		0.4 A, 24 V DC	0.8 A, 24 V DC	0.4 A, 24 V DC
	Total: 25 W max.		Total: 14 W max.	Total: 25 W max.	Total: 19.6 W max.
Output terminal (service supply)	Not provided.				
RUN output (See note 2.)	Contact configuration: SPST-NO Switch capacity: 250 V AC, 2 A (resistive load) 120 V AC, 0.5 A (inductive load), 24 V DC, 2A (resistive load) 24 V DC, 2 A (inductive load)	Not provided.			
Replacement notification function	Not provided.	With Alarm output (open-collector output) 30 V DC max., 50 mA max.	Not provided.		
Insulation resistance	20 MΩ min. (at 500 V DC) between AC external and GR terminals (See note 3.)	<ul style="list-style-type: none"> 20 MΩ min. (at 500 V DC) between all external terminals and GR terminal (See note 3.), and between all alarm output terminals. 20 MΩ 1 min. (at 250 V DC) between all alarm output terminals and GR terminal (See note 3.). 	20 MΩ min. (at 500 V DC) between AC external and GR terminals (See note 3.)	20 MΩ min. (at 500 V DC) between DC external and GR terminals (See note 3.)	--- (See note 6.)
Dielectric strength (See note 4.)	2,300 V AC 50/60 Hz for 1 min between AC external and GR terminals (See note 3.) Leakage current: 10 mA max.	<ul style="list-style-type: none"> 2,300 V AC, 50/60 Hz for 1 minute between all external terminals and GR terminal (See note 3.) and between all alarm output terminals with a leakage current of 10 mA max. 1,000 V AC, 50/60 Hz for 1 minute between all alarm output terminals and GR terminal (See note 3.) with a leakage current of 10 mA max. 	2,300 V AC 50/60 Hz for 1 min between AC external and GR terminals (See note 3.) Leakage current: 10 mA max.	1,000 V AC, 50/60 Hz for 1 minute between DC external and GR terminals (See note 3.) Leakage current: 10 mA max.	--- (See note 6.)
	1,000 V AC, 50/60 Hz for 1 minute between DC external and GR terminals (See note 3.) Leakage current: 10 mA max.				
Noise immunity	2 kV on power supply line (conforming to IEC61000-4-4)				
Vibration Resistance	Conforms to IEC60068-2-6 5 to 8.4 Hz with 3.5-mm amplitude, 8.4 to 150 Hz Acceleration of 9.8 m/s ² for 100 min in X, Y, and Z directions (10 sweeps of 10 min each = 100 min total)				
Shock Resistance	Conforms to IEC60068-2-27 147 m/s ² , 3 times in X, Y, and Z directions (100 m/s ² for Relay Output Units)				
Ambient operating temperature	0 to 55°C				
Ambient operating humidity	10% to 90% (with no condensation)	10% to 90% (with no condensation) (See note 5.)	10% to 90% (with no condensation)		
Atmosphere	Must be free from corrosive gases.				
Ambient storage temperature	-20 to 70°C (excluding battery)	-20 to 75°C (See note 5.)	-20 to 75°C (excluding battery)		
Grounding	Less than 100 Ω				
Enclosure	Mounted in a panel.				
Weight	All models are each 5 kg max.				

Item	Specifications				
	CJ1W-PA205R	CJ1W-PA205C	CJ1W-PA202	CJ1W-PD025	CJ1W-PD022
Power Supply Unit					
CPU Rack dimensions	90.7 to 466.7 × 90 × 65 mm (W × H × D) (not including cables) Note: $W = a + b + 20 \times n + 31 \times m + 14.7$ a: Power Supply Unit: PA205R and PA205C = 80; PA202 = 45; PD025 = 60; PD022=27 b: CPU Unit: CJ1-H or CJ1 = 62; CJ1M-CPU1□ = 31; CJ1M-CPU1□-ETN = 62; CJ1M-CPU2□ = 49 The total width is given by the following: $W = 156.7 + n \times 20 + m \times 31$, where n is the number of 32-point I/O Units or I/O Control Units and m is the number of other Units.				
Safety measures	Conforms to cULus and EC Directives.				

- Note 1.** Disconnect the Power Supply Units LG terminal from the GR terminal when testing insulation and dielectric strength. Testing the insulation and dielectric strength with the LG terminal and the GR terminals connected will damage internal circuits in the CPU Unit.
- Supported only when mounted to CPU Rack.
 - The inrush current is given for a cold start at room temperature. The inrush control circuit uses a thermistor element with a low-temperature current control characteristic. If the ambient temperature is high or the PLC is hot-started, the thermistor will not be sufficiently cool, and the inrush currents given in the table may be exceeded by up to twice the given values. When selecting fuses or breakers for external circuits, allow sufficient margin in shut-off performance.
 - Maintain an ambient storage temperature of -25 to 30°C and relative humidity of 25% to 70% when storing the Unit for longer than 3 months to keep the replacement notification function in optimum working condition.
 - Change the applied voltage gradually using the adjuster on the Tester. If the full dielectric strength voltage is applied or turned OFF using the switch on the Tester, the generated impulse voltage may damage the Power Supply Unit.
 - CJ1W-PD022 is not insulated between the primary DC power and secondary DC power.
 - Internal components in the Power Supply Unit will deteriorate or be damaged if the Power Supply Unit is used for an extended period of time exceeding the power supply output capacity or if the outputs are shorted.

Specifications

Common Specifications

Item		Specifications	
Control method		Stored program	
I/O control method		Cyclic scan and immediate processing are both possible.	
Programming Languages		Ladder Logic (LD), Sequential Function Charts (SFC), Structured Text (ST), and Mnemonic.	
CPU processing mode		CJ1M CPU Units: Normal Mode or Peripheral Servicing Priority Mode CJ1 CPU Units: Normal Mode or Peripheral Servicing Priority Mode	
Instruction length		1 to 7 steps per instruction	
Ladder instructions		Approx. 400 (3-digit function codes)	
Execution time	Basic instructions	CJ1M CPU Units (CPU12(-ETN)/13(-ETN)/22/23): CJ1M CPU Units (CPU11(-ETN)/21): CJ1 CPU Units:	0.10 μs min. 0.10 μs min. 0.08 μs min.
	Special instructions	CJ1M CPU Units (CPU12(-ETN)/13(-ETN)/22/23): CJ1M CPU Units (CPU11(-ETN)/21): CJ1 CPU Units:	0.15 μs min. 0.15 μs min. 0.12 μs min.
Overhead time		CJ1M CPU Units (CPU12(-ETN)/13(-ETN)/22/23): CJ1M CPU Units (CPU11(-ETN)/21): CJ1 CPU Units:	0.5 ms min. 0.7 ms min. 0.5 ms min.
Unit connection method		No Backplane: Units connected directly to each other.	
Mounting method		DIN Track (screw mounting not possible)	
Maximum number of connectable Units		<ul style="list-style-type: none"> CJ1M CPU Units: Total of 20 Units in the System, including 10 Units on CPU Rack and 10 Units on one Expansion Rack. CJ1M CPU Units (CPU1□-ETN): Total of 19 Units, including 9 Units on CPU Rack and 10 Units on one Expansion Rack. (The built-in Ethernet port on the CPU Unit must be allocated to a slots 0, and is counted as one Unit. 	
Maximum number of Expansion Racks		<ul style="list-style-type: none"> CJ1 CPU Units: 3 max. (An I/O Control Unit is required on the CPU Rack and an I/O Interface Unit is required on each Expansion Rack.) CJ1M CPU Units (CPU 13(-ETN)/23 only): 1 max. (An I/O Control Unit is required on the CPU Rack and an I/O Interface Unit is required on the Expansion Rack.) CJ1M CPU Units (CPU11(-ETN)/12(-ETN)/21/22): Expansion is not possible. 	
Number of tasks		288 (cyclic tasks: 32, interrupt tasks: 256) With CJ1M CPU Units, interrupt tasks can be defined as cyclic tasks called extra cyclic tasks. Including these, up to 288 cyclic tasks can be used. Note 1. Cyclic tasks are executed each cycle and are controlled with TKON(820) and TKOF(821) instructions. 2. The following 4 types of interrupt tasks are supported. Power OFF interrupt tasks: 1 max. Scheduled interrupt tasks: 2 max. I/O interrupt tasks: 32 max. External interrupt tasks: 256 max.	
Interrupt types		Scheduled Interrupts: Interrupts generated at a time scheduled by the CPU Units built-in timer. (See note. 1) I/O Interrupts: Interrupts from Interrupt Input Units. Power OFF Interrupts (See note 2.): Interrupts executed when the CPU Units power is turned OFF. External I/O Interrupts: Interrupts from the Special I/O Units or CPU Bus Units. Note 1. CJ1 CPU Units: Scheduled interrupt time interval is either 1 ms to 9,999 ms or 10 ms to 99,990 ms, in units of 1 ms or 10 ms. CJ1M CPU Units: In addition to the above, a scheduled interrupt time interval of 0.5 ms to 999.9 ms, in units of 0.1 ms, is also possible. 2. Not supported when the CJ1W-PD022 Power Supply Unit is mounted.	
CIO (Core I/O) Area	I/O Area	2,560 (CIO 000000 to CIO 015915 (160 words from CIO 0000 to CIO 0159) The setting of the first word can be changed from the default (CIO 0000) so that CIO 0000 to CIO 0999 can be used. I/O bits are allocated to Basic I/O Units.	The CIO Area can be used as work bits if the bits are not used as shown here.
	Link Area	3,200 (200 words): CIO 10000 to CIO 119915 (words CIO 1000 to CIO 1199) Link bits are used for data links and are allocated to Units in Controller Link Systems.	
	CPU Bus Unit Area	6,400 (400 words): CIO 150000 to CIO 189915 (words CIO 1500 to CIO 1899) CPU Bus Unit bits store the operating status of CPU Bus Units. (25 words per Unit, 16 Units max.)	
	Special I/O Unit Area	15,360 (960 words): CIO 200000 to CIO 295915 (words CIO 2000 to CIO 2959) Special I/O Unit bits are allocated to Special I/O Units. (10 words per Unit, 96 Units max.)	
	Serial PLC Link Area (CJ1M CPU Units only)	1,440 (90 words): CIO 310000 to CIO 318915 (words CIO 3100 to CIO 3189)	

Item		Specifications													
CIO (Core I/O) Area	DeviceNet Area	<p>9,600 (600 words): CIO 320000 to CIO 379915 (words CIO 3200 to CIO 3799) DeviceNet bits are allocated to Slaves for DeviceNet Unit remote I/O communications when the Master function is used with fixed allocations.</p> <table border="1"> <tr> <td>Fixed allocation setting 1</td> <td>Outputs: CIO 3200 to CIO 3263 Inputs: CIO 3300 to CIO 3363</td> </tr> <tr> <td>Fixed allocation setting 2</td> <td>Outputs: CIO 3400 to CIO 3463 Inputs: CIO 3500 to CIO 3563</td> </tr> <tr> <td>Fixed allocation setting 3</td> <td>Outputs: CIO 3600 to CIO 3663 Inputs: CIO 3700 to CIO 3763</td> </tr> </table> <p>The following words are allocated to the Master function even when the DeviceNet Unit is used as a Slave.</p> <table border="1"> <tr> <td>Fixed allocation setting 1</td> <td>Outputs: CIO 3370 (Slave to Master) Inputs: CIO 3270 (Master to Slave)</td> </tr> <tr> <td>Fixed allocation setting 2</td> <td>Outputs: CIO 3570 (Slave to Master) Inputs: CIO 3470 (Master to Slave)</td> </tr> <tr> <td>Fixed allocation setting 3</td> <td>Outputs: CIO 3770 (Slave to Master) Inputs: CIO 3670 (Master to Slave)</td> </tr> </table>	Fixed allocation setting 1	Outputs: CIO 3200 to CIO 3263 Inputs: CIO 3300 to CIO 3363	Fixed allocation setting 2	Outputs: CIO 3400 to CIO 3463 Inputs: CIO 3500 to CIO 3563	Fixed allocation setting 3	Outputs: CIO 3600 to CIO 3663 Inputs: CIO 3700 to CIO 3763	Fixed allocation setting 1	Outputs: CIO 3370 (Slave to Master) Inputs: CIO 3270 (Master to Slave)	Fixed allocation setting 2	Outputs: CIO 3570 (Slave to Master) Inputs: CIO 3470 (Master to Slave)	Fixed allocation setting 3	Outputs: CIO 3770 (Slave to Master) Inputs: CIO 3670 (Master to Slave)	The CIO Area can be used as work bits if the bits are not used as shown here.
	Fixed allocation setting 1	Outputs: CIO 3200 to CIO 3263 Inputs: CIO 3300 to CIO 3363													
Fixed allocation setting 2	Outputs: CIO 3400 to CIO 3463 Inputs: CIO 3500 to CIO 3563														
Fixed allocation setting 3	Outputs: CIO 3600 to CIO 3663 Inputs: CIO 3700 to CIO 3763														
Fixed allocation setting 1	Outputs: CIO 3370 (Slave to Master) Inputs: CIO 3270 (Master to Slave)														
Fixed allocation setting 2	Outputs: CIO 3570 (Slave to Master) Inputs: CIO 3470 (Master to Slave)														
Fixed allocation setting 3	Outputs: CIO 3770 (Slave to Master) Inputs: CIO 3670 (Master to Slave)														
Internal I/O Area	<p>4,800 (300 words): CIO 120000 to CIO 149915 (words CIO 1200 to CIO 1499) 37,504 (2,344 words): CIO 380000 to CIO 614315 (words CIO 3800 CIO 6143) These bits in the CIO Area are used as work bits in programming to control program execution. They cannot be used for external I/O.</p>														
Work Area		<p>8,192 bits (512 words): W00000 to W51115 (W000 to W511) Controls the programs only. (I/O from external I/O terminals is not possible.) Note: When using work bits in programming, use the bits in the Work Area first before using bits from other areas.</p>													
Holding Area		<p>8,192 bits (512 words): H00000 to H51115 (H000 to H511) Holding bits are used to control the execution of the program, and maintain their ON/OFF status when the PLC is turned OFF or the operating mode is changed. Note: The Function Block Holding Area words are allocated from H512 to H1535. These words can be used only for the function block instance area (internally allocated variable area).</p>													
Auxiliary Area		<p>Read only: 7,168 bits (448 words): A00000 to A44715 (words A000 to A447) Read/write: 8,192 bits (512 words): A44800 to A95915 (words A448 to A959) Auxiliary bits are allocated specific functions.</p>													
Temporary Area		<p>16 bits (TR0 to TR15) Temporary bits are used to temporarily store the ON/OFF execution conditions at program branches.</p>													
Timer Area		<p>4,096: T0000 to T4095 (used for timers only)</p>													
Counter Area		<p>4,096: C0000 to C4095 (used for counters only)</p>													
DM Area		<p>32 Kwords: D00000 to D32767 Used as a general-purpose data area for reading and writing data in word units (16 bits). Words in the DM Area maintain their status when the PLC is turned OFF or the operating mode is changed. Internal Special I/O Unit DM Area: D20000 to D29599 (100 words × 96 Units) Used to set parameters for Special I/O Units. CPU Bus Unit DM Area: D30000 to D31599 (100 words × 16 Units) Used to set parameters for CPU Bus Units.</p>													
Index Registers		<p>IR0 to IR15 Store PLC memory addresses for indirect addressing. Index registers can be used independently in each task. One register is 32 bits (2 words). • CJ1 CPU Units: Index registers used independently in each task.</p>													
Task Flag Area		<p>32 (TK0000 to TK0031) Task Flags are read-only flags that are ON when the corresponding cyclic task is executable and OFF when the corresponding task is not executable or in standby status.</p>													
Trace Memory		<p>4,000 words (trace data: 31 bits, 6 words)</p>													
File Memory		<ul style="list-style-type: none"> Memory Cards: Compact flash memory cards can be used (MS-DOS format). OMRON Memory Cards can be used. 													

■ Function Specifications

Item	Specifications	
Constant cycle time	1 to 32,000 ms (Unit: 1 ms)	
Cycle time monitoring	Possible (Unit stops operating if the cycle is too long): 10 to 40,000 ms (Unit: 10 ms)	
I/O refreshing	Cyclic refreshing, immediate refreshing, refreshing by IORF(097). Note: ORF(097) refreshes I/O bits allocated to Basic I/O Units and Special I/O Units. With the CJ1M CPU Units, the CPU BUS UNIT I/O REFRESH (DLNK(226)) instruction can be used to refresh bits allocated to CPU Bus Units in the CIO and DM Areas.	
Timing of special refreshing for CPU Bus Units	Data links for Controller Link Units and SYSMAC LINK Units, remote I/O for DeviceNet Units, and other special refreshing for CPU Bus Units is performed at the following times: • CJ1 and CJ1M CPU Units: I/O refresh period	
I/O memory holding when changing operating modes	Depends on the ON/OFF status of the IOM Hold Bit in the Auxiliary Area.	
Load OFF	All outputs on Output Units can be turned OFF when the CPU Unit is operating in RUN, MONITOR, or PROGRAM mode.	
Timer/Counter PV refresh method	CJ1M CPU Units: BCD or binary (CX-Programmer Ver. 3.0 or higher). CJ1 CPU Units: BCD only.	
Input response time setting	Time constants can be set for inputs from Basic I/O Units. The time constant can be increased to reduce the influence of noise and chattering or it can be decreased to detect shorter pulses on the inputs.	
Mode setting at power-up	Possible. Note: By default, the CPU Unit will start in RUN mode if a Programming Console is not connected.	
Flash memory	<ul style="list-style-type: none"> The user program and parameter area data (e.g., PLC Setup) are always backed up automatically in flash memory. (automatic backup and restore.) CPU Units with unit version 3.0 or later only: When downloading projects from CX-Programmer Ver. 5.0 or higher, symbol table files (including CX-Programmer symbol names, I/O comments), comment files (CX-Programmer rung comments, other comments), and program index files (CX-Programmer section names, section comments, or program comments) are stored in comment memory within the flash memory. 	
Memory Card functions	Automatically reading programs (autoboot) from the Memory Card when the power is turned ON.	Possible.
	Program replacement during PLC operation	Possible.
	Format in which data is stored in Memory Card	User program: Program file format PLC Setup and other parameters: Data file format I/O memory: Data file format (binary format), text format, or CSV format
	Functions for which Memory Card read/write is supported	User program instructions, Programming Devices (including CX-Programmer and Programming Consoles), Host Link computers, AR Area control bits, easy backup operation
Filing	Memory Card data and the EM (Extended Data Memory) Area can be handled as files.	
Debugging	Control set/reset, differential monitoring, data tracing (scheduled, each cycle, or when instruction is executed), instruction error tracing, storing location generating error when a program error occurs.	
Online editing	User programs can be overwritten in program-block units when the CPU Unit is in MONITOR or PROGRAM mode. This function is not available for block programming areas. With the CX-Programmer, more than one program block can be edited at the same time.	
Program protection	Overwrite protection: Set using DIP switch. Copy protection: Password set using CX-Programmer or Programming Consoles.	
Error check	User-defined errors (i.e., user can define fatal errors and non-fatal errors) The FPD(269) instruction can be used to check the execution time and logic of each programming block. Note: FAL and FALS instructions can be used with the CJ1M CPU Units to simulate errors.	
Error log	Up to 20 errors are stored in the error log. Information includes the error code, error details, and the time the error occurred. Note: A CJ1M CPU Unit can be set so that user-defined FAL errors are not stored in the error log.	
Serial communications	Built-in peripheral port: Programming Device (including Programming Console) connections, Host Links, NT Links, Serial Gateway (CompoWay/F master)	
	Built-in RS-232C port: Programming Device (excluding Programming Console) connections, Host Links, no-protocol communications, NT Links, Modbus-RTU Slave, Serial Gateway (CompoWay/F master or Modbus master)	
	Serial Communications Unit (sold separately): Protocol macros, Host Links, NT Links	
Clock	Provided on all models.	
	Accuracy:	Ambient temperature Monthly error
		55°C -3.5 min to +0.5 min
		25°C -1.5 min to +1.5 min
		0°C -3 min to +1 min
	Note: Used to store the time when power is turned ON and when errors occur.	
Power OFF detection time	AC Power Supply Unit: 10 to 25 ms (not fixed) DC Power Supply Unit PD025: 2 to 5 ms; PD022: 2 to 10 ms	
Power OFF detection delay time	0 to 10 ms (user-defined, default: 0 ms) Note: Not supported when the CJ1W-PD022 Power Supply Unit is mounted.	
Memory protection	Held Areas: Holding bits, contents of Data Memory and Extended Data Memory, and status of the counter Completion Flags and present values. Note: If the IOM Hold Bit in the Auxiliary Area is turned ON, and the PLC Setup is set to maintain the IOM Hold Bit status when power to the PLC is turned ON, the contents of the CIO Area, the Work Area, part of the Auxiliary Area, timer Completion Flag and PVs, Index Registers, and the Data Registers will be saved for up to 20 days.	
Sending commands to a Host Link computer	FINS commands can be sent to a computer connected via the Host Link System by executing Network Communications Instructions from the PLC.	
Remote programming and monitoring	Host Link communications can be used for remote programming and remote monitoring through a Controller Link System or Ethernet network.	

Item	Specifications
Communicating across network levels	Remote programming and monitoring from Support Software and FINS message communications can be performed across different network levels, even for different types of network. Pre-Ver. 2.0: Three levels Version 2.0 or later: Eight levels for Controller Link and Ethernet networks (See note.), three levels for other networks. Note: To communicate across eight levels, the CX-Integrator or the CX-Net in Programmer version 4.0 or higher must be used to set the routing tables.
Storing comments in CPU Unit	I/O comments can be stored as symbol table files in the Memory Card, EM file memory, or comment memory (see note). Note: Comment memory is supported for CX-Programmer version 5.0 or higher and CS/CJ-series CPU Units with unit version 3.0 or later only.
Program check	Program checks are performed at the beginning of operation for items such as no END instruction and instruction errors. CX-Programmer can also be used to check programs.
Control output signals	RUN output: The internal contacts will turn ON (close) while the CPU Unit is operating (CJ1W-PA205R).
Battery life	<ul style="list-style-type: none"> • Battery Set for CJ1 CPU Units: CPM2A-BAT01 • Battery Set for CJ1M CPU Units: CJ1W-BAT01
Self-diagnostics	CPU errors (watchdog timer), I/O bus errors, memory errors, and battery errors.
Other functions	Storage of number of times power has been interrupted. (Stored in A514.)

● **Functions Added for New Unit Versions**

Refer to the SYSMAC CJ-series CJ1 CPU Units Datasheet.

● **Relations between CX-Programmer Versions and Unit Versions of CPU Units**

Refer to the SYSMAC CJ-series CJ1 CPU Units Datasheet.

CJ1M-CPU2□ (CJ1M CPU with Built-in I/O) Specifications

- CJ1M-CPU2□ CPU Units have 10 built-in inputs and 6 built-in outputs.
- The 10 inputs can be used as general-purpose inputs, interrupt inputs, quick-response inputs, high-speed counters, or origin search origin input signals.
- The 6 outputs can be used as general-purpose outputs, pulse outputs, or origin search deviation counter reset outputs.

■ Data Area Allocations for Built-in I/O

I/O Code		IN 0	IN 1	IN 2	IN 3	IN 4	IN 5	IN 6	IN 7	IN 8	IN 9	OUT 0	OUT 1	OUT 2	OUT 3	OUT 4	OUT 5
Address		2960										2961					
Bit		0	1	2	3	4	5	6	7	8	9	0	1	2	3	4	5
Inputs	General purpose inputs	General purpose input 0	General purpose input 1	General purpose input 2	General purpose input 3	General purpose input 4	General purpose input 5	General purpose input 6	General purpose input 7	General purpose input 8	General purpose input 9	---	---	---	---	---	---
	Interrupt inputs	Interrupt input 0	Interrupt input 1	Interrupt input 2	Interrupt input 3	---	---	---	---	---	---	---	---	---	---	---	---
	Quick response inputs	Quick response input 0	Quick response input 1	Quick response input 2	Quick response input 3	---	---	---	---	---	---	---	---	---	---	---	---
	High-speed counters	---	---	High-speed counter 1 (phase-Z/reset)	High-speed counter 0 (phase-Z/reset)	---	---	High-speed counter 1 (phase-A, increment, or count input)	High-speed counter 1 (phase-B, decrement, or direction input)	High-speed counter 0 (phase-A, increment, or count input)	High-speed counter 0 (phase-B, decrement, or direction input)	---	---	---	---	---	---
Out-puts	General-purpose outputs	---	---	---	---	---	---	---	---	---	---	General-purpose output 0	General-purpose output 1	General-purpose output 2	General-purpose output 3	General-purpose output 4	General-purpose output 5
	Pulse out-puts	CW/CCW outputs	---	---	---	---	---	---	---	---	---	Pulse output 0 (CW)	Pulse output 0 (CCW)	Pulse output 1 (CW)	Pulse output 1 (CCW)	---	---
		Pulse + direction outputs	---	---	---	---	---	---	---	---	---	Pulse output 0 (pulse)	Pulse output 1 (pulse)	Pulse output 0 (direction)	Pulse output 1 (direction)	---	---
		Variable duty ratio outputs	---	---	---	---	---	---	---	---	---	---	---	---	---	---	PWM(8 91) output 0
Origin search	Origin search 0 (Origin Input Signal)	Origin search 0 (Origin Proximity Input Signal)	Origin search 1 (Origin Input Signal)	Origin search 1 (Origin Proximity Input Signal)	Origin search 0 (Positioning Completed Signal)	Origin search 1 (Positioning Completed Signal)	---	---	---	---	---	---	---	---	---	Origin search 0 (Error Counter Reset Output)	Origin search 1 (Error Counter Reset Output)

Note: CJ1M-CPU21 CPU Units have one PWM output only and do not have PWM output 1.

■ Built-in Input Specifications

● Interrupt Inputs and Quick-response Inputs

Item	Specifications
No. of interrupt inputs/quick-response inputs	4 total
Input inter-rupts	Direct (Input Interrupt) Mode Execution of an interrupt task is started at the interrupt input's rising or falling edge. Interrupt numbers 140 to 143 are used (fixed). Response time from meeting input condition to start of interrupt task execution: 93 μs min.
	High-speed Counter Mode Rising or falling edges of the interrupt are counted using either an incrementing or decrementing counter, and an interrupt task is started when the input count reaches the set value. Interrupt numbers 140 to 143 are used (fixed). I/O response frequency: 1 kHz
Quick-response inputs	Signals that are shorter than the cycle time (30 μs min.) can be read and treated the same as signals that are one for more than one cycle time.

● High-speed Counter Inputs

Item	Specifications
Number of high-speed counters	2 (High-speed counters 0 and 1)
Pulse input mode (Selected in PLC Setup)	Differential phase inputs (phase-A, phase-B, and phase-Z input) Up/down inputs (up inputs, down inputs, reset inputs) Pulse + direction inputs (pulse inputs, direction inputs, reset inputs) Increment inputs (increment inputs, reset inputs)
Re-sponse frequency	Line-driver inputs 50 kHz 100 kHz 100 kHz 100 kHz
	24-V DC inputs 30 kHz 60 kHz 60 kHz 60 kHz
Counting mode	Linear mode or Ring mode (Select in the PLC Setup.)

Item		Specifications
Count value		Linear mode: 80000000 to 7FFFFFFF hex Ring mode: 00000000 to Ring SV (The Ring SV is set in the PLC Setup and the setting range is 00000001 to FFFFFFFF hex.)
High-speed counter PV storage locations		High-speed counter 0: A271 (leftmost 4 digits) and A270 (rightmost 4 digits) High-speed counter 1: A273 (leftmost 4 digits) and A272 (rightmost 4 digits) Target value comparison interrupts or range comparison interrupts can be executed based on these PVs. Note: The PVs are refreshed in the overseeing processes at the beginning of each cycle. Use the PRV(881) instruction to read the most recent PVs.
Control method	Target value comparison	Up to 48 target values and corresponding interrupt task numbers can be registered.
	Range comparison	Up to 8 ranges can be registered, with an upper limit, lower limit, and interrupt task number for each.
Counter reset method		Phase-Z + Software reset: Counter is reset when phase-Z input goes ON while Reset Bit is ON. Software reset: Counter is reset when Reset Bit goes ON. Reset Bits: High-speed Counter 0 Reset Bit is A53100, Counter 1 Reset Bit is A53101.

■ Built-in Output Specifications

● Position Control and Speed Control

Item		Specifications
Number of pulse outputs		2 (Pulse output 0 or 1)
Output frequency		1 Hz to 100 kHz (1-Hz units from 1 to 100 Hz, 10-Hz units from 100 Hz to 4 kHz, and 100-Hz units from 4 to 100 kHz)
Frequency acceleration and deceleration rates		Set in 1 Hz units for acceleration/deceleration rates from 1 Hz to 2 kHz (every 4 ms). The acceleration and deceleration rates can be set separately only with PLS2(887).
Changing SVs during instruction execution		The target frequency, acceleration/deceleration rate, and target position can be changed. Changes to the target frequency and acceleration/deceleration rate must be made at constant speed.
Pulse output method		CW/CCW inputs or Pulse + direction inputs
Number of output pulses		Relative coordinates: 00000000 to 7FFFFFFF hex (Each direction accelerating or decelerating: 2,147,483,647) Absolute coordinates: 80000000 to 7FFFFFFF hex (-2,147,483,648 to 2,147,483,647)
Instruction used for origin searches and returns		ORIGIN SEARCH (ORG(889)): Origin search and origin return operations according to set parameters
Instructions used for position and speed control		PULSE OUTPUT (PLS2(887)): Trapezoidal output control with separate acceleration and deceleration rate SET PULSES (PULS(886)): Setting the number of pulses for pulse output SPEED OUTPUT (SPED(885)): Pulse output without acceleration or deceleration (Number of pulses must be set in advance with PULS(886) for position control.) ACCELERATION CONTROL (ACC(888)): Changes frequency or pulse output with acceleration and deceleration MODE CONTROL (INI(880)): Stopping pulse output
Pulse output PV's storage location		The following Auxiliary Area words contain the pulse output PVs: Pulse output 0: A277 (leftmost 4 digits) and A276 (rightmost 4 digits) Pulse output 1: A279 (leftmost 4 digits) and A278 (rightmost 4 digits) The PVs are refreshed during regular I/O refreshing. PVs can be read to user-specified words with the PRV(881) instruction.

● Variable-duty Pulse Outputs (PWM)

Item		Specifications
Number of PWM outputs		CJ1M-CPU22/23: 2 (PWM output 0 or 1) CJ1M-CPU21: 1 (PWM output 0)
Duty ratio		0% to 100%, set in 0.1% units (See note.)
Frequency		0.1 Hz to 999.9 Hz, Set in 0.1 Hz units.
Instruction		PULSE WITH VARIABLE DUTY RATIO (PWM(891)): Sets duty ratio and outputs pulses.

Note: CJ1M CPU Unit Ver. 2.0 or later only. (0% to 100%, set in 1% units for Pre-Ver. 2.0 CPU Units.)

■ Hardware Specifications
● Input Specifications

Item		Specifications			
Number of inputs		10 inputs			
Input method		24-V DC inputs or line driver (wiring changed to select)			
Input voltage specifications		24 V DC		Line driver	
		IN0 to IN5	IN6 to IN9	IN0 to IN5	IN6 to IN9
Input voltage		20.4 to 26.4 V DCV			
Input impedance		3.6 kΩ	4.0 kΩ	---	
Input current (typical)		6.2 mA	4.1 mA	13 mA	10 mA
Minimum ON voltage		17.4 V DC/3 mA min.			
Maximum OFF voltage		5.0 V DC/1 mA max.			
Response speed (for general-purpose inputs)	ON response time	Default setting: 8 ms max. (The input time constant can be set to 0 ms, 0.5 ms, 1 ms, 2 ms, 4 ms, 8 ms, 16 ms, or 32 ms in the PLC Setup.)			
	OFF response time	Default setting: 8 ms max. (The input time constant can be set to 0 ms, 0.5 ms, 1 ms, 2 ms, 4 ms, 8 ms, 16 ms, or 32 ms in the PLC Setup.)			

● Input Circuit Configuration

Item		Specifications	
Input		IN0 to IN5	IN6 to IN9
Circuit configuration			

● General-purpose Output Specifications for Transistor Outputs (Sinking)

Item		Specifications	
Output		OUT0 to OUT3	OUT4 to OUT5
Rated voltage		5 to 24 V DC	
Allowable voltage range		4.75 to 26.4 V DC	
Max. switching capacity		0.3 A/output; 1.8 A/Unit	
Number of circuits		6 outputs (6 outputs/common)	
Max. inrush current		3.0 A/output, 10 ms max.	
Leakage current		0.1 mA max.	
Residual voltage		0.6 V max.	
ON delay		0.1 mA max.	
OFF delay		0.1 mA max.	
Fuse		None	
External power supply		10.2 to 26.4 V DC 50 mA min.	
Circuit configuration			

● Pulse Output Specifications (OUT0 to OUT3)

Item		Specifications	
Max. switching capacity		30 mA, 4.75 to 26.4 V DC	
Min. switching capacity		7 mA, 4.75 to 26.4 V DC	
Max. output frequency		100 kHz	
Output waveform			

CJ1M-CPU1□-ETN (CJ1M CPU with Ethernet Function) Specifications

These CPU Units provide built-in Ethernet functionality.

● Ethernet Functional Element Transfer Specifications

Item		Specification
Media access method		CSMA/CD
Modulation method		Baseband
Transmission paths		Star form
Baud rate		100 Mbit/s (100Base-TX), 10 Mbit/s (10Base-T)
Transmission media	100 Mbit/s	Unshielded twisted-pair (UDP) cable Categories: 5, 5e Shielded twisted-pair (STP) cable Categories: 100 Ω at 5, 5e
	10 Mbit/s	Unshielded twisted-pair (UDP) cable Categories: 3, 4, 5, 5e Shielded twisted-pair (STP) cable Categories: 100 Ω at 3, 4, 5, 5e
Transmission distance		100 m (distance between hub and node)
Number of cascade connections		There are no restrictions with the use of switching hubs.
CPU Bus Unit System Setup Area capacity		994 bytes (See note 2.)

Note: The system settings for Ethernet are in the CPU Bus Unit System Setup Area in the CPU Unit.

CJ1G-CPU□□P (Loop-control CPU Units) Specifications

In addition to engines for executing sequence control, Loop-control CPU Units (CJ1G-CPU□□P) have built-in engines for controlling analog quantities (such as temperatures, pressure and flow rate), thus enabling high-speed sequence control and advanced high-speed control of analog quantities in a single Unit.

● CPU Element (Sequence Control)

Name	I/O bits	Program capacity	DM words	EM words	Model
Loop-control CPU Unit	1,280 bits	60K steps	32K words	32K words × 3 banks E0_00000 to E2_32767	CJ1G-CPU45P
		30K steps			CJ1G-CPU45P-GTC (See note.)
	960 bits	20K steps		32K words × 1 bank E0_00000 to E0_32767	CJ1G-CPU44P
		10K steps			CJ1G-CPU43P
					CJ1G-CPU42P

Note: These Loop-control CPU Units support gradient temperature control, a technology for uniform in-plane control of temperatures of plane-shaped objects (e.g., multi-point control of surface temperatures based on a multi-point heater). For details, please contact an OMRON representative.

● Loop Controller Element (Loop Control)

Item	Model	CJ1G-CPU42P	CJ1G-CPU43P	CJ1G-CPU44P	CJ1G-CPU45P(-GTC)	
Operation method		Function block method				
Operation cycle		0.01, 0.02, 0.05, 0.1, 0.2, 0.5, 1, or 2 s (default: 1 s) Can be set for each function block.				
Number of function blocks	Analog operations	Control and operation blocks	50 blocks max.	300 blocks max.		
	Sequence control	Step ladder program blocks	20 blocks max. 2,000 commands total	200 blocks max. 4,000 commands total		
	I/O blocks	Field terminal blocks	30 blocks max.	40 blocks max.		
		User link tables	2,400 data items max.			
		Batch allocation	HMI function, allocated 1 EM Area bank			
System Common block		Single block				
Method for creating and transferring function blocks		Created using CX-Process Tool (order separately) and transferred to Loop Controller.				
Control method	PID control method		PID with 2 degrees of freedom (with autotuning)			
	Control combinations		Any of the following function blocks can be combined: Basic PID control, cascade control, feed-forward control, sample PI control, Smith dead time compensation control, PID control with differential gap, override control, program control, time-proportional control, etc.			
Alarms	PID block internal alarms		4 PV alarms (upper upper-limit, upper limit, lower limit, lower lower-limit) and 1 deviation alarm per PID block.			
	Alarm blocks		High/low alarm blocks, deviation alarm blocks			

Checking Current Consumption and Power Consumption

After selecting a Power Supply Unit based on considerations such as the power supply voltage, calculate the current and power requirements for each Rack.

Condition 1: Current Requirements

There are two voltage groups for internal power consumption: 5 V and 24 V.

Current consumption at 5 V (internal logic power supply)

Current consumption at 24 V (relay driving power supply)

Condition 2: Power Requirements

For each Rack, the upper limits are determined for the current and power that can be provided to the mounted Units. Design the system so that the total current consumption for all the mounted Units does not exceed the maximum total power or the maximum current supplied for the voltage groups shown in the following tables.

The maximum current and total power supplied for CPU Racks and Expansion Racks according to the Power Supply Unit model are shown below.

Note 1. For CPU Racks, include the CPU Unit current and power consumption in the calculations. When expanding, also include the current and power consumption of the I/O Control Unit in the calculations.

2. For Expansion Racks, include the I/O Interface Unit current and power consumption in the calculations.

Power Supply Units	Max. current supplied		Max. total power supplied
	5 V	24 V (relay driving current)	
CJ1W-PA205C	5.0 A	0.8 A	25 W
CJ1W-PA205R	5.0 A	0.8 A	25 W
CJ1W-PA202	2.8 A	0.4 A	14 W
CJ1W-PD025	5.0 A	0.8 A	25 W
CJ1W-PD022	2.0 A	0.4 A	19.6 W

Conditions 1 and 2 below must be satisfied.

Condition 1: Maximum Current

(1) Total Unit current consumption at 5 V ≤ (A) value

(2) Total Unit current consumption at 24 V ≤ (B) value

Condition 2: Maximum Power

(1) × 5 V + (2) × 24 V ≤ (C) value

Example: Calculating Total Current and Power Consumption

Example: When the Following Units are Mounted to a CJ-series CPU Rack Using a CJ1W-PA202 Power Supply Unit

Unit type	Model	Quantity	Voltage group	
			5 V	24 V
CPU Unit	CJ1M-CPU13	1	0.580 A	---
I/O Control Unit	CJ1W-IC101	1	0.020 A	---
Basic I/O Units (Input Units)	CJ1W-ID211	2	0.080 A	---
	CJ1W-ID231	2	0.090 A	---
Basic I/O Units (Output Units)	CJ1W-OC201	2	0.090 A	0.048 A
Special I/O Unit	CJ1W-DA041	1	0.120 A	---
CPU Bus Unit	CJ1W-CLK23	1	0.350 A	---
Current consumption	Total		$0.580 + 0.020 + 0.080 \times 2 + 0.090 \times 2 + 0.090 \times 2 + 0.120 + 0.350$	$0.048 \text{ A} \times 2$
	Result		1.59 A (≤ 2.8 A)	0.096 A (≤ 0.4 A)
Power consumption	Total		$1.59 \times 5 \text{ V} = 7.95 \text{ W}$	$0.096 \text{ A} \times 24 \text{ V} = 2.304 \text{ W}$
	Result		$7.95 + 2.304 = 10.254 \text{ W} (\leq 14 \text{ W})$	

Note: For details on Unit current consumption, refer to *Ordering Information*.

Using the CX-Programmer to Display Current Consumption and Width

CPU Rack and Expansion Rack current consumption and width can be displayed by selecting Current Consumption and Width from the Options Menu in the CS/CJ/CP Table Window. (The width can be displayed for the CJ/CP Series only.) If the capacity of the Power Supply Unit is exceeded, it will be displayed in red characters. For details, refer to the *CX-Programmer Operation Manual* (Cat. No. W446).

Example:

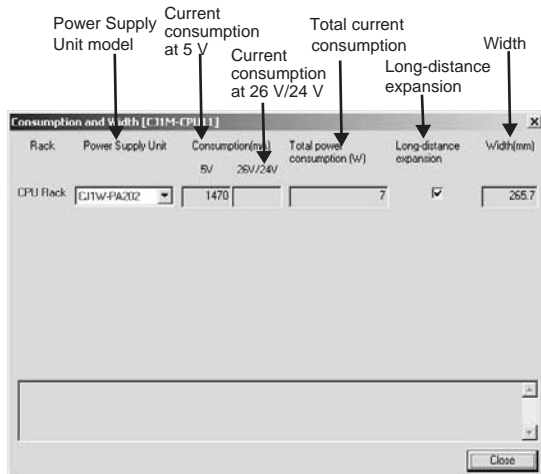

MEMO

A large grid of dashed lines for writing a memo. The grid consists of 14 columns and 20 rows of squares. The lines are evenly spaced and cover most of the page area below the header.

Ordering Information

Basic Configuration Units	26
Programming Devices	31
Optional Products and Maintenance Products	34
DIN Track Accessories	34
Basic I/O Units	35
Special I/O Units and CPU Bus Units	39

International Standards

- The standards are abbreviated as follows: U: UL, U1: UL (Class I Division 2 Products for Hazardous Locations), C: CSA, UC: cULus, UC1: cULus (Class I Division 2 Products for Hazardous Locations), CU: cUL, N: NK, L: Lloyd, and CE: EC Directives.
- Contact your OMRON representative for further details and applicable conditions for these standards.
- Low Voltage Directive
Applicable Standard: EN61131-2
VDC must satisfy the appropriate safety requirements. With PLCs, this applies to Power Supply Units and I/O Units that operate in these voltage ranges. These Units have been designed to conform to EN61131-2, which is the applicable standard for PLCs.

● EC Directives

The EC Directives applicable to PLCs include the EMC Directives and the Low Voltage Directive. OMRON complies with these directives as described below.

● EMC Directives

Applicable Standards

EMI: EN61000-6-4, EN61131-2

EMS: EN61000-6-2, EN61131-2

PLCs are electrical devices that are incorporated in machines and manufacturing installations. OMRON PLCs conform to the related EMC standards so that the devices and machines into which they are built can more easily conform to EMC standards. The actual PLCs have been checked for conformity to EMC standards. Whether these

standards are satisfied for the actual system, however, must be checked by the customer.

EMC-related performance will vary depending on the configuration, wiring, and other conditions of the equipment or control panel in which the PLC is installed. The customer must, therefore, perform final checks to confirm that the overall machine or device conforms to EMC standards.

Ordering Information

Basic Configuration Units

CPU Units

■ CJ1 CPU Units

Product name	Specifications				Current consumption (A)		Model	Standards
	I/O capacity/ Mountable Units (Expansion Racks)	Program capacity	Data memory capacity	LD instruction execution time	5 V	24 V		
CJ1M CPU Units 	640 points/ 20 Units (1 Expansion Racks max.)	20K steps	32 K words (DM: 32K words, EM: None)	0.1 μs	0.58 (See note 1.)	---	CJ1M-CPU13	UC1, N, L, CE
	320 points/ 10 Units (No Expansion Rack)	10K steps			0.58 (See note 1.)	---	CJ1M-CPU12	
	160 points/ 10 Units (No Expansion Rack)	5K steps			0.58(See note 1.)	---	CJ1M-CPU11 (See note 2.)	

Note 1. Current consumptions include current for a Programming Console. Add 0.15 A per Adapter when using NT-AL001 RS-232C/RS-232A Adapters. Add 0.04 A per Adapter when using CJ1W-CIF11 RS-422A Adapters.

2. The CJ1M low-end models (CJ1M-CPU11(-ETN)/CPU21) have different specifications for the overhead processing time, pulse start time, number of subroutines, number of jumps, number of scheduled interrupts, and number of PWM outputs than the other CJ1M models (CJ1M-CPU12(-ETN)/CPU13(-ETN)/CPU22/CPU23).

For details, refer to the SYSMAC CJ-series Operation Manual (Cat. No. W474) and the SYSMAC CJ-series Built-in I/O Operation Manual (Cat. No. W395).

■ CJ1M CPU Units (with Built-in I/O)

Product name	Specifications					Current consumption (A)		Model	Standards
	I/O capacity/ Mountable Units (Expansion Racks)	Program capacity	Data memory capacity	LD instruction execution time	Built-in I/O	5 V	24 V		
CJ1M CPU Units 	640 points/ 20 Units (1 Expansion Racks max.)	20K steps	32K words (DM: 32K words, EM: None)	0.1 μs	10 inputs and 6 outputs, 2 counter inputs, 2 pulse outputs	0.64 (See note 1.)	---	CJ1M-CPU23 (See note 3.)	UC1, N, L, CE
	320 points/ 10 Units (No Expansion Rack)	10K steps				0.64 (See note 1.)	---	CJ1M-CPU22 (See note 3.)	
	160 points/ 10 Units (No Expansion Rack)	5K steps				0.64 (See note 1.)	---	CJ1M-CPU21 (See notes 2 and 3.)	

Note 1. Current consumptions include current for a Programming Console. Add 0.15 A per Adapter when using NT-AL001 RS-232C/RS-232A Adapters. Add 0.04 A per Adapter when using CJ1W-CIF11 RS-422A Adapters.

2. The CJ1M low-end models (CJ1M-CPU11(-ETN)/CPU21) have different specifications for the overhead processing time, pulse start time, number of subroutines, number of jumps, number of scheduled interrupts, and number of PWM outputs than the other CJ1M models (CJ1M-CPU12(-ETN)/CPU13(-ETN)/CPU22/CPU23).

For details, refer to the SYSMAC CJ-series Operation Manual (Cat. No. W474) and the SYSMAC CJ-series Built-in I/O Operation Manual (Cat. No. W395).

3. The connector for built-in I/O in the CJ1M-CPU21/22/23 is not included. Purchase one of the connectors or connector cables, refer to connectors or connector cables on page 28.

■ CJ1M CPU Units (with Ethernet function)

Product name		Specifications					Current consumption (A)		Model	Standards
		I/O capacity/ Mountable Units (Expansion Racks)	Program capacity	Data memory capacity	LD instruction execution time	Ethernet function	5 V	24 V		
CJ1M CPU Units	 Ethernet function	640 points/ 20 Units (1 Expansion Racks max.)	20K steps	32K words (DM: 32K words, EM: None)	0.1 μs	YES (See note 1.)	0.95 (See note 2.)	---	CJ1M-CPU13-ETN	UC1, N, L, CE
		320 points/ 10 Units (No Expansion Rack)	10K steps				0.95 (See note 2.)	---	CJ1M-CPU12-ETN	
		160 points/ 10 Units (No Expansion Rack)	5K steps				0.95 (See note 2.)	---	CJ1M-CPU11-ETN (See notes 3.)	

Note 1. Ethernet function

The Ethernet functional element provides the main functions of the CJ1W-ETN21 Ethernet Unit.

Physical layer	Maximum number of nodes in FINS network	Communications service
100BASE-TX, 10BASE-T	254	<ul style="list-style-type: none"> • FINS communications service • FTP server • Automatically adjusted clock information. • Web functions

Socket services and sending/receiving mail are not supported.

2. Current consumptions include current for a Programming Console. Add 0.15 A per Adapter when using NT-AL001 RS-232C/RS-232A Adapters. Add 0.04 A per Adapter when using CJ1W-CIF11 RS-422A Adapters.

3. The CJ1M low-end models (CJ1M-CPU11(-ETN)/CPU21) have different specifications for the overhead processing time, number of subroutines, number of jumps, and number of scheduled interrupts than the other CJ1M models (CJ1M-CPU12(-ETN)/CPU13(-ETN)/CPU22/CPU23).

For details, refer to the SYSMAC CJ-series Operation Manual (Cat. No. W474).

■ CJ1G Loop-control CPU Units

Product name		Specifications					Current consumption (A)		Model	Standards
		CPU Unit				Loop Controller	5 V	24 V		
I/O capacity/ Mountable Units (Expansion Racks)	Program capacity	Data memory capacity	LD instruction execution time							
CJ1G Loop-control CPU Units		1,280 points/ 40 Units (3 Expansion Racks max.)	60K steps	128K words (DM: 32K words, EM: 32K words × 3 banks)	0.04 μs	Number of function blocks: 300 blocks max.	1.06 (See note.)	---	CJ1G-CPU45P	UC1, CE
			30K steps				1.06 (See note.)	---	CJ1G-CPU45P-GTC	
		960 points/ 30 Units (2 Expansion Racks max.)	20K steps	64K words (DM: 32K words, EM: 32K words × 1 bank)			1.06 (See note.)	---	CJ1G-CPU44P	
			10K steps				1.06 (See note.)	---	CJ1G-CPU43P	
					Number of function blocks: 50 blocks max.	1.06 (See note.)	---	CJ1G-CPU42P		

Note: Current consumptions include current for a Programming Console. Add 0.15 A per Adapter when using NT-AL001 RS-232C/RS-232A Adapters. Add 0.04 A per Adapter when using CJ1W-CIF11 RS-422A Adapters.

● Connector Cables for Built-in I/O in CJ1M-CPU2□ CPU Units

The connector for built-in I/O in the CJ1M-CPU21/22/23 is not included.

Purchase one of the connectors or connector cables in the following table separately.

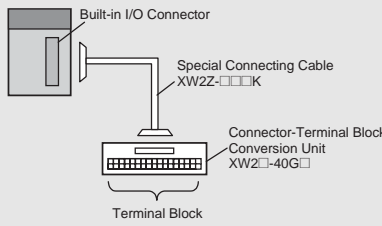
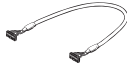
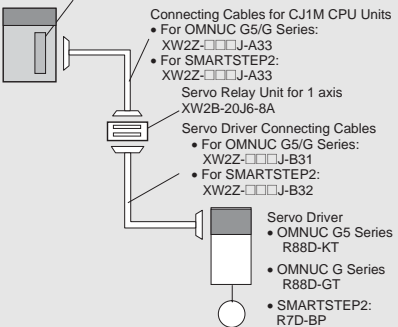
Product name		Specifications		Model	Standards	
Applicable Connector 		MIL Flat Cable Connectors (Pressure-fitted Connectors)		XG4M-4030-T	---	
Normal Connection Method for Built-in I/O (When Connector-Terminal Block Conversion Unit is Used) CJ1M-CPU2□ (with Built-in I/O) 	Connector-Terminal Block Conversion Units	Slim type (M3 screw terminals, 40-pin)		XW2D-40G6	---	
		Through type (M3 screw terminals, 40-pin)		XW2B-40G4		
		Through type (M3.5 screw terminals, 40-pin)		XW2B-40G5		
	Connecting Cable for Connector-Terminal Block Conversion Units			Cable length: 1 m	XW2Z-100K	
		Cable length: 1.5 m		XW2Z-150K		
		Cable length: 2 m		XW2Z-200K		
		Cable length: 3 m		XW2Z-300K		
		Cable length: 5 m		XW2Z-500K		
Connection to Servo Driver with Built-in I/O CJ1M-CPU2□ (with Built-in I/O)  <p>When two axes are used, two Connecting Cables are required at the Servo Driver for each Servo Relay Unit.</p>	Servo Relay Units	For 1 axis		XW2B-20J6-8A	---	
		For 2 axes		XW2B-40J6-9A		
	Connecting Cable for Servo Relay Units		G5/G Series	Cable for CJ1M CPU Unit	Cable length: 0.5 m	XW2Z-050J-A33
					Cable length: 1 m	XW2Z-100J-A33
			Servo Driver Connecting Cables	Cable length: 1 m	XW2Z-100J-B31	
				Cable length: 2 m	XW2Z-200J-B31	
			SMARTSTEP2	Cable for CJ1M CPU Unit	Cable length: 0.5 m	XW2Z-050J-A33
					Cable length: 1 m	XW2Z-100J-A33
	Servo Driver Connecting Cables	Cable length: 1 m		XW2Z-100J-B32		
		Cable length: 2 m		XW2Z-200J-B32		

■ Power Supply Units

One Power Supply Unit is required for each Rack.

Product name	Power supply voltage	Output capacity			Options			Model	Standards
		5-VDC output capacity	24-VDC output capacity	Total power consumption	24-VDC service power supply	RUN output	Maintenance forecast monitor		
 AC Power Supply Unit	100 to 240 VAC	5 A	0.8 A	25 W	No	No	Yes	CJ1W-PA205C	UC1, N, L, CE
						Yes	No	CJ1W-PA205R	
		2.8 A	0.4 A	14 W		No	No	No	
 DC Power Supply Unit	24 VDC	5A	0.8 A	25 W	No	No	No	CJ1W-PD025	UC1, CE
		2 A	0.4 A	19.6 W		No	No	CJ1W-PD022	

Expansion Racks

Select the I/O Control Unit, I/O Interface Unit, Expansion Connecting Cable, and CJ-series Power Supply Unit.

■ CJ-series I/O Control Unit (Mounted on CPU Rack when Connecting Expansion Racks)

Product name	Specifications	Current consumption (A)		Model	Standards
		5 V	24 V		
 CJ-series I/O Control Unit	Mount one I/O Control Unit on the CJ-series CPU Rack when connecting one or more CJ-series Expansion Racks. Connecting Cable: CS1W-CN□□3 Expansion Connecting Cable Connected Unit: CJ1W-II101 I/O Interface Unit Mount to the right of the CPU Unit.	0.02	---	CJ1W-IC101	UC1, N, L, CE

Note: Mounting the I/O Control Unit in any other location may cause faulty operation.

■ CJ-series I/O Interface Unit (Mounted on Expansion Rack)

Product Name	Specifications	Current consumption (A)		Model	Standards
		5 V	24 V		
 CJ-series I/O Interface Unit	One I/O Interface Unit is required on each Expansion Rack. Connecting Cable: CS1W-CN□□3 Expansion Connecting Cable Mount to the right of the Power Supply Unit.	0.13	---	CJ1W-II101	UC1, N, L, CE

Note: Mounting the I/O Interface Unit in any other location may cause faulty operation.

■ I/O Connecting Cables

Product name	Specifications		Model	Standards
<p>I/O Connecting Cable</p> 	<ul style="list-style-type: none"> • Connects an I/O Control Unit on CJ-series CPU Rack to an I/O Interface Unit on a CJ-series Expansion Rack. or • Connects an I/O Interface Unit on CJ-series Expansion Rack to an I/O Interface Unit on another CJ-series Expansion Rack. 	Cable length: 0.3 m	CS1W-CN313	N, L, CE
		Cable length: 0.7 m	CS1W-CN713	
		Cable length: 2 m	CS1W-CN223	
		Cable length: 3 m	CS1W-CN323	
		Cable length: 5 m	CS1W-CN523	
		Cable length: 10 m	CS1W-CN133	
		Cable length: 12 m	CS1W-CN133-B2	

Programming Devices

Support Software

Product name	Specifications	Number of licenses	Media	Model	Standards
FA Integrated Tool Package CX-One Ver. 4.□	The CX-One is a comprehensive software package that integrates Support Software for OMRON PLCs and components. CX-One runs on the following OS. Windows XP (Service Pack 3 or higher), Vista, or 7 Note: Except for Windows XP 64-bit version. CX-One Version 4.□ includes CX-Programmer Ver.9.□ and CX-Simulator Ver. 1.□. For details, refer to the CX-One catalog (Cat. No. R134).	1 license	DVD	CXONE-AL01D-V4	---
		3 licenses		CXONE-AL03D-V4	
		10 licenses		CXONE-AL10D-V4	
		30 licenses		CXONE-AL30D-V4	
		50 licenses		CXONE-AL50D-V4	

Note: The CX-One is also available on CD (CXONE-AL□□C-V4).

Site licenses are available for users who will run CX-One on multiple computers. Ask your OMRON sales representative for details.





Support Software in CX-One Version 4.□

The following tables lists the Support Software that can be installed from CX-One

Support Software in CX-One	Outline
CX-Programmer Ver.9.□	Application software to create and debug programs for SYSMAC CS/CJ/CP/NSJ-series, C-series, and CVM1/C-series CPU Units. Data can be created and monitored for high-speed-type Position Control Units and Position Control Units with EtherCAT interface.
CX-Integrator Ver.2.□	Application software to build and set up FA networks, such as Controller Link, DeviceNet, CompoNet, CompoWay, and Ethernet networks. The Routing Table Component and Data Link Component can be started from here. DeviceNet Configuration functionality is also included.
Switch Box Utility Ver.1.□	Utility software that helps you to debug PLCs. It helps you to monitor the I/O status and to monitor/change present values within the PLC you specify.
CX-Protocol Ver.1.□	Application software to create protocols (communications sequences) between SYSMAC CS/CJ/CP/NSJ-series or C200HX/HG/HE Serial Communications Boards/Units and general-purpose external devices.
CX-Simulator Ver.1.□	Application software to simulate SYSMAC CS/CJ/CP/NSJ-series CPU Unit operation on the computer to debug PLC programs without a CPU Unit.
CX-Position Ver.2.□	Application software to create and monitor data for SYSMAC CS/CJ-series Position Control Units (except for high-speed type).
CX-Motion-NCF Ver.1.□	Application software to create and monitor data for SYSMAC CS/CJ-series Position Control Units with MECHATROLINK-II interface (MC□71).
CX-Motion-MCH Ver.2.□	Application software to create data and motion programs and to monitor data for SYSMAC CS/CJ-series Motion Control Units with MECHATROLINK-II interface (MCH71).
CX-Motion Ver.2.□	Application software to create data for SYSMAC CS/CJ-series, C200HX/HG/HE, and CVM1/CV-series Motion Control Units, and to create and monitor motion control programs.
CX-Drive Ver.2.□	Application software to set and control data for Inverters and Servos.
CX-Process Tool Ver.5.□	Application software to create and debug function block programs for SYSMAC CS/CJ-series Loop Controllers (Loop Control Units/Boards, Process Control CPU Units, and Loop Control CPU Units).
Faceplate Auto-Builder for NS Ver.3.□	Application software that automatically outputs screen data as project files for Ns-series PTs from tag information in function block programs created with the CX-Process Tool.
CX-Designer Ver.3.□	Application software to create screen data for NS-series PTs.
NV-Designer Ver.1.□	Application software to create screen data for NV-series small PTs.
CX-Configurator FDT Ver.1.□	Application software for setting various units by installing its DTM module.
CX-Thermo Ver.4.□	Application software to set and control parameters in components such as Temperature Control Units.
CX-FLnet Ver.1.□	Application software for system setting and monitoring of SYSMAC CS/CJ-series FI-net Units.
Network Configurator Ver.3.□	Application software to set up tag data links for CJ2 (Built-in EtherNet/IP) CPU Units and EtherNet/IP Units.
CX-Server Ver.4.□	Middleware necessary for CX-One applications to communicate with OMRON components, such as PLCs, Display Devices, and Temperature Control Units.
PLC Tools (Installed automatically.)	A group of components used with CX-One applications, such as the CX-Programmer and CX-Integrator. Includes the following: I/O tables, PLC memory, PLC Setup, Data Tracing/Time Chart Monitoring, PLC Error Logs, File Memory, PLC clock, Routing Tables, and Data Link Tables.

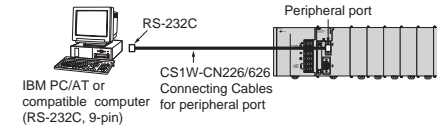
Note: Approx. 2.8 GB or more available space is required to install the complete CX-One package.

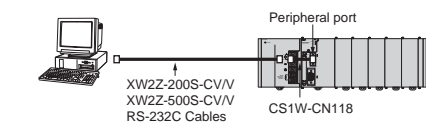
■ Cables for Connecting to Support Software in the CX-One (e.g., the CX-Programmer)

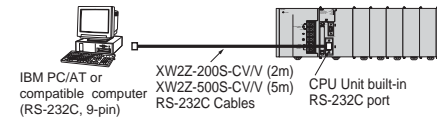
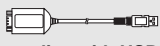
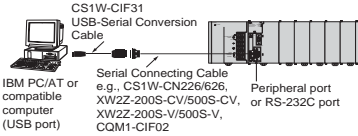

Product Name		Specifications				Model	Standards
		Applicable computers	Connection configuration	Cable length	Remarks		
Programming Device Connecting Cables for Peripheral Port 	Connects IBM PC/AT or compatible computers, D-Sub 9-pin	IBM PC/AT or compatible computer + CS1W-CN226/626 + CPU Unit peripheral port 	2 m	Used for Peripheral Bus or Host Link.	CS1W-CN226	CE	
		IBM PC/AT or compatible computer (RS-232C, 9-pin) CS1W-CN226/626 Connecting Cables for peripheral port (RS-232C, 9-pin)	6 m		CS1W-CN626		
Programming Device Connecting Cables for Peripheral Port 	Connects IBM PC/AT or compatible computers, D-Sub 9-pin	The following connection method can be used when connecting to an IBM PC/AT or compatible computer via RS-232C cable: IBM PC/AT or compatible computer + XW2Z-200S-CV/V or XW2Z-500S-CV/V + CS1W-CN118 + CPU Unit peripheral port 	0.1 m	Used for connecting XW2Z-200S-CV/V or XW2Z-500S-CV/V RS-232C Cable to the peripheral port.	CS1W-CN118	CE	
		XW2Z-200S-CV/V XW2Z-500S-CV/V RS-232C Cables					
Programming Device Connecting Cables for RS-232C Port 	Connects IBM PC/AT or compatible computers, D-Sub 9-pin	IBM PC/AT or compatible computer + XW2Z-200S-CV/V or XW2Z-500S-CV/V + RS-232C port of CPU Unit or Serial Communications Board or Unit 	2 m	Used for Peripheral Bus or Host Link. Anti-static connectors	XW2Z-200S-CV	---	
			5 m		XW2Z-500S-CV		
			2 m	Used for Host Link only.	XW2Z-200S-V		
			5 m	Peripheral Bus not supported.	XW2Z-500S-V		
USB-Serial Conversion Cable and PC driver (on a CD-ROM disk)  Complies with USB Specification 1.1.	IBM PC/AT or compatible computer (USB port)	IBM PC/AT or compatible computer + CS1W-CIF31 + CS1W-CN226/626 + CPU Unit peripheral port 	0.5 m	Used for Peripheral Bus or Host Link.	CS1W-CIF31	N	
		IBM PC/AT or compatible computer + CS1W-CIF31 + XW2Z-200S-CV/500S-CV + CS1W-CN118 + CPU Unit peripheral port					Connect USB Serial Conversion Cable to Serial Connecting Cable, and connect to the PLC peripheral port or RS-232C port.
		IBM PC/AT or compatible computer + CS1W-CIF31 + XW2Z-200S-V/500S + CS1W-CN118 + CPU Unit peripheral port					
		IBM PC/AT or compatible computer + CS1W-CIF31 + XW2Z-200S-CV/500S-CV + RS-232C port of CPU Unit or Serial Communications Unit					
		IBM PC/AT or compatible computer + CS1W-CIF31 + XW2Z-200S-V/500S-V + RS-232C port of CPU Unit or Serial Communications Unit					
		IBM PC/AT or compatible computer + CS1W-CIF31 + XW2Z-200S-V/500S-V + RS-232C port of CPU Unit or Serial Communications Unit					
IBM PC/AT or compatible computer (USB port) Serial Connecting Cable e.g., CS1W-CN226/626, XW2Z-200S-CV/500S-CV, XW2Z-200S-V/500S-V, CQM1-CIF02							

<Note>

There are two serial communications modes for connecting Support Software in the CX-One (e.g., the CX-Programmer) to the CJ Series.

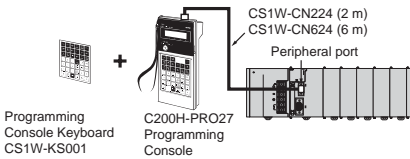

Serial communications mode	Features
Peripheral Bus	High-speed communications are enabled in the Peripheral Bus Mode, so normally connect with this serial communications mode when using Support Software in the CX-One, such as the CX-Programmer <ul style="list-style-type: none"> Supported for 1:1 connection only. The baud rate at the Support Software is automatically recognized when the connection is made.
Host Link (SYSWAY)	Host Link (SYSWAY) is generally the protocol for communications with a host computer. Either a 1:1 or 1:N connection can be used. <ul style="list-style-type: none"> Slower than the peripheral bus. Connections is possible via a modem or optical adapter, long-distance connection is possible using RS-422A/485, and 1:N connections are possible.

■ Programming Consoles

Product name	Specifications	Cable model (Purchased separately.)	Connection configuration	Model	Standards	
Programming Consoles 	Connects to peripheral port on CPU Unit only. (No connection is required at the RS-232C port.) An English Keyboard Sheet (CS1W-KS001-E) is required.	CS1W-CN224: 2 m CS1W-CN624: 6 m		C200H-PRO27-E	U, C, N, CE	
Programming Console Key Sheet	For C200H-PRO27-E.			CS1W-KS001-E	CE	
Programming Console Connecting Cables 	Connects the C200H-PRO27-E Programming Console. (Length: 2 m)			CS1W-CN224		
		Connects the C200H-PRO27-E Programming Console. (Length: 6 m)			CS1W-CN624	



Optional Products and Maintenance Products

Product name	Specifications	Model	Standards
Memory Cards 	Flash memory, 128 MB	HMC-EF183	---
	Memory Card Adapter (for computer PCMCIA slot)	HMC-AP001	CE

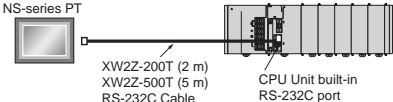
Product name	Specifications	Model	Standards
Battery Set 	Battery for CJ1G/H-CPU□□H-R/H/P CPU Unit maintenance	CPM2A-BAT01	---
	Battery for CJ1M-CPU□□CPU Unit maintenance	CJ1W-BAT01	
End Cover 	Mounted to the right-hand side of CJ-series CPU Racks or Expansion Racks.	One End Cover is provided as a standard accessory with each CPU Unit and I/O Interface Unit.	UC1, N, L, CE

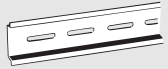

Product name	Specifications		Model	Standards
	Connection configuration	Cable length		
NS-series PT Connecting Cables 	Cable for connecting between an NS-series PT and the RS-232C port on the CPU Unit or Serial Communications Board 	2 m	XW2Z-200T	---
		5 m	XW2Z-500T	
	Cable for connecting between an NS-series PT and the peripheral port on the CPU Unit	2 m	XW2Z-200T-2	
		5 m	XW2Z-500T-2	

DIN Track Accessories

Product name	Specifications	Model	Standards
DIN Track 	Length: 0.5 m; Height: 7.3 mm	PFP-50N	---
	Length: 1 m; Height: 7.3 mm	PFP-100N	
	Length: 1 m; Height: 16 mm	PFP-100N2	
End Plate 	There are 2 stoppers provided with CPU Units and I/O Interface Units as standard accessories to secure the Units on the DIN Track.	PFP-M	



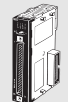
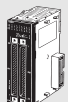

Basic I/O Units

■ Input Units

Unit classification	Product name	Specifications					Current consumption (A)		Model	Standards
		I/O points	Input voltage and current	Commons	External connection	No. of words allocated	5 V	24 V		
CJ1 Basic I/O Units	DC Input Units   	8 inputs	12 to 24 VDC, 10 mA	Independent contacts	Removable terminal block	1 word	0.08	---	CJ1W-ID201	UC1, N, L, CE
		16 inputs	24 VDC, 7 mA	16 points, 1 common	Removable terminal block	1 word	0.08	---	CJ1W-ID211	
		16 inputs <i>High-speed type</i>	24 VDC, 7 mA	16 points, 1 common	Removable terminal block	1 word	0.13	---	CJ1W-ID212	
		32 inputs	24 VDC, 4.1 mA	16 points, 1 common	Fujitsu connector	2 words	0.09	---	CJ1W-ID231 (See note.)	
		32 inputs	24 VDC, 4.1 mA	16 points, 1 common	MIL connector	2 words	0.09	---	CJ1W-ID232 (See note.)	
		32 inputs <i>High-speed type</i>	24 VDC, 4.1 mA	16 points, 1 common	MIL connector	2 words	0.20	---	CJ1W-ID233 (See note.)	
		64 inputs	24 VDC, 4.1 mA	16 points, 1 common	Fujitsu connector	4 words	0.09	---	CJ1W-ID261 (See note.)	
	64 inputs	24 VDC, 4.1 mA	16 points, 1 common	MIL connector	4 words	0.09	---	CJ1W-ID262 (See note.)		
	AC Input Units 	8 inputs	200 to 24 VAC, 10 mA (200 V, 50 Hz)	8 points, 1 common	Removable Terminal Block	1 words	0.08	---	CJ1W-IA201	
		16 inputs	100 to 120 VAC, 7 mA (100 V, 50 Hz)	16 points, 1 common	Removable Terminal Block	1 words	0.09	---	CJ1W-IA111	

Note: Connectors are not provided with these connector models. Either purchase one of the following 40-pin Connectors, or use an OMRON XW2□ Connector-Terminal Block Conversion Unit or a G7□ I/O Relay Terminal.

■ Output Units

Unit classification	Product name	Specifications					No. of words allocated	Current consumption (A)		Model	Standards
		Output type	I/O points	Maximum switching capacity	Commons	External connection		5 V	24 V		
CJ1 Basic I/O Units	Relay Contact Output Units 	---	8 outputs	250 VAC/24 VDC, 2 A	Independent contacts	Removable terminal block	1 words	0.09	0.048 max.	CJ1W-OC201	UC1, N, L, CE
		---	16 outputs	250 VAC/24 VDC, 2 A	16 points, 1 common	Removable terminal block	1 words	0.11	0.096 max.	CJ1W-OC211	
	Triac Output Unit 	---	8 outputs	250 VAC, 0.6 A	8 points, 1 common	Removable terminal block	1 words	0.22	---	CJ1W-OA201	
	Transistor Output Units   	Sinking	8 outputs	12 to 24 VDC, 2 A	4 points, 1 common	Removable terminal block	1 words	0.09	---	CJ1W-OD201	
			8 outputs	12 to 24 VDC, 0.5 A	8 points, 1 common	Removable terminal block	1 words	0.10	---	CJ1W-OD203	
			16 outputs	12 to 24 VDC, 0.5 A	16 points, 1 common	Removable terminal block	1 words	0.10	---	CJ1W-OD211	
			16 outputs <small>High-speed type</small>	24 VDC, 0.5 A	16 points, 1 common	Removable terminal block	1 words	0.15	---	CJ1W-OD213	
			32 outputs	12 to 24 VDC, 0.5 A	16 points, 1 common	Fujitsu connector	2 words	0.14	---	CJ1W-OD231 (See note.)	
			32 outputs	12 to 24 VDC, 0.5 A	16 points, 1 common	MIL connector	2 words	0.14	---	CJ1W-OD233 (See note.)	
			32 outputs <small>High-speed type</small>	24 VDC, 0.5 A	16 points, 1 common	MIL connector	2 words	0.22	---	CJ1W-OD234 (See note.)	
			64 outputs	12 to 24 VDC, 0.3 A	16 points, 1 common	Fujitsu connector	4 words	0.17	---	CJ1W-OD261 (See note.)	
		64 outputs	12 to 24 VDC, 0.3 A	16 points, 1 common	MIL connector	4 words	0.17	---	CJ1W-OD263 (See note.)		
		Sourcing	8 outputs	24 VDC, 2 A Short-circuit protection	4 points, 1 common	Removable terminal block	1 words	0.11	---	CJ1W-OD202	
			8 outputs	24 VDC, 0.5 A Short-circuit protection	8 points, 1 common	Removable terminal block	1 words	0.10	---	CJ1W-OD204	
			16 outputs	24 VDC, 0.5 A Short-circuit protection	16 points, 1 common	Removable terminal block	1 words	0.10	---	CJ1W-OD212	
32 outputs	24 VDC, 0.5 A Short-circuit protection		16 points, 1 common	MIL connector	2 words	0.15	---	CJ1W-OD232 (See note.)			
64 outputs	12 to 24 VDC, 0.3 A		16 points, 1 common	MIL connector	4 words	0.17	---	CJ1W-OD262 (See note.)			

Note: Connectors are not provided with these connector models. Either purchase one of the following 40-pin Connectors, or use an OMRON XW2□ Connector-Terminal Block Conversion Unit or a G7□ I/O Relay Terminal.

■ I/O Units

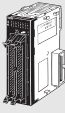
Unit classification	Product name	Specifications						Current consumption (A)		Model	Standards
		Output type	I/O points	Input voltage, Input current	Commons	External connection	No. of words allocated	5 V	24 V		
				Maximum switching capacity							
CJ1 Basic I/O Units	DC Input/Transistor Output Units 	Sinking	16 inputs	24 VDC, 7 mA	16 points, 1 common	Fujitsu connector	2 words	0.13	---	CJ1W-MD231 (See note 2.)	UC1, N, CE
			16 outputs	250 VAC/24 VDC, 0.5 A	16 points, 1 common						
		Sinking	16 inputs	24 VDC, 7 mA	16 points, 1 common	MIL connector	2 words	0.13	---	CJ1W-MD233 (See note 2.)	UC1, N, CE
			16 outputs	12 to 24 VDC, 0.5 A	16 points, 1 common						
		Sinking	32 inputs	24 VDC, 4.1 mA	16 points, 1 common	Fujitsu connector	4 words	0.14	---	CJ1W-MD261 (See note 1.)	
	32 outputs		12 to 24 VDC, 0.3 A	16 points, 1 common							
	Sinking	32 inputs	24 VDC, 4.1 mA	16 points, 1 common	MIL connector	4 words	0.14	---	CJ1W-MD263 (See note 1.)		
		32 outputs	12 to 24 VDC, 0.3 A	16 points, 1 common							
	Sourcing	16 inputs	24 VDC, 7 mA	16 points, 1 common	MIL connector	2 words	0.13	---	CJ1W-MD232 (See note 2.)	UC1, N, L, CE	
		16 outputs	24 VDC, 0.5 A Short-circuit protection	16 points, 1 common							
TTL I/O Units 	---	32 inputs	5 VDC, 35 mA	16 points, 1 common	MIL connector	4 words	0.19	---	CJ1W-MD563 (See note 1.)	UC1, N, CE	
		32 outputs	5 VDC, 35 mA	16 points, 1 common							

Note 1. Connectors are not provided with these connector models. Either purchase one of the following 40-pin Connectors, or use an OMRON XW2□ Connector-Terminal Block Conversion Unit or a G7□ I/O Relay Terminal.

Note 2. Connectors are not provided with these connector models. Either purchase one of the following 20-pin or 24-pin Connectors, or use an OMRON XW2□ Connector-Terminal Block Conversion Unit or a G7□ I/O Relay Terminal.

● Applicable Connectors

Fujitsu Connectors for 32-input, 32-output, 64-input, 64-output, 32-input/32-output, and 16-input/16-output Units

Name	Connection	Part name	Applicable Units	Model	Standards
40-pin Connectors	Soldered	FCN-361J040-AU Connector FCN-360C040-J2 Connector Cover	Fujitsu Connectors: CJ1W-ID231(32 inputs): 1 per Unit CJ1W-ID261 (64 inputs) 2 per Unit CJ1W-OD231 (32 outputs):1 per Unit CJ1W-OD261 (64 outputs): 2 per Unit CJ1W-MD261 (32 inputs, 32 outputs): 2 per Unit	C500-CE404	---
	Crimped	FCN-363J040 Housing FCN-363J-AU Contactor FCN-360C040-J2 Connector Cover		C500-CE405	
	Pressure welded	FCN-367J040-AU/F		C500-CE403	
24-pin Connectors	Soldered	FCN-361J024-AU Connector FCN-360C024-J2 Connector Cover	Fujitsu Connectors: CJ1W-MD231 (16 inputs, 16 outputs): 2 per Unit	C500-CE241	---
	Crimped	FCN-363J024 Housing FCN-363J-AU Contactor FCN-360C024-J2 Connector Cover		C500-CE242	
	Pressure welded	FCN-367J024-AU/F		C500-CE243	

MIL Connectors for 32-input, 32-output, 64-input, 64-output, 32-input/32-output, and 16-input/16-output Units

Name	Connection	Part name	Applicable Units	Model	Standards
40-pin Connectors	Pressure welded	FRC5-AO40-3TOS	MIL Connectors: CJ1W-ID232 (32 inputs): 1 per Unit CJ1W-OD232/233 (32 outputs): 1 per Unit CJ1W-ID262 (64 inputs): 2 per Unit CJ1W-OD262/263 (64 outputs): 2 per Unit CJ1W-MD263/563 (32 inputs, 32 outputs): 2 per Unit	XG4M-4030-T	---
20-pin Connectors	Pressure welded	FRC5-AO20-3TOS	MIL Connectors: CJ1W-MD232/233 (16 inputs, 16 outputs): 2 per Unit	XG4M-2030-T	

■ Interrupt Input Units

Unit classification	Product name	Specifications						No. of words allocated	Current consumption (A)		Model	Standards
		I/O points	Input voltage current	Commons	Input pulse width conditions	Max. Units mountable per Unit	External connection		5 V	24 V		
CJ1 Basic I/O Units	Interrupt Input Unit 	16 inputs	24 VDC, 7 mA	16 points, 1 common	ON time: 0.05 ms max. OFF time: 0.5 ms max.	2	Removable terminal block	1 word	0.08	---	CJ1W-INT01	UC1, N, L, CE

- Note 1.** Can be used only on CPU Racks, and not on Expansion Racks.
2. The locations where the Units can be mounted depend on the CPU Rack and the CPU Unit model.
 CJ2H: From the slot next to the CPU Unit until the four slot.
 CJ1G, CJ1H: From the slot next to the CPU Unit until the fifth slot.
 CJ1M: From the slot next to the CPU Unit until the third slot.

■ Quick-response Input Units

Unit classification	Product name	Specifications					No. of words allocated	Current consumption (A)		Model	Standards
		I/O points	Input voltage, Input current	Commons	Input pulse width conditions	External connection		5 V	24 V		
CJ1 Basic I/O Units	High-speed Input Unit 	16 inputs	24 VDC, 7 mA	16 points, 1 common	ON time: 0.05 ms max. OFF time: 0.5 ms max.	Removable terminal block	1 word	0.08	---	CJ1W-IDP01	UC1, N, L, CE

Note: There are no restrictions on the mounting position or number of Units.

■ B7A Interface Units

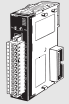
Unit classification	Product name	Specifications				No. of words allocated	Current consumption (A)		Model	Standards
		I/O points	Send delay time	Output status when error occurs	External connection		5 V	24 V		
CJ1 Basic I/O Units	B7A Interface Units 	64 inputs	Switchable between the following: Standard: 19.2 ms typ. High-speed: 3 ms typ.	Hold	Removable terminal block	4 words	0.07	---	CJ1W-B7A14	UC1, CE
		64 outputs		---			CJ1W-B7A04			
		32 inputs/ outputs		Hold (inputs only)			0.07	---	CJ1W-B7A22	

Special I/O Units and CPU Bus Units

■ Process I/O Units

● Isolated-type Units with Universal Inputs

Unit classification	Product name	Input points	Signal range selection	Signal range	Conversion speed (resolution)	Accuracy (at ambient temperature of 25°C)	External connection	No. of unit numbers allocated	Current consumption (A)		Model	Standards
									5 V	24 V		
CJ1 Special I/O Units	Process Input Units (Isolated-type Units with Universal Inputs) 	4 inputs	Set separately for each input	Universal inputs: Pt100 (3-wire), JPt100 (3-wire), Pt1000 (3-wire), Pt100 (4-wire), K, J, T, E, L, U, N, R, S, B, WRe5-26, PL II, 4 to 20 mA, 0 to 20 mA, 1 to 5 V, 0 to 1.25 V, 0 to 5 V, 0 to 10 V, ±100 mV selectable range -1.25 to 1.25 V, -5 to 5 V, -10 to 10 V, ±10 V selectable range, potentiometer	Resolution (conversion speed): 1/256,000 (conversion cycle: 60 ms/ 4 inputs) 1/64,000 (conversion cycle: 10 ms/ 4 inputs) 1/16,000 (conversion cycle: 5 ms/ 4 inputs)	Standard accuracy: ±0.05% of F.S.	Removable terminal block	1	0.30	---	CJ1W-PH41U (See note 1.)	UC1, CE
		4 inputs	Set separately for each input	Universal inputs: Pt100, JPt100, Pt1000, K, J, T, L, R, S, B, 4 to 20 mA, 0 to 20 mA, 1 to 5 V, 0 to 5 V, 0 to 10 V	Conversion speed: 250 ms/ 4 inputs	Accuracy: Platinum resistance thermometer input: (±0.3% of PV or ±0.8°C, whichever is larger) ±1 digit max. Thermocouple input: (±0.3% of PV or ±1.5°C, whichever is larger) ±1 digit max. (See note 2.) Voltage or current input: ±0.3% of F.S. ±1 digit max.			0.32	---	CJ1W-AD04U	UC1, L, CE

Note 1. When using the CJ1W-PH41U, do not mount a Relay Output Unit in the same CPU Rack or Expansion Rack.

2. L and -100°C or less for K and T are ±2°C±1 digit max., and 200°C or less for R and S is ±3°C±1 digit max. No accuracy is specified for 400°C or less for B.

● Isolated-type Thermocouple Input Units

Unit classification	Product name	Input points	Signal range selection	Signal range	Conversion speed (resolution)	Accuracy (at ambient temperature of 25°C)	External connection	No. of unit numbers allocated	Current consumption (A)		Model	Standards
									5 V	24 V		
CJ1 Special I/O Units	Process Input Units (Isolated-type Thermocouple Input Units) 	2 inputs	Set separately for each input	Thermocouple: B, E, J, K, L, N, R, S, T, U, WRe5-26, PLII DC voltage: ±100 mV	Conversion speed: 10 ms/ 2 inputs, Resolution: 1/64,000	Standard accuracy: ±0.05% of F.S. (See note 1.)	Removable terminal block	1	0.18	0.06 (See note 2.)	CJ1W-PTS15	UC1, CE
		4 inputs	Thermocouple: R, S, K, J, T, L, B	Conversion speed: 250 ms/ 4 inputs	Accuracy: (±0.3% of PV or ±1°C, whichever is larger) ±1 digit max. (See note 3.)	0.25			---	CJ1W-PTS51		

Note 1. The accuracy depends on the sensors used and the measurement temperatures. For details, refer to the user's manual.

2. This is for an external power supply, and not for internal current consumption.

3. L and -100°C or less for K and T are ±2°C±1 digit max., and 200°C or less for R and S is ±3°C±1 digit max. No accuracy is specified for 400°C or less for B.

● Isolated-type Resistance Thermometer Input Units

Unit classification	Product name	Input points	Signal range selection	Signal range	Conversion speed (resolution)	Accuracy (at ambient temperature of 25°C)	External connection	No. of unit numbers allocated	Current consumption (A)		Model	Standards
									5 V	24 V		
CJ1 Special I/O Units	Process Analog Input Units (Isolated-type Resistance Thermometer Input Units) 	2 inputs	Set separately for each input	Resistance thermometer: Pt100, JPt100, Pt50, Ni508.4	Conversion speed: 10 ms/2 inputs, Resolution: 1/64,000	Accuracy: ±0.05% of F.S. or ±0.1°C, whichever is larger.	Removable terminal block	1	0.18	0.07 (See note.)	CJ1W-PTS16	UC1, CE
		4 inputs	Common inputs	Resistance thermometer: Pt100, JPt100	Conversion speed: 250 ms/4 inputs	Accuracy: ±0.3°C of PV or ±0.8°C, whichever is larger, ±1 digit max.			0.25	---	CJ1W-PTS52	

Note: This is for an external power supply, and not for internal current consumption.



● Isolated-type DC Input Units

Unit classification	Product name	Input points	Signal range selection	Conversion speed (resolution)	Accuracy (at ambient temperature of 25°C)	External connection	No. of unit numbers allocated	Current consumption (A)		Model	Standards
								5 V	24 V		
CJ1 Special I/O Units	Isolated-type DC Input Units 	2 inputs	DC voltage: 0 to 1.25 V, -1.25 to 1.25 V, 0 to 5 V, 1 to 5 V, -5 to 5 V, 0 to 10 V, -10 to 10 V, ±10 V selectable range DC current: 0 to 20 mA, 4 to 20 mA	Conversion speed: 10 ms/2 inputs Resolution: 1/64,000	Standard accuracy: ±0.05% of F.S.	Removable terminal block	1	0.18	0.09 (See note.)	CJ1W-PDC15	UC1, CE

Note: This is for an external power supply, and not for internal current consumption.



■ Analog I/O Units

● Analog Input Units

Unit type	Product name	Input points	Signal range selection	Signal range	Resolution	Conversion period	Accuracy (at ambient temperature of 25°C)	External connection	No. of unit numbers allocated	Current consumption (A)		Model	Standards			
										5 V	24 V					
CJ1 Special I/O Units	Analog Input Unit High-speed type 	4 inputs	Set separately for each input	1 to 5 V (1/10,000), 0 to 10 V (1/20,000), -5 to 5 V (1/20,000), -10 to 10 V (1/40,000), and 4 to 20 mA (1/10,000)	20 μs/1 point, 25 μs/2 points, 30 μs/3 points, 35 μs/4 points The Direct conversion is provided.	Voltage: ±0.2% of F.S. Current: ±0.4% of F.S.	Removable terminal block	1	0.52	---	CJ1W-AD042	UC1, CE				
	Analog Input Units 	8 inputs							1 to 5 V, 0 to 5 V, 0 to 10 V, -10 to 10 V, 4 to 20 mA	1/4,000 (Settable to 1/8,000) (See note 1.)	1 ms/point (250 μs/point can also be set.) (See note 1.)	Voltage: ±0.2% of F.S. Current: ±0.4% of F.S. (See note 2.)	0.42	---	CJ1W-AD081-V1	UC1, N, L, CE
		4 inputs													CJ1W-AD041-V1	

Note 1. The resolution and conversion speed cannot be set independently. If the resolution is set to 1/4,000, then the conversion speed will be 1 ms/point.
2. At 23 ±2°C

● Analog Output Units

Unit type	Product name	Output points	Signal range selection	Signal range	Resolution	Conversion period	Accuracy (at ambient temperature of 25°C)	External connection	External power supply	No. of unit numbers allocated	Current consumption (A)		Model	Standards
											5 V	24 V		
CJ1 Special I/O Units	Analog Output Unit 	4 outputs	Set separately for each output	1 to 5 V (1/10,000), 0 to 10 V (1/20,000), and -10 to 10 V (1/40,000)	1/4,000 (Settable to 1/8,000) (See note 1.)	20 μs/ 1 point, 25 μs/ 2 points, 30 μs/ 3 points, 35 μs/ 4 points The Direct conversion is provided.	±0.3% of F.S.	Removable terminal block	---	1	0.40	---	CJ1W-DA042V	UC1, CE
	Analog Output Units 	8 outputs		1 to 5 V, 0 to 5 V, 0 to 10 V, -10 to 10 V		1 ms/point (Settable to 250 μs/point) (See note 1.)			±0.3% of F.S.		24 VDC +10% -15% , 140 mA max.	0.14 (See note 2.)	CJ1W-DA08V	UC1, N, L, CE
		8 outputs		4 to 20 mA		1 ms/point (See note 1.)					24 VDC +10% -15% , 170 mA max.		CJ1W-DA08C	UC1, N, CE
		4 outputs		1 to 5 V, 0 to 5 V, 0 to 10 V, -10 to 10 V, 4 to 20 mA		1/4,000					1 ms/point		Voltage: ±0.3% of F.S. Current: ±0.5% of F.S.	24 VDC +10% -15% , 200 mA max.
2 outputs	24 VDC +10% -15% , 140 mA max.	CJ1W-DA021												

Note 1. The resolution and conversion speed cannot be set independently. If the resolution is set to 1/4,000, the conversion speed will be 1 ms/point.
2. This is for an external power supply, and not for internal current consumption.

● Analog I/O Units

Unit classification	Product name	No. of points	Signal range selection	Signal range	Resolution (See note.)	Conversion period (See note.)	Accuracy (at ambient temperature of 25°C)	External connection	No. of unit numbers allocated	Current consumption (A)		Model	Standards
										5 V	24 V		
CJ1 Special I/O Units	Analog I/O Units 	4 inputs 2 outputs	Set separately for each input	1 to 5 V, 0 to 5 V, 0 to 10 V, -10 to 10 V, 4 to 20 mA	1/4,000 (Settable to 1/8,000)	1 ms/point (Settable to 500 μs/point max.)	Voltage input: ±0.2% of F.S. Current input: ±0.2% of F.S. Voltage output: ±0.3% of F.S. Current output: ±0.3% of F.S.	Removable terminal block	1	0.58	---	CJ1W-MAD42	UC1, N, L, CE

Note: The resolution and conversion speed cannot be set independently. If the resolution is set to 1/4,000, then the conversion speed will be 1 ms/point.

■ Temperature Control Units

Unit classification	Product name	Specifications			No. of unit numbers allocated	Current consumption (A)		Model	Standards
		No. of loops	Temperature sensor inputs	Control outputs		5 V	24 V		
CJ1 Special I/O Units	 Temperature Control Units	4 loops	Thermocouple input (R, S, K, J, T, B, L)	Open collector NPN outputs (pulses)	2	0.25	---	CJ1W-TC001	UC1, N, L, CE
		4 loops		Open collector PNP outputs (pulses)		0.25	---	CJ1W-TC002	
		2 loops, heater burnout detection function		Open collector NPN outputs (pulses)		0.25	---	CJ1W-TC003	
		2 loops, heater burnout detection function		Open collector PNP outputs (pulses)		0.25	---	CJ1W-TC004	
		4 loops	Platinum resistance thermometer input (JPt100, Pt100)	Open collector NPN outputs (pulses)		0.25	---	CJ1W-TC101	
		4 loops		Open collector PNP outputs (pulses)		0.25	---	CJ1W-TC102	
		2 loops, heater burnout detection function		Open collector NPN outputs (pulses)		0.25	---	CJ1W-TC103	
		2 loops, heater burnout detection function		Open collector PNP outputs (pulses)		0.25	---	CJ1W-TC104	

■ High-speed Counter Unit

Unit classification	Product name	Specifications			No. of unit numbers allocated	Current consumption (A)		Model	Standards
		Countable channels	Encoder A and B inputs, pulse input Z signals	Max. counting rate		5 V	24 V		
CJ1 Special I/O Units	 High-speed Counter Unit	2	Input voltage: 5 VDC, 12 V, or 24 V (5 V and 12 V are each for one axis only.)	50 kHz	4	0.28	---	CJ1W-CT021	UC1, N, L, CE
			RS-422 line driver	500 kHz					

■ Position Control Units
 ● Position Control Units (High-speed type)

Unit classification	Product name	Specifications		No. of unit numbers allocated	Current consumption (A)		Model	Standards		
		Control output interface			No. of axes	5 V			24 V	
CJ1 Special I/O Units	Position Control Units <small>High-speed type</small>	Pulse-train open-collector output with Pulse Counter Function		2 axes	2	0.27	---	CJ1W-NC214	UC1, CE	
				4 axes		0.31	---	CJ1W-NC414		
		Pulse-train line-driver output with Pulse Counter Function		2 axes	2	0.27	---	CJ1W-NC234		
				4 axes		0.31	---	CJ1W-NC434		
	Position Control Unit Cables	Open-collector output	For CJ1W-NC214/NC414	Connecting Servo Drives: G Series R88D-GT G5 Series R88D-KT		1 axis	Cable length: 1 m		XW2Z-100J-G13	---
				Connecting Servo Drives: SMARTSTEP2 R7D-BP			Cable length: 3 m		XW2Z-300J-G13	
				Connecting Servo Drives: G Series R88D-GT G5 Series R88D-KT			Cable length: 1 m		XW2Z-100J-G14	
				Connecting Servo Drives: SMARTSTEP2 R7D-BP			Cable length: 3 m		XW2Z-300J-G14	
				Connecting Servo Drives: G Series R88D-GT G5 Series R88D-KT		2 axes	Cable length: 1 m		XW2Z-100J-G5	
				Connecting Servo Drives: SMARTSTEP2 R7D-BP			Cable length: 3 m		XW2Z-300J-G5	
				Connecting Servo Drives: G Series R88D-GT G5 Series R88D-KT			Cable length: 1 m		XW2Z-100J-G6	
				Connecting Servo Drives: SMARTSTEP2 R7D-BP			Cable length: 3 m		XW2Z-300J-G6	
		Line-driver output	For CJ1W-NC234/NC434	Connecting Servo Drives: G Series R88D-GT G5 Series R88D-KT		1 axis	Cable length: 1 m		XW2Z-100J-G9	
				Connecting Servo Drives: SMARTSTEP2 R7D-BP			Cable length: 5 m		XW2Z-500J-G9	
				Connecting Servo Drives: SMARTSTEP2 R7D-BP			Cable length: 10 m		XW2Z-10MJ-G9	
				Connecting Servo Drives: SMARTSTEP2 R7D-BP			Cable length: 1 m		XW2Z-100J-G12	
				Connecting Servo Drives: SMARTSTEP2 R7D-BP		Cable length: 5 m		XW2Z-500J-G12		
				Connecting Servo Drives: SMARTSTEP2 R7D-BP		Cable length: 10 m		XW2Z-10MJ-G12		
				Applicable Servo Drive: G Series R88D-GT G5 Series R88D-KT		2 axes	Cable length: 1 m		XW2Z-100J-G1	
				Applicable Servo Drive: G Series R88D-GT G5 Series R88D-KT			Cable length: 5 m		XW2Z-500J-G1	
Applicable Servo Drive: G Series R88D-GT G5 Series R88D-KT		Cable length: 10 m		XW2Z-10MJ-G1						
Applicable Servo Drive: SMARTSTEP2 R7D-BP		Cable length: 1 m		XW2Z-100J-G4						
Applicable Servo Drive: SMARTSTEP2 R7D-BP		Cable length: 5 m		XW2Z-500J-G4						
Applicable Servo Drive: SMARTSTEP2 R7D-BP		Cable length: 10 m		XW2Z-10MJ-G4						

● Position Control Units

Unit classification	Product name	Specifications			No. of unit numbers allocated	Current consumption (A)		Model	Standards	
		Control output interface		No. of axes		5 V	24 V			
CJ1 Special I/O Units	Position Control Units 	Pulse train, open collector output		1 axis	1	0.25	---	CJ1W-NC113	UC1, CE	
		Pulse train, open collector output		2 axes		0.25	---	CJ1W-NC213		
		Pulse train, open collector output (See note.)		4 axes	2	0.36	---	CJ1W-NC413		
		Pulse train, line driver output		1 axis		1	0.25	---		CJ1W-NC133
		Pulse train, line driver output		2 axes	0.25		---	CJ1W-NC233		
		Pulse train, line driver output (See note.)		4 axes	2	0.36	---	CJ1W-NC433		
	Space Unit	Use a CJ1W-SP001 Space Unit if the operating temperature is 0 to 55°C.						CJ1W-SP001	UC1, CE	
	Servo Relay Units	For 1-Axis Position Control Unit (without communications support) (CJ1W-CN113/133)						XW2B-20J6-1B	---	
		For 2- or 4-Axes Position Control Unit (without communications support) (CJ1W-NC213/233/413/433)						XW2B-40J6-2B		
		For 2- or 4-Axes Position Control Unit (with communications support) (CJ1W-NC213/233/413/433)						XW2B-40J6-4A		
	Position Control Unit Cables	Open-collector output	For CJ1W-NC113	Connecting Servo Drives: G5/G Series, SMARTSTEP2		1 axis	Cable length: 0.5 m		XW2Z-050J-A14	---
				Connecting Servo Drives: G5/G Series, SMARTSTEP2			Cable length: 1 m		XW2Z-100J-A14	
			For CJ1W-NC213/413	Connecting Servo Drives: G5/G Series, SMARTSTEP2		2 axes	Cable length: 0.5 m		XW2Z-050J-A15	
				Connecting Servo Drives: G5/G Series, SMARTSTEP2			Cable length: 1 m		XW2Z-100J-A15	
Line-driver output		For CJ1W-NC133	Connecting Servo Drives: G5/G Series, SMARTSTEP2		1 axis	Cable length: 0.5 m		XW2Z-050J-A18		
			Connecting Servo Drives: G5/G Series, SMARTSTEP2			Cable length: 1 m		XW2Z-100J-A18		
		For CJ1W-NC233/433	Connecting Servo Drives: G5/G Series, SMARTSTEP2		2 axes	Cable length: 0.5 m		XW2Z-050J-A19		
			Connecting Servo Drives: G5/G Series, SMARTSTEP2			Cable length: 1 m		XW2Z-100J-A19		

Note: The ambient operating temperature for 4-Axes Position Control Units is 0 to 50°C; the allowable voltage fluctuation on the external 24-VDC power supply is 22.8 to 25.2 VDC (24 V ±5%).

■ Position Control Unit with EtherCAT interface

Unit classification	Product name	Specifications		No. of unit numbers allocated	Current consumption (A)		Model	Standards
		Control output interface	No. of axes		5 V	24 V		
CJ1 CPU Bus Units	Position Control Unit with EtherCAT interface 	Control commands executed by EtherCAT communications. Positioning functions: Memory operation, Direct operation by ladder programming	2 axes	1	0.46	---	CJ1W-NC281	UC1, CE
			4 axes				CJ1W-NC481	
			8 axes				CJ1W-NC881	
			16 axes				CJ1W-NCF81	
		Control commands executed by EtherCAT communications. Positioning functions: Memory operation, Direct operation by ladder programming I/O communications: 64 nodes	4 axes	1	0.46	---	CS1W-NC482	
			8 axes				CS1W-NC882	



● Recommended EtherCAT Communications Cables

Category 5 or higher (100BASE-TX) straight cable with double shielding (aluminum tape and braided shielding) is recommended.

Cabel with Connectors

Wire Gauge and Number of Pairs: AWG22, 2-pair Cable

As of October 2010

Item	Appearance	Recommended manufacturer	Cable length (m)	Model
Cable with Connectors on Both Ends (RJ45/RJ45)		OMRON	0.3	XS5W-T421-AMD-K
			0.5	XS5W-T421-BMD-K
			1	XS5W-T421-CMD-K
			2	XS5W-T421-DMD-K
			5	XS5W-T421-GMD-K
			10	XS5W-T421-JMD-K
Cable with Connectors on Both Ends (M12/RJ45)			0.3	XS5W-T421-AMC-K
			0.5	XS5W-T421-BMC-K
			1	XS5W-T421-CMC-K
			2	XS5W-T421-DMC-K
		5	XS5W-T421-GMC-K	
		10	XS5W-T421-JMC-K	

Note: The cable length 0.3, 0.5, 1, 2, 3, 5, 10 and 15m are available. For details, refer to Cat.No.G019.

Cabel with Connectors

Wire Gauge and Number of Pairs: AWG24, 4-pair Cable

As of June 2010

Item	Appearance	Recommended manufacturer	Model
Cable	---	Tonichi Kyosan Cable, Ltd.	NETSTAR-C5E SAB 0.5 × 4P
	---	Kuramo Electric Co.	KETH-SB
	---	SWCC Showa Cable Systems Co.	FAE-5004
Connector	---	Panduit Corporation	MPS588

Wire Gauge and Number of Pairs: AWG22, 2-pair Cable

As of June 2010

Item	Appearance	Recommended manufacturer	Model
Cable	---	Kuramo Electric Co.	KETH-PSB-OMR *
RJ45 Assembly Connector		OMRON	XS6G-T421-1 *

* We recommend you to use above cable and connector together.

■ Position Control Units with MECHATROLINK-II interface



Unit classification	Product name	Repeater		No. of unit numbers allocated	Current consumption (A)		Model	Standards
		Control output interface	No. of axes		5 V	24 V		
CJ1 CPU Bus Units	Position Control Units with MECHATROLINK-II interface 	Control commands executed by MECHATROLINK-II synchronous communications. Direct operation by ladder programming. Control mode: Position control, speed control, or torque control	2 axes	1	0.36	---	CJ1W-NC271	UC1, CE
			4 axes				CJ1W-NC471	
			16 axes				CJ1W-NCF71	
			16 axes				CJ1W-NCF71-MA	
	MECHATROLINK-II Cables	MECHATROLINK-II Cables (without ring core and USB connector on both ends) (Yaskawa Electric Corporation) Note: Can be connected to R88D-GN and R88D-KN only.	Cable length: 0.5 m		FNY-W6002-A5	---		
			Cable length: 1 m		FNY-W6002-01			
			Cable length: 3 m		FNY-W6002-03			
			Cable length: 5 m		FNY-W6002-05			
			MECHATROLINK-II Cables (with ring core and USB connector on both ends) (Yaskawa Electric Corporation) Use the model numbers provided in this catalog when ordering from OMRON.	Cable length: 0.5 m		FNY-W6003-A5	---	
				Cable length: 1 m		FNY-W6003-01		
				Cable length: 3 m		FNY-W6003-03		
				Cable length: 5 m		FNY-W6003-05		
				Cable length: 10 m		FNY-W6003-10		
Cable length: 20 m				FNY-W6003-20				
MECHATROLINK-II Terminating Resistors	Terminating Resistor for MECHATROLINK-II (Yaskawa Electric Corporation) Use the model numbers provided in this catalog when ordering from OMRON.				FNY-W6022	---		
MECHATROLINK-II Repeater	Repeater				FNY-REP2000	---		

■ Motion Control Units with MECHATROLINK-II interface

Unit classification	Product name	Specifications	No. of unit numbers allocated	Current consumption (A)		Model	Standards
				5 V	24 V		
CJ1 CPU Bus Units	Motion Control Units with MECHATROLINK-II interface 	Position, speed, and torque commands by MECHATROLINK-II 32 axes max. (Physical axes: 30, Virtual axes: 2) Motion control language	1	0.6	---	CJ1W-MCH71	UC1, CE
	MECHATROLINK-II Cables	MECHATROLINK-II Cables (without ring core and USB connector on both ends) (Yaskawa Electric Corporation) Note: Can be connected to R88D-GN and R88D-KN only.	Cable length: 0.5 m	FNY-W6002-A5		---	
			Cable length: 1 m	FNY-W6002-01			
			Cable length: 3 m	FNY-W6002-03			
			Cable length: 5 m	FNY-W6002-05			
		MECHATROLINK-II Cables (with ring core and USB connector on both ends) (Yaskawa Electric Corporation) Use the model numbers provided in this catalog when ordering from OMRON.	Cable length: 0.5 m	FNY-W6003-A5		---	
			Cable length: 1 m	FNY-W6003-01			
			Cable length: 3 m	FNY-W6003-03			
			Cable length: 5 m	FNY-W6003-05			
	MECHATROLINK-II Terminating Resistors Terminating Resistor for MECHATROLINK-II (Yaskawa Electric Corporation) Use the model numbers provided in this catalog when ordering from OMRON.	FNY-W6022		---			
		MECHATROLINK-II Repeater For more than 15 slaves/30 m	FNY-REP2000		---		
MECHATROLINK-II 24-VDC I/O Module Inputs: 64 Outputs: 64		FNY-IO2310					
MECHATROLINK-II Counter Module Reversible counter, 2 words		FNY-PL2900					
MECHATROLINK-II Pulse Output Module Pulse train positioning, 2 words		FNY-PL2910					

Note: The CJ1W-MCH71 requires the space of three Units (but just one unit number). A maximum of 10 Units can be mounted on a single CJ-series Rack, up to three CJ1W-MCH71 Motion Control Units plus one other Unit can be mounted per Rack.

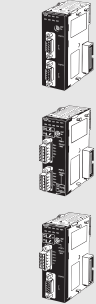
■ Serial Communications Units

Unit classification	Product name	Specifications		No. of unit numbers allocated	Current consumption (A)		Model	Standards
		Communications Interface	Communications functions		5 V	24 V		
CJ1 CPU Bus Units	Serial Communications Units High-speed type 	2 RS-232C ports	The following functions can be selected for each port: Protocol macro Host Link NT Links (1:N mode) Serial Gateway No-protocol Modbus-RTU Slave	1	0.29 (See note 1.)	---	CJ1W-SCU22	UC1, N, L, CE
		2 RS-422A/485 ports			0.46	---	CJ1W-SCU32	
		1 RS-232C port and 1 RS-422A/485 port			0.38 (See note 1.)	---	CJ1W-SCU42	
	Serial Communications Units 	2 RS-232C ports	The following functions can be selected for each port: Protocol macro Host Link NT Links (1:N mode) Serial Gateway (See note 2.) No-protocol (See note 3.) Modbus-RTU Slave (See note 4.)	1	0.28 (See note 1.)	---	CJ1W-SCU21-V1	UC1, N, L, CE
		2 RS-422A/485 ports			0.38	---	CJ1W-SCU31-V1	
		1 RS-232C port and 1 RS-422A/485 port			0.38 (See note 1.)	---	CJ1W-SCU41-V1	

Note 1. When an NT-AL001 RS-232C/RS-422A Conversion Unit is used, this value increases by 0.15 A/Unit.
Note 2. The Serial Gateway function is enabled only for Serial Communications Units of unit version 1.2 and later.
Note 3. The no-protocol function is enabled only for Serial Communications Units of unit version 1.2 and later (and a CPU Unit of unit version 3.0 or later is also required).
Note 4. The Modbus-RTU Slave function is enabled only for Serial Communications Units of unit version 1.3 and later.

■ EtherNet/IP Unit



Unit classification	Product name	Specifications			No. of unit numbers allocated	Current consumption (A)		Model	Standards
		Communications cable	Communications functions	Max.Units mountable per CPU Unit		5 V	24 V		
CJ1 CPU Bus Unit	EtherNet/IP Unit 	STP (shielded twisted-pair) cable of category 5, 5e, or higher.	Tag data link message service	8	1	0.41	---	CJ1W-EIP21	UC1, N, L, CE

■ Ethernet Unit

Unit classification	Product name	Specifications			No. of unit numbers allocated	Current consumption (A)		Model	Standards
		Communications cable	Communications functions	Max.Units mountable per CPU Unit		5 V	24 V		
CJ1 CPU Bus Unit	Ethernet Unit 	100Base-TX	FINS communications service (TCP/IP, UDP/IP), FTP server functions, socket services, mail transmission service, mail reception (remote command receive), automatic adjustment of PLC's built-in clock, server/host name specifications	4 (See note.)	1	0.37	---	CJ1W-ETN21	UC1, N, L, CE

Note: Up to three Ethernet Units can be connected to a CJ1M-CPU1□-ETN CPU Unit.

● Industrial Switching Hubs

Product name	Appearance	Specifications			Accessories	Current consumption (A)	Model	Standards
		Functions	No. of ports	Failure detection				
Industrial Switching Hubs		Quality of Service (QoS): EtherNet/IP control data priority Failure detection: Broadcast storm and LSI error detection 10/100BASE-TX, Auto-Negotiation	3	No	• Power supply connector	0.22	W4S1-03B	UC, CE
	5		No	0.22		W4S1-05B		
			5	Yes	• Power supply connector • Connector for informing error	0.22	W4S1-05C	CE

■ Controller Link Units

● Controller Link Units

Unit classification	Product name	Specifications				No. of unit numbers allocated	Current consumption (A)		Model	Standards
		Communications cable	Communications type	Duplex support	Max. Units mountable per CPU Unit		5 V	24 V		
CJ1 CPU Bus Unit	Controller Link Unit 	Wired shielded twisted-pair cable (See note.)	Data links and message service	No	8	1	0.35	---	CJ1W-CLK23	UC1, N, L, CE

Note: Use the following special cable for shielded, twisted-pair cable.

- ESVC0.5 × 2C-13262 (Bando Electric Wire: Japanese Company)
- ESNC0.5 × 2C-99-087B (Nihon Electric Wire & Cable Corporation: Japanese Company)
- ESPC 1P × 0.5 mm² (Nagaoka Electric Wire Co., Ltd.: Japanese Company)
- Li2Y-FCY2 × 0.56qmm (Kromberg & Schubert, Komtec Department: German Company)
- 1 × 2 × AWG-20PE+Tr.CUSN+PVC (Draka Cables Industrial: Spanish Company)
- #9207 (Belden: US Company)

● Controller Link Support Boards

Unit classification	Specification		Accessories	Model	Standards
	Communications cable	Communications type			
Controller Link Support Board for PCI Bus 	Wired shielded twisted-pair cable	Data link and message service	<ul style="list-style-type: none"> • CD-ROM × 1 (See note.) • INSTALLATION GUIDE (W467) × 1 • Communications connector × 1 	3G8F7-CLK23-E	CE

Note: The CD-ROM contains the following software.

- Controller Link (PCI) Driver
- FinsGateway Version 2003 (PCI-CLK Edition)
- FinsGateway Version 3 (PCI-CLK Edition)
- Setup Diagnostic Utility
- C Library

● Repeater Units

Unit classification	Specifications	Model	Standards
Controller Link Repeater Unit 	Wire-to-wire Model	CS1W-RPT01	UC1, CE
	Wire-to-Optical (H-PCF) Model (See note 2.)	CS1W-RPT02	
	Wire-to-Optical (GI) Model (See note 3.)	CS1W-RPT03	

Note 1. Using Repeater Units enables T-branches and long-distance wiring for Wired Controller Link networks. 62-node configurations, and converting part of the network to optical cable.



- When using wire-to-optical (H-PCF) cable, use a H-PCF cable (for both Controller Link and SYSMAC LINK) or a H-PCF optical fiber cable with connector.
- When using wire-to-optical (GI) cable, use a GI optical cable (for Controller Link).

● Relay Terminal Block

Unit classification	Specifications	Model	Standards
Relay Terminal Block for Wired Controller Link Unit 	Use for Wired Controller Link Units (set of 5).	CJ1W-TB101	---

Note: Controller Link Units can be replaced without stopping the communications of the entire network if a Relay Terminal Block is installed in advance on the Unit in a Wired Controller Link network. Relay Blocks cannot be used on Controller Link Support Boards.

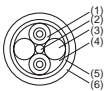
● H-PCF Cables and Optical Connectors

Name	Application/construction	Specifications	Model	Standards	
Optical Fiber Cables	Controller Link, SYSMAC LINK, SYSBUS  (1) Optical fiber single-core cord (2) Tension member (plastic-sheathed wire) (3) Filler (plastic) (4) Filler surrounding signal wires (plastic, yarn, or fiber) (5) Holding tape (plastic) (6) Heat-resistant PV sheath	Two-core optical cable with tension member	Black 10 m	S3200-HCCB101	---
			Black 50 m	S3200-HCCB501	
			Black 100 m	S3200-HCCB102	
			Black 500 m	S3200-HCCB502	
			Black 1,000 m	S3200-HCCB103	
			Orange 10 m	S3200-HCCO101	
			Orange 50 m	S3200-HCCO501	
			Orange 100m	S3200-HCCO102	
			Orange 500 m	S3200-HCCO502	
			Orange 1,000 m	S3200-HCCO103	
Optical Connectors (Crimp-cut) 	CS1W-RPT02	Half lock	S3200-COCF2571	---	
		Full lock	S3200-COCF2071		

● **H-PCF Optical Fiber Cables with Connectors (Black Composite Cables with Two-Optical Lines and Two Power Supply Lines)**

Application	Appearance	Model	Standards
Controller Link, SYSMAC Link		S3200-CN□□□□-20-20	---
		S3200-CN□□□□-20-25	
		S3200-CN□□□□-25-25	

● **Cable Length**

The following cable lengths are available: 2 m, 5 m, 15 m, 20 m. For lengths of 21 m or more, contact your OMRON sales representative.

● **Model Numbers**

Lengths of 2 m, 5 m, 10 m, 15 m, and 20 m

Example: S3200-CN□□□□-20-25

Length of 21 m or more

Example: S3200-CN-20-20

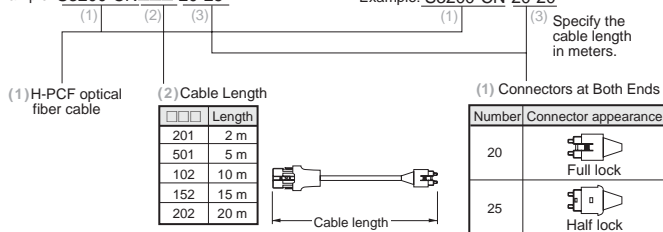

● **Optical Connector Assembly Tool**

Product Name	Applicable Unit	Model	Manufacturer	Standards
Optical Fiber Assembly Tool (See note.)	This tool is used on site for mounting crimp-cut connectors and hard plastic-clad silica optical fiber for optical transmission systems of SYSMAC C-series SYSBUS, SYSMAC LINK, and Controller Link.	CAK-0057	Sumitomo Electric Industries, Ltd.	---

Note: There is a risk of quality problems when using cables assembled by typical users, so we recommend purchasing cables with preattached connectors or having a qualified technician assemble the cables. Optical connectors for H-PCF Optical Cables with Connectors are adhesive polished.

● **GI Optical Cables**

A qualified technician must select, assemble, and install GI Optical Fiber Cable, so always let an optical cable specialist handle the GI cable.

Usable Optical Cables and Optical Connectors

- Optical fiber types: Graded, indexed, multi-mode, all quartz glass, fiber (GI-type AGF cable)
- Optical fiber construction (core diameter/clad diameter): 62.5/125 μm or 50/125 μm
- Optical fiber optical characteristics of optical fiber: Refer to the tables.
- Optical connector: ST connector (IEC-874-10)

● **50/125 μm AGF Cable**

Item	Minimum	Standard	Maximum	Remarks
Numerical Aperture (N.A)	---	0.21	---	---
Transmission loss (dB)	---	---	3.0 Lf	0.5 km ≤ Lf
			3.0 Lf + 0.2	0.2 km ≤ Lf ≤ 0.5 km
			3.0 Lf + 0.4	Lf ≤ 0.2 km
Connection loss (dB)	---	---	1.0	λ = 0.8 μm, one location
Transmission bandwidth (MHz-km)	500	---	---	λ = 0.85 μm (LD)

Lf is fiber length in km, Ta is ambient temperature, and λ: is the peak wavelength of the test light source.

● **62.5/125 μm AGF Cable**

Item	Minimum	Standard	Maximum	Remarks
Numerical Aperture (N.A)	---	0.28	---	---
Transmission loss (dB)	---	---	3.5 Lf	0.5 km ≤ Lf
			3.5 Lf + 0.2	0.2 km ≤ Lf ≤ 0.5 km
			3.5 Lf + 0.4	Lf ≤ 0.2 km
Connection loss (dB)	---	---	1.0	λ = 0.8 μm, one location
Transmission bandwidth (MHz-km)	200	---	---	λ = 0.85 μm (LD)

Lf is fiber length in km, Ta is ambient temperature, and λ is the peak wavelength of the test light source.

■ FL-net Unit

Unit classification	Product name	Specifications			No. of unit numbers allocated	Current consumption (A)		Model	Standards
		Communications interface	Communications functions	Max. Units mountable per CPU Units		5 V	24 V		
CJ1 CPU Bus Units	 FL-net Unit	100Base-TX	With FL-net Ver. 2.0 specifications (OPCN-2) Data links and message service	4	1	0.37	---	CJ1W-FLN22	UC1, CE

■ DeviceNet Unit

Unit classification	Product name	Specifications	Communications type	No. of unit numbers allocated	Current consumption (A)		Model	Standards
					5 V	24 V		
CJ1 CPU Bus Units	 DeviceNet Unit	Functions as master and/or slave; allows control of 32,000 points max. per master.	<ul style="list-style-type: none"> Remote I/O communications master (fixed or user-set allocations) Remote I/O communications slave (fixed or user-set allocations) Message communications 	1	0.29	---	CJ1W-DRM21	UC1, N, L, CE

■ CompoNet Master Unit

Unit classification	Product name	Specifications		No. of unit numbers allocated	Current consumption (A)		Model	Standards
		Communications functions	No. of I/O points per Master Unit		5 V	24 V		
CJ1 Special I/O Units	 CompoNet Master Unit	<ul style="list-style-type: none"> Remote I/O communications Message communications 	Word Slaves: 2,048 max. (1,024 inputs and 1,024 outputs) Bit Slaves: 512 max. (256 inputs and 256 outputs)	1, 2, 4, or 8	0.4	---	CJ1W-CRM21	U, U1, N, L, CE,

■ CompoBus/S Master Unit



Unit classification	Product name	Specifications			No. of unit numbers allocated	Current consumption (A)		Model	Standards
		Communications functions	No. of I/O points	Max. Units mountable per CPU Unit		5 V	24 V		
CJ1 Special I/O Units	 CompoBus/S Master Unit	Remote I/O communications	256 max. (128 inputs and 128 outputs) 128 max. (64 inputs and 64 outputs)	40	1 or 2 (variable)	0.15	---	CJ1W-SRM21	UC1, N, L, CE,

■ ID Sensor Units

Unit classification	Product name	Specifications			No. of unit numbers allocated	Current consumption (A)		Model	Standards
		Connected ID Systems	No. of connected R/W heads	External power supply		5 V	24 V		
CJ1 CPU Bus Units	 ID Sensor Units	V680 Series RFID System	1	Not required.	1	0.26	0.13 (See note.)	CJ1W-V680C11	UC, CE
			2		2	0.32	0.26	CJ1W-V680C12	
		V600 Series RFID System	1	Not required.	1	0.26	0.12	CJ1W-V600C11	UC, CE
			2		2	0.32	0.24	CJ1W-V600C12	

Note: To use a V680-H01 Antenna, refer to the *V680 Series RFID System Catalog* (Cat. No. Q151).

■ SYSMAC SPU (High-speed Data Storage Unit)

Unit classification	Product name	Specifications		No. of unit numbers allocated	Current consumption (A)		Model	Standards	
		PC Card slot	Ethernet (LAN) port		5 V	24 V			
CJ1 CPU Bus Units	 SYSMAC SPU (High-speed Data Storage Unit)	CF Card Type I/II × 1 slot Use an OMRON HMC-EF□□□ Memory Card.	1 port (10/100Base-TX)	1	0.56	---	CJ1W-SPU01-V2	UC1, CE	
	SPU-Console (See note.)	Functions: Unit settings, sampling settings, etc., for High-speed Data Collection Units (required for making settings for this Unit) OS: Windows 2000, XP, Vista						WS02-SPTC1-V2	---
	SYSMAC SPU Data Management Middleware	Function: Data files collected by SYSMAC SPU Data Management Middleware are automatically acquired at the personal computer, and can be registered in a database. OS: Windows 2000, XP, Vista			1 license	WS02-EDMC1-V2			
					5 licenses	WS02-EDMC1-V2L05			
 Memory Cards	Flash memory, 128 MB			Note: Memory Card is required for data collection.	HMC-EF183				
	Flash memory, 256 MB				HMC-EF283				
	Flash memory, 512 MB				HMC-EF583				

Note: SPU-Console versions lower than version 2.0 cannot connect to SYSMAC SPU Units with unit versions of 2.0 or later.

Read and Understand this Catalog

Please read and understand this catalog before purchasing the product. Please consult your OMRON representative if you have any questions or comments.

Warranty and Limitations of Liability

WARRANTY

OMRON's exclusive warranty is that the products are free from defects in materials and workmanship for a period of one year (or other period if specified) from date of sale by OMRON.

OMRON MAKES NO WARRANTY OR REPRESENTATION, EXPRESS OR IMPLIED, REGARDING NON-INFRINGEMENT, MERCHANTABILITY, OR FITNESS FOR PARTICULAR PURPOSE OF THE PRODUCTS. ANY BUYER OR USER ACKNOWLEDGES THAT THE BUYER OR USER ALONE HAS DETERMINED THAT THE PRODUCTS WILL SUITABLY MEET THE REQUIREMENTS OF THEIR INTENDED USE. OMRON DISCLAIMS ALL OTHER WARRANTIES, EXPRESS OR IMPLIED.

LIMITATIONS OF LIABILITY

OMRON SHALL NOT BE RESPONSIBLE FOR SPECIAL, INDIRECT, OR CONSEQUENTIAL DAMAGES, LOSS OF PROFITS OR COMMERCIAL LOSS IN ANY WAY CONNECTED WITH THE PRODUCTS, WHETHER SUCH CLAIM IS BASED ON CONTRACT, WARRANTY, NEGLIGENCE, OR STRICT LIABILITY.

In no event shall the responsibility of OMRON for any act exceed the individual price of the product on which liability is asserted.

IN NO EVENT SHALL OMRON BE RESPONSIBLE FOR WARRANTY, REPAIR, OR OTHER CLAIMS REGARDING THE PRODUCTS UNLESS OMRON'S ANALYSIS CONFIRMS THAT THE PRODUCTS WERE PROPERLY HANDLED, STORED, INSTALLED, AND MAINTAINED AND NOT SUBJECT TO CONTAMINATION, ABUSE, MISUSE, OR INAPPROPRIATE MODIFICATION OR REPAIR.

Application Considerations

SUITABILITY FOR USE

OMRON shall not be responsible for conformity with any standards, codes, or regulations that apply to the combination of the product in the customer's application or use of the product.

At the customer's request, OMRON will provide applicable third party certification documents identifying ratings and limitations of use that apply to the products. This information by itself is not sufficient for a complete determination of the suitability of the products in combination with the end product, machine, system, or other application or use.

The following are some examples of applications for which particular attention must be given. This is not intended to be an exhaustive list of all possible uses of the products, nor is it intended to imply that the uses listed may be suitable for the products:

- Outdoor use, uses involving potential chemical contamination or electrical interference, or conditions or uses not described in this document.
- Nuclear energy control systems, combustion systems, railroad systems, aviation systems, medical equipment, amusement machines, vehicles, safety equipment, and installations subject to separate industry or government regulations.
- Systems, machines, and equipment that could present a risk to life or property.
Please know and observe all prohibitions of use applicable to the products.

NEVER USE THE PRODUCT FOR AN APPLICATION INVOLVING SERIOUS RISK TO LIFE OR PROPERTY WITHOUT ENSURING THAT THE SYSTEM AS A WHOLE HAS BEEN DESIGNED TO ADDRESS THE RISKS, AND THAT THE OMRON PRODUCT IS PROPERLY RATED AND INSTALLED FOR THE INTENDED USE WITHIN THE OVERALL EQUIPMENT OR SYSTEM.

PROGRAMMABLE PRODUCTS

OMRON shall not be responsible for the user's programming of a programmable product, or any consequence thereof.

Disclaimers

CHANGE IN SPECIFICATIONS

Product specifications and accessories may be changed at any time based on improvements and other reasons. Consult with your OMRON representative at any time to confirm actual specifications of purchased product.

DIMENSIONS AND WEIGHTS

Dimensions and weights are nominal and are not to be used for manufacturing purposes, even when tolerances are shown.

PERFORMANCE DATA

Performance data given in this catalog is provided as a guide for the user in determining suitability and does not constitute a warranty. It may represent the result of OMRON's test conditions, and the users must correlate it to actual application requirements. Actual performance is subject to the OMRON Warranty and Limitations of Liability.

OMRON Corporation Industrial Automation Company

Tokyo, JAPAN

Contact: www.ia.omron.com

Regional Headquarters

OMRON EUROPE B.V.

Wegalaan 67-69-2132 JD Hoofddorp
The Netherlands
Tel: (31)2356-81-300/Fax: (31)2356-81-388

OMRON ELECTRONICS LLC

One Commerce Drive Schaumburg,
IL 60173-5302 U.S.A.
Tel: (1) 847-843-7900/Fax: (1) 847-843-7787

OMRON ASIA PACIFIC PTE. LTD.

No. 438A Alexandra Road # 05-05/08 (Lobby 2),
Alexandra Technopark,
Singapore 119967
Tel: (65) 6835-3011/Fax: (65) 6835-2711

OMRON (CHINA) CO., LTD.

Room 2211, Bank of China Tower,
200 Yin Cheng Zhong Road,
PuDong New Area, Shanghai, 200120, China
Tel: (86) 21-5037-2222/Fax: (86) 21-5037-2200

Authorized Distributor:

© OMRON Corporation 2001-2012 All Rights Reserved.
In the interest of product improvement,
specifications are subject to change without notice.

CSM_2_1_0912
Cat. No. **P052-E1-12**

Printed in Japan
0412 (0901)