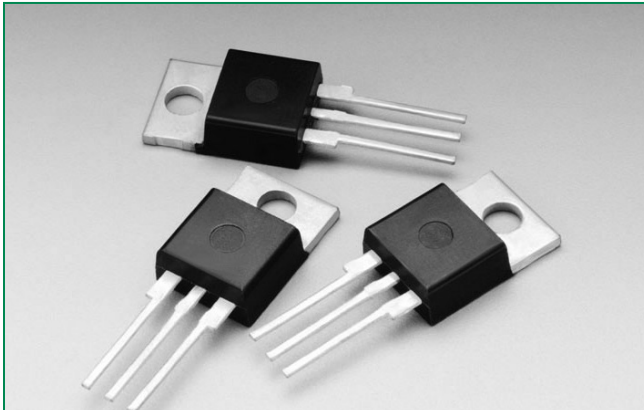


QJxx30LH4 series



**Description**

This 30A high temperature Alternistor TRIAC series enables easier thermal management and higher surge handling capability in AC power control applications such as heater control, motor speed control, lighting controls, and static switching relays.

Alternistor TRIAC operates in quadrants I, II, & III and offers high performance in applications requiring high commutation capability.

**Agency Recognitions**

Agency	Agency File Number
	E71639

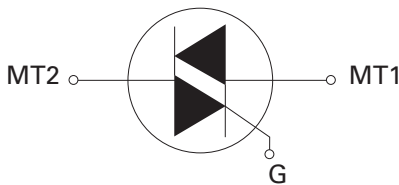
**Main Features**

Symbol	Value	Unit
$I_{T(RMS)}$	30	A
$V_{DRM}/V_{RRM}$	600 or 800	V
$I_{GT(Q1)}$	35	mA

**Features & Benefits**

- High  $T_j$  of 150°C
- Voltage capability up to 800V
- Surge capability of 350A at 60Hz half cycle
- Mechanically and thermally robust TO-220 clip-attach assembly
- Electrically isolated for 2500Vrms
- UL Recognized to UL 1557 as an Electrically Isolated Semiconductor Device.
- Halogen-free and RoHS-compliant

**Schematic Symbol**



**Applications**

TRIAC is an excellent AC switch in applications such as heating, lighting, and motor speed controls.

Typical applications are

- Heater control such as coffee brewer, tankless water heater and infrared heater
- AC solid-state relays
- Light dimmers including incandescent and LED lighting
- Motor speed control in kitchen appliances, power tools, home/brow/white goods and light industrial applications as compressor motor control

Alternistor TRIAC is used with high inductive loads requiring the high commutation capability. Internally isolated packages offer better heat sinking with higher isolation voltage.

### Absolute Maximum Ratings — Alternistor Triac (3 Quadrants)

Symbol	Parameter	Value	Unit
$V_{DSM}/V_{RSM}$	Peak non-repetitive blocking voltage	pulse width = 100 $\mu$ s $V_{DRM}+200V$	V
$I_{T(RMS)}$	RMS on-state current (full sine wave)	$T_C = 105^\circ C$	30 A
$I_{TSM}$	Non repetitive surge peak on-state current (Single half cycle, $T_J$ initial = 25°C)	f = 50Hz t = 20 ms f = 60Hz t = 16.7 ms	290 350 A
$I^2t$	$I^2t$ Value for fusing	$t_p = 8.3$ ms	508 A <sup>2</sup> s
di/dt	Critical rate of rise of on-state current	f = 60Hz $T_J = 150^\circ C$	100 A/ $\mu$ s
$I_{GTM}$	Peak gate trigger current	$t_p \leq 20\mu s$ ; $I_{GT} \leq I_{GTM}$ $T_J = 150^\circ C$	4.0 A
$P_{G(AV)}$	Average gate power dissipation	$T_J = 150^\circ C$	1.0 W
$T_{stg}$	Storage temperature range		-40 to 150 °C
$T_J$	Operating junction temperature range		-40 to 150 °C

y = sensitivity

### Electrical Characteristics ( $T_J = 25^\circ C$ , unless otherwise specified) — Alternistor Triac (3 Quadrants)

Symbol	Test Conditions	Quadrant	Value	Unit
$I_{GT}$	$V_D = 12V$ $R_L = 60\Omega$	I – II – III	MAX.	35 mA
$V_{GT}$		I – II – III	MAX.	1.0 V
$V_{GD}$	$V_D = V_{DRM}$ $R_L = 3.3k\Omega$ $T_J = 150^\circ C$	I – II – III	MIN.	0.2 V
$I_H$	$I_T = 100mA$		MAX.	60 mA
dv/dt	$V_D = 2/3 V_{DRM}$ Gate Open $T_J = 150^\circ C$		MIN.	1500 V/ $\mu$ s
(dv/dt)c	(di/dt)c = 18.9 A/ms $T_J = 150^\circ C$		MIN.	20 V/ $\mu$ s
$t_{gt}$	$I_G = 2 \times I_{GT}$ PW = 15 $\mu$ s $I_T = 42.4$ A(pk)		TYP.	3 $\mu$ s

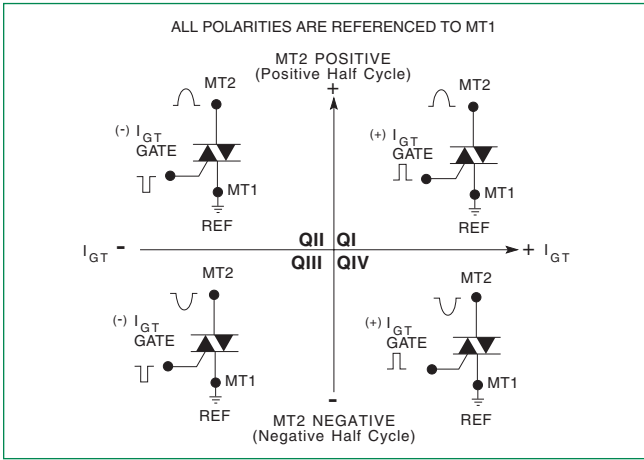
### Static Characteristics

Symbol	Test Conditions	Value	Unit	
$V_{TM}$	$I_T = 42.4A$ $t_p = 380\mu s$	MAX	1.5 V	
$I_{DRM}/I_{RRM}$	@ $V_{DRM}/V_{RRM}$	$T_J = 25^\circ C$ $T_J = 150^\circ C$	MAX	5 3 $\mu$ A mA

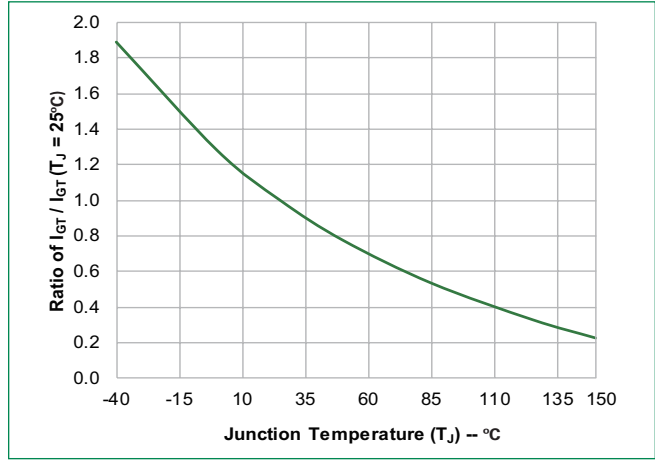
### Thermal Resistances

Symbol	Parameter	Value	Unit
$R_{\theta(JC)}$	Junction to case (AC)	3.2	°C/W

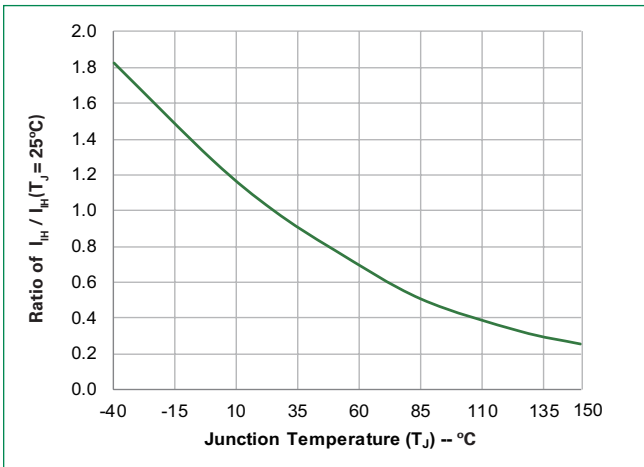
**Figure 1: Definition of Quadrants**



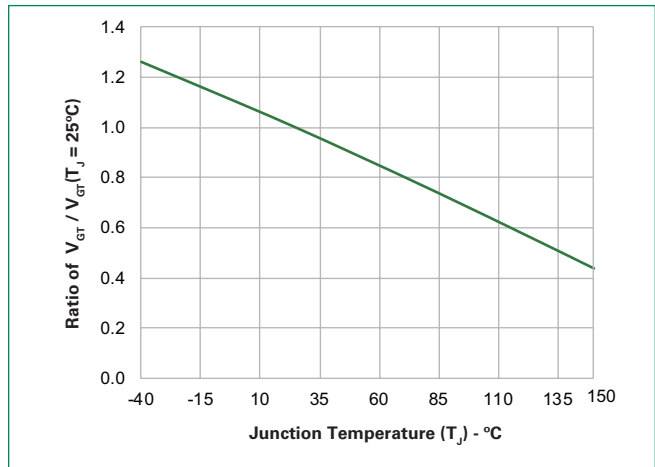
**Figure 2: Normalized DC Gate Trigger Current for All Quadrants vs. Junction Temperature**



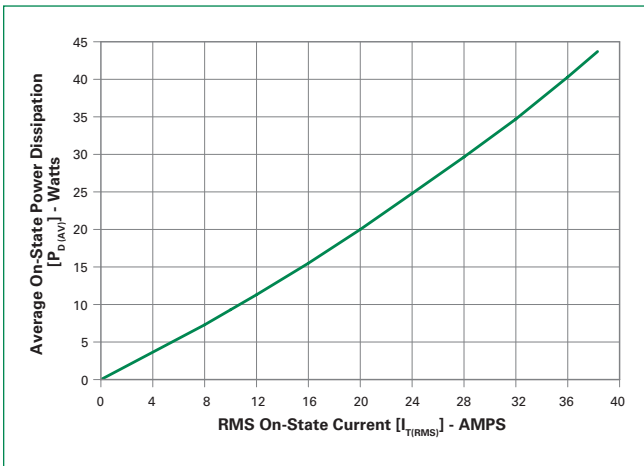
**Figure 3: Normalized DC Holding Current vs. Junction Temperature**



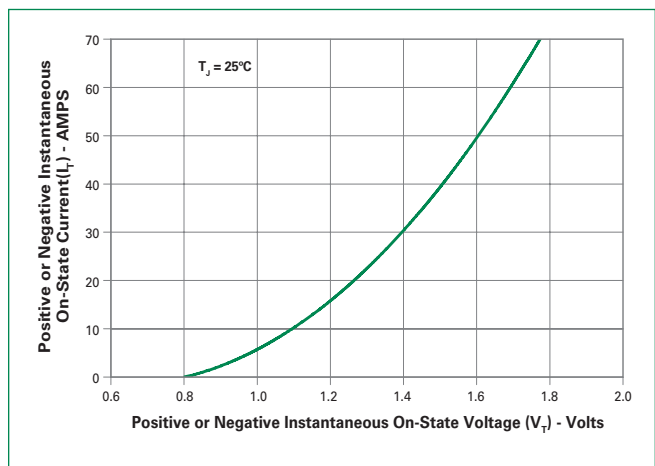
**Figure 4: Normalized DC Gate Trigger Voltage for All Quadrants vs. Junction Temperature**



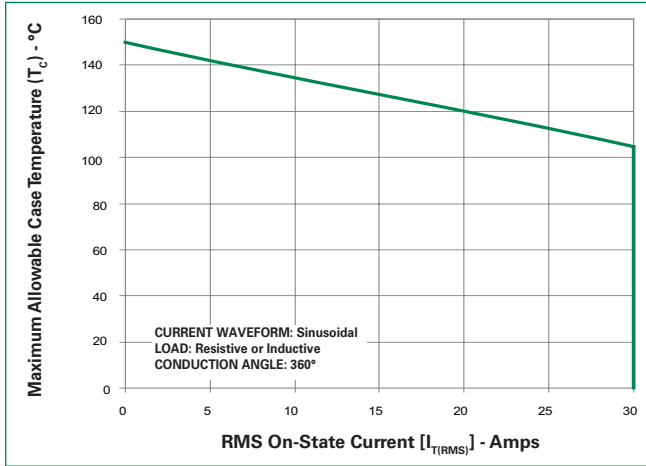
**Figure 5: Power Dissipation (Typical) vs. RMS On-State Current**



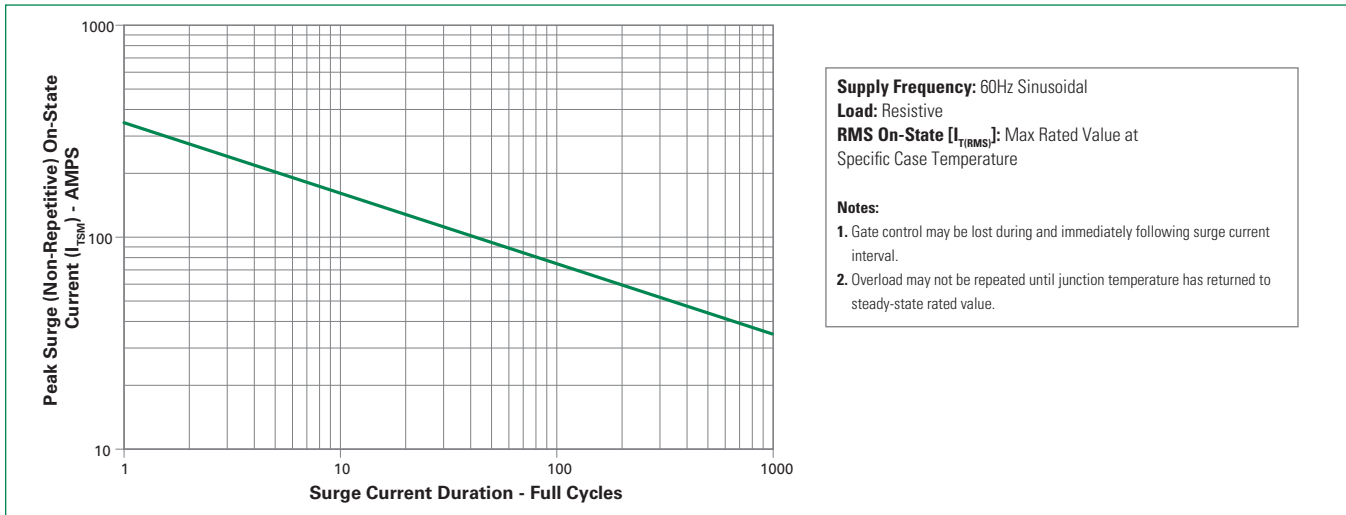
**Figure 6: On-State Current vs. On-State Voltage (Typical)**



**Figure 7: Maximum Allowable Case Temperature vs. RMS On-State Current**

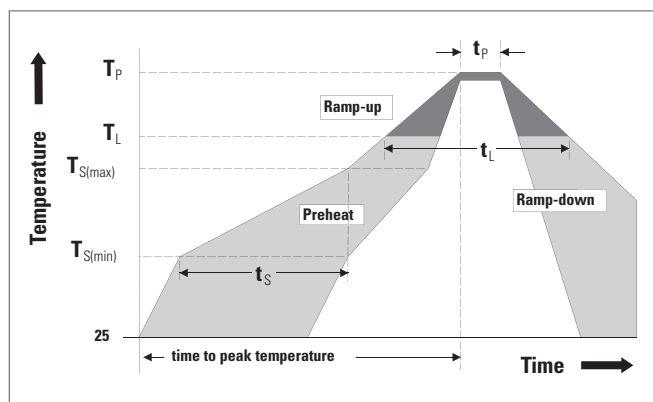


**Figure 8: Surge Peak On-State Current vs. Number of Cycles**



**Soldering Parameters**

<b>Reflow Condition</b>		Pb – Free assembly
<b>Pre Heat</b>	- Temperature Min (T <sub>s(min)</sub> )	150°C
	- Temperature Max (T <sub>s(max)</sub> )	200°C
	- Time (min to max) (t <sub>s</sub> )	60 – 180 secs
<b>Average ramp up rate (Liquidus Temp) (T<sub>L</sub>) to peak</b>		5°C/second max
<b>T<sub>S(max)</sub> to T<sub>L</sub> - Ramp-up Rate</b>		5°C/second max
<b>Reflow</b>	- Temperature (T <sub>L</sub> ) (Liquidus)	217°C
	- Time (t <sub>L</sub> )	60 – 150 seconds
<b>Peak Temperature (T<sub>p</sub>)</b>		260 <sup>+0/-5</sup> °C
<b>Time within 5°C of actual peak Temperature (t<sub>p</sub>)</b>		20 – 40 seconds
<b>Ramp-down Rate</b>		5°C/second max
<b>Time 25°C to peak Temperature (T<sub>p</sub>)</b>		8 minutes Max.
<b>Do not exceed</b>		280°C



### Physical Specifications

<b>Terminal Finish</b>	100% Matte Tin-plated
<b>Body Material</b>	UL Recognized compound meeting flammability rating V-0
<b>Terminal Material</b>	Copper Alloy

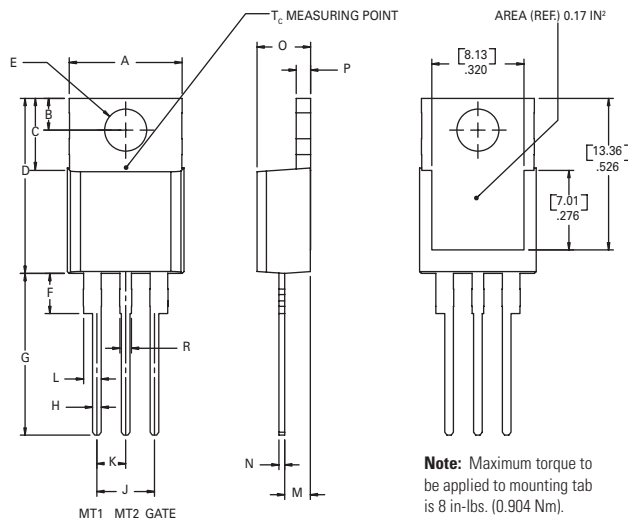
### Design Considerations

Careful selection of the correct component for the application's operating parameters and environment will go a long way toward extending the operating life of the Thyristor. Good design practice should limit the maximum continuous current through the main terminals to 75% of the component rating. Other ways to ensure long life for a power discrete semiconductor are proper heat sinking and selection of voltage ratings for worst case conditions. Overheating, overvoltage (including dv/dt), and surge currents are the main killers of semiconductors. Correct mounting, soldering, and forming of the leads also help protect against component damage.

### Environmental Specifications

Test	Specifications and Conditions
<b>AC Blocking</b>	MIL-STD-750, M-1040, Cond A Applied Peak AC voltage @ 150°C for 1008 hours
<b>Temperature Cycling</b>	MIL-STD-750, M-1051, 100 cycles; -40°C to +150°C; 15-min dwell time
<b>Temperature/Humidity</b>	EIA / JEDEC, JESD22-A101 1008 hours; 320V - DC: 85°C; 85% rel humidity
<b>High Temp Storage</b>	MIL-STD-750, M-1031, 1008 hours; 150°C
<b>Low-Temp Storage</b>	1008 hours; -40°C
<b>Resistance to Solder Heat</b>	MIL-STD-750 Method 2031
<b>Solderability</b>	ANSI/J-STD-002, category 3, Test A
<b>Lead Bend</b>	MIL-STD-750, M-2036 Cond E
<b>Moisture Sensitivity Level</b>	Level 1, JEDEC-J-STD-020

### Dimensions – TO-220AB (L-Package) – Isolated Mounting Tab



Dimension	Inches		Millimeters	
	Min	Max	Min	Max
<b>A</b>	0.380	0.420	9.65	10.67
<b>B</b>	0.105	0.115	2.67	2.92
<b>C</b>	0.230	0.250	5.84	6.35
<b>D</b>	0.590	0.620	14.99	15.75
<b>E</b>	0.142	0.147	3.61	3.73
<b>F</b>	0.110	0.130	2.79	3.30
<b>G</b>	0.540	0.575	13.72	14.60
<b>H</b>	0.025	0.035	0.64	0.89
<b>J</b>	0.195	0.205	4.95	5.21
<b>K</b>	0.095	0.105	2.41	2.67
<b>L</b>	0.060	0.075	1.52	1.91
<b>M</b>	0.085	0.095	2.16	2.41
<b>N</b>	0.018	0.024	0.46	0.61
<b>O</b>	0.178	0.188	4.52	4.78
<b>P</b>	0.045	0.060	1.14	1.52
<b>R</b>	0.038	0.048	0.97	1.22

### Product Selector

Part Number	Voltage				Gate Sensitivity		I <sub>T(RMS)</sub>	Type	Package
	400V	600V	800V	1000V	I-II-III	IV			
QJxx30LH4	-	x	x	-	35mA		30A	Alternistor Triac	TO-220L

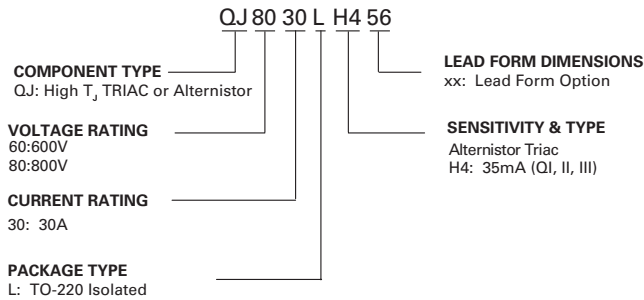
Note: xx = Voltage/10

### Packing Options

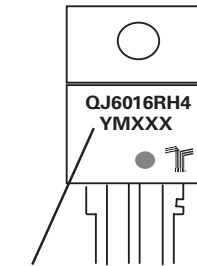
Part Number	Marking	Weight	Packing Mode	Base Quantity
QJxx30LH4	QJxx30LH4	2.2	Tube	1000 (50 per tube)

y = Sensitivity

### Part Numbering System



### Part Marking System



Date Code Marking  
Y: Year Code  
M: Month Code  
XXX: Lot Trace Code