

FAN1950 — 1.5A Low-Voltage, Low-Dropout Regulator

Features

- 1.5A Minimum Guaranteed Output Current
- 500mV Maximum Dropout at 1.5A
 - Ideal for 2.5V to 1.8V or 1.65V Conversion
 - Ideal for 3.0V to 2.5V Conversion
- Current Limiting and Thermal Shutdown
- Fast Transient Response
- Low Ground Current

Description

The FAN1950 is a 1.5A low-dropout linear regulator that provides a low-voltage, high-current output with a minimum of external components. This device uses a PNP output pass element, achieving a maximum 500mV dropout at 1.5A load current. Over-current limit and thermal shutdown features to ensure full protection.

Applications

- General-purpose Conversion for Low-voltage CPUs, DSPs, and FPGAs
- SMPS Post Regulators
- Cable / Satellite Set-top Boxes
- PCI Graphics Adapter Cards

Ordering Information

Part Number	Output Voltage	Package	Packing Method
FAN1950D25X	2.5V	3-Lead TO-252 DPAK	Tape and Reel

 All packages are lead free per JEDEC: J-STD-020B standard.

Typical Application

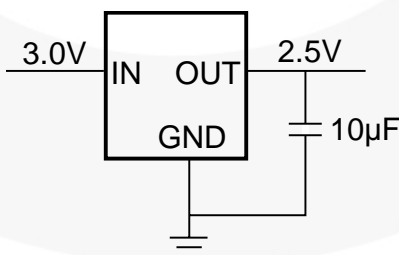

Figure 1. Typical Application

Pin Configuration

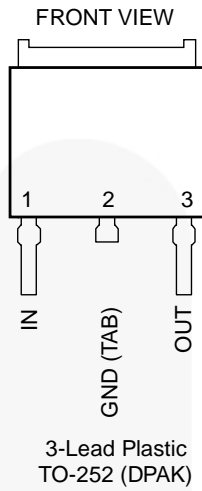

Figure 2. Pin Assignment

Pin Definitions

Pin #	Name	Description
1	IN	Input Supply Voltage
2	GND	Ground. This pin and TAB are ground.
3	OUT	Output Voltage

Absolute Maximum Ratings

Stresses exceeding the absolute maximum ratings may damage the device. The device may not function or be operable above the recommended operating conditions and stressing the parts to these levels is not recommended. In addition, extended exposure to stresses above the recommended operating conditions may affect device reliability. The absolute maximum ratings are stress ratings only.

Symbol	Parameter	Min.	Max.	Unit
V _{IN}	Supply Voltage	-0.2	15.0	V
V _{EN}	Enable Voltage ⁽¹⁾	-0.2	15.0	V
FLAG	Flag Voltage ^(1,2)	-0.2	15.0	V
T _J	Junction Temperature	-55	+150	°C
T _{STG}	Storage Temperature	-65	+150	°C
T _L	Lead Soldering Temperature, 10 Seconds		+300	°C
P _D	Power Dissipation		Internally Limited	W

Notes:

- Internally connected through bond wires.
- Flag output cannot be pulled to a voltage higher than V_{IN}.

Recommended Operating Conditions

The Recommended Operating Conditions table defines the conditions for actual device operation. Recommended operating conditions are specified to ensure optimal performance to the datasheet specifications. Fairchild does not recommend exceeding them or designing to Absolute Maximum Ratings.

Symbol	Parameter	Min.	Typ.	Max.	Unit
V _{CC}	Supply Voltage	2.25		14.00	V
Θ _{JA}	Thermal Resistance		3		°C/W
T _J	Junction Operating Temperature	-40		+125	°C

Electrical Characteristics

$V_{IN}=V_{OUT}+1V$, $V_{EN}=2.5V$, $T_J=+25^{\circ}C$, unless other wise specified. The • denotes specifications that apply over the full operating temperature range.

Symbol	Parameter	Conditions	Min.	Typ.	Max.	Units
V_{OUT}	Output Voltage Tolerance	$10mA \leq I_{OUT} \leq 1.0A$	•	-2	2	%
		$5mA \leq I_{OUT} \leq 1.0A, V_{OUT}+1V \leq V_{IN} \leq 8V$	•	-2.5	2.5	
R_{LINE}	Line Regulation ^(3,4)	$I_{OUT}=10mA, V_{OUT}+1V \leq V_{IN} \leq 14V$.06	.50	%
R_{LOAD}	Load Regulation ^(3,4)	$V_{IN}=V_{OUT} + 1V, 10mA \leq I_{OUT} \leq 1.5A$		0.2	1.0	%
V_{DO}	Drop-out Voltage ⁽⁵⁾	$I_{OUT}=1.5A, \Delta V_{OUT}=-1\%$	•	350	500	mV
I_{GND}	Ground Current	$I_{OUT}=750mA$	•	10	20	mA
		$I_{OUT}=1.5A$		20	20	
I_{LOAD}	Minimum Load Current	$V_{OUT}+1V \leq V_{IN} \leq 8V$	•	5	10	mA
I_{LIM}	Current Limit	$V_{OUT}=0V, V_{IN}=V_{OUT}+1V$	•	2.5		A
T_{TSD}	Thermal Shutdown Temperature			+150		$^{\circ}C$
T_{HYS}	Thermal shutdown Hysteresis			+10		$^{\circ}C$
I_{SDO}	Shutdown Output Current	$V_{EN} \leq 0.8V, V_{IN} \leq 8V, V_{OUT}=0V$	•		20	μA

Notes:

- See thermal regulation specifications for changes in output voltage due to heating effects. Load and line regulation are measured at a constant junction temperature by low duty cycle pulse testing.
- Line and load regulation are guaranteed up to the maximum power dissipation. Power dissipation is determined by input/output differential and the output current. Guaranteed maximum output power is not available over the full input/output voltage range.
- Dropout voltage= $V_{IN}-V_{OUT}$ when V_{OUT} decreases to 98% of its nominal output voltage with $V_{IN}=V_{OUT}+1V$. For output voltages below 2.25V, dropout voltage is the input-to-output voltage differential with the minimum input voltage being 2.25V. Minimum input operating voltage is 2.25V.

Typical Performance Characteristics

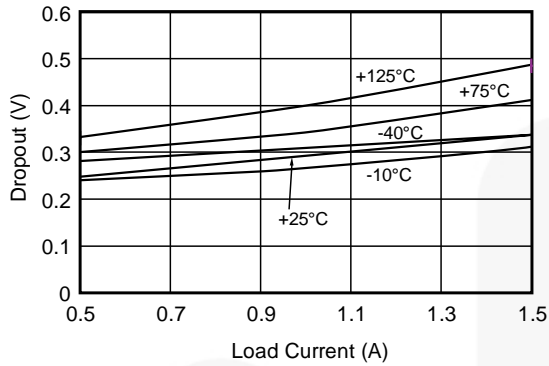

Figure 3. Dropout Voltage vs. Output Current

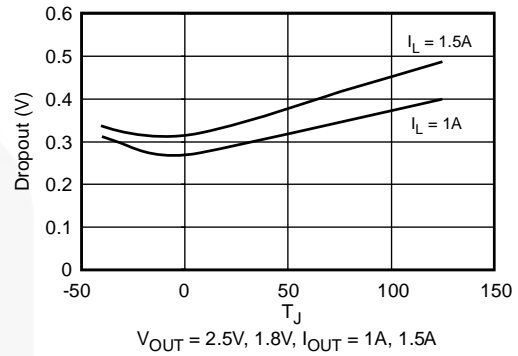

Figure 4. Dropout Voltage vs. Temperature

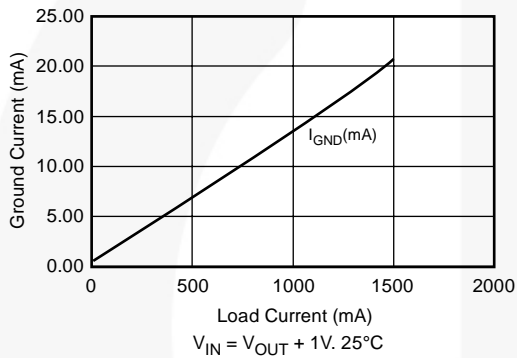

Figure 5. Ground Current vs. Load Current

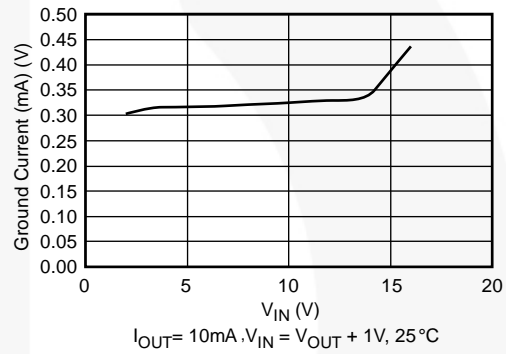

Figure 6. Ground Current vs. Supply Voltage

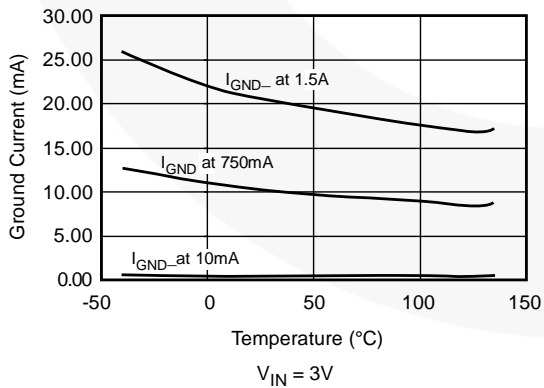

Figure 7. Ground Current vs. Temperature

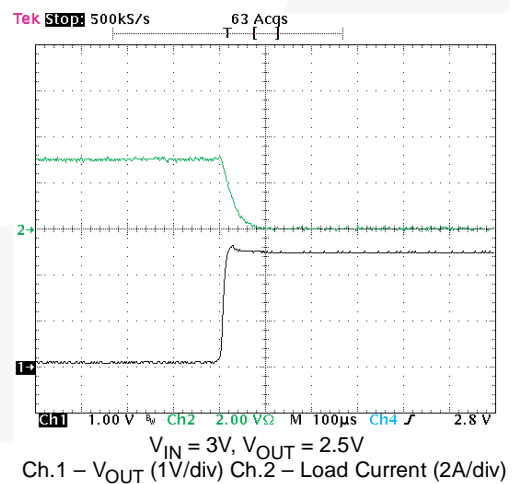
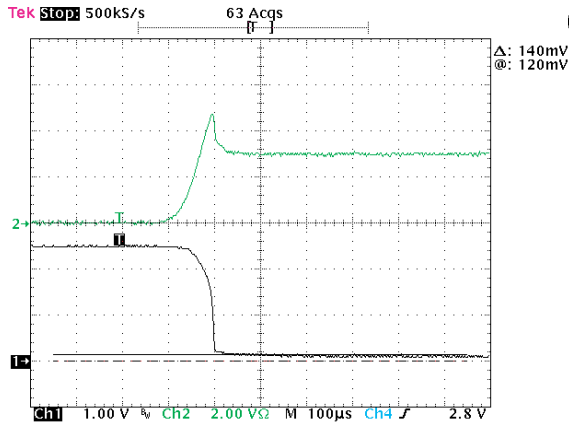

Figure 8. Short-Circuit Recovery Response

Typical Performance Characteristics (Continued)



$V_{IN} = 3V, V_{OUT} = 2.5V$
Ch.1 - V_{OUT} (1V/div) Ch.2 - Load Current (2A/div)

Figure 9. Short-Circuit Transient Response

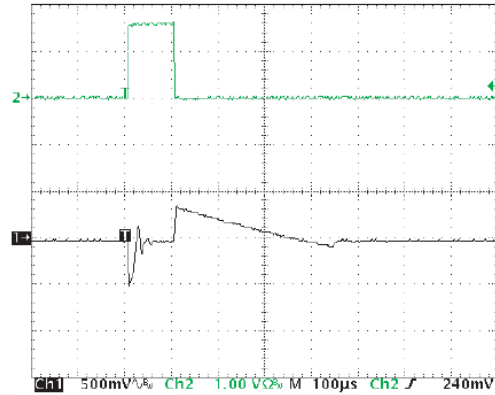

$V_{IN}=2.5V, V_{OUT}=1.8V, C_{IN}=10\mu F$ Ceramic $C_{OUT}=10\mu F$ Ceramic
Ch1- $V_{OUT}(AC, 0.5V/div)$ Ch2- Load Current (1A/div)

Figure 10. Load Transient Response

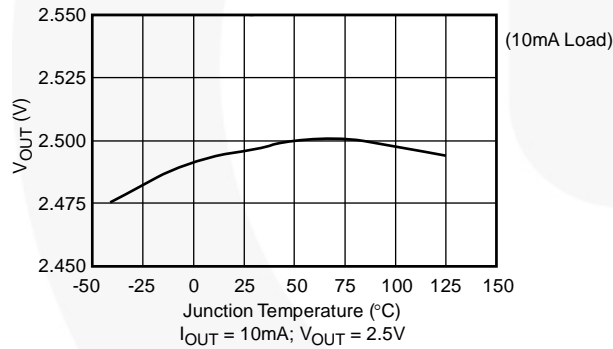
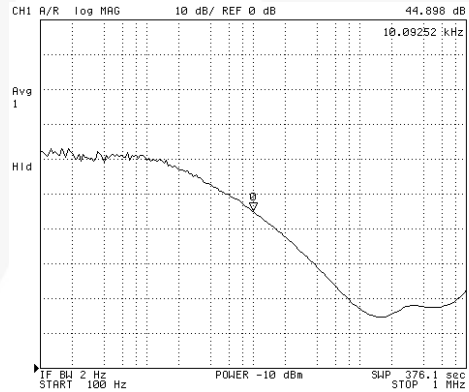

Figure 11. V_{OUT} vs. Temperature



$V_{IN} = 5V, V_{OUT} = 2.5V$ Load = 1A
 $C_{IN} = C_{OUT} = 10\mu F/ 6.3V$ Tantalum
PSRR - 10dB/div

Figure 12. Ripple Rejection

Input and Output Capacitor Requirements

A 4.7 μ F or greater input capacitor (ceramic or tantalum), installed closely between the V_{IN} and GND leads of the part; is required for stability, better transient response, noise, and ripple rejection. A higher value of electrolytic input capacitor can be used if the bulk capacitor of the power supply is located more than 2-4 inches from the device or a large and fast rise-time load is a requirement.

Most LDO regulators require an output capacitor with a recommended value of 10 μ F. The larger capacitor

improves the transient response, ripple rejection, and output noise. The low-ESR tantalum capacitors are the best for this application because they provide stable work and good transient response over the temperature range. Using a ceramic capacitor as the output capacitor can provoke instability (oscillation in the output voltage). Aluminum electrolytic capacitors also can be used if the ESR is below 3 Ω .

Physical Dimensions

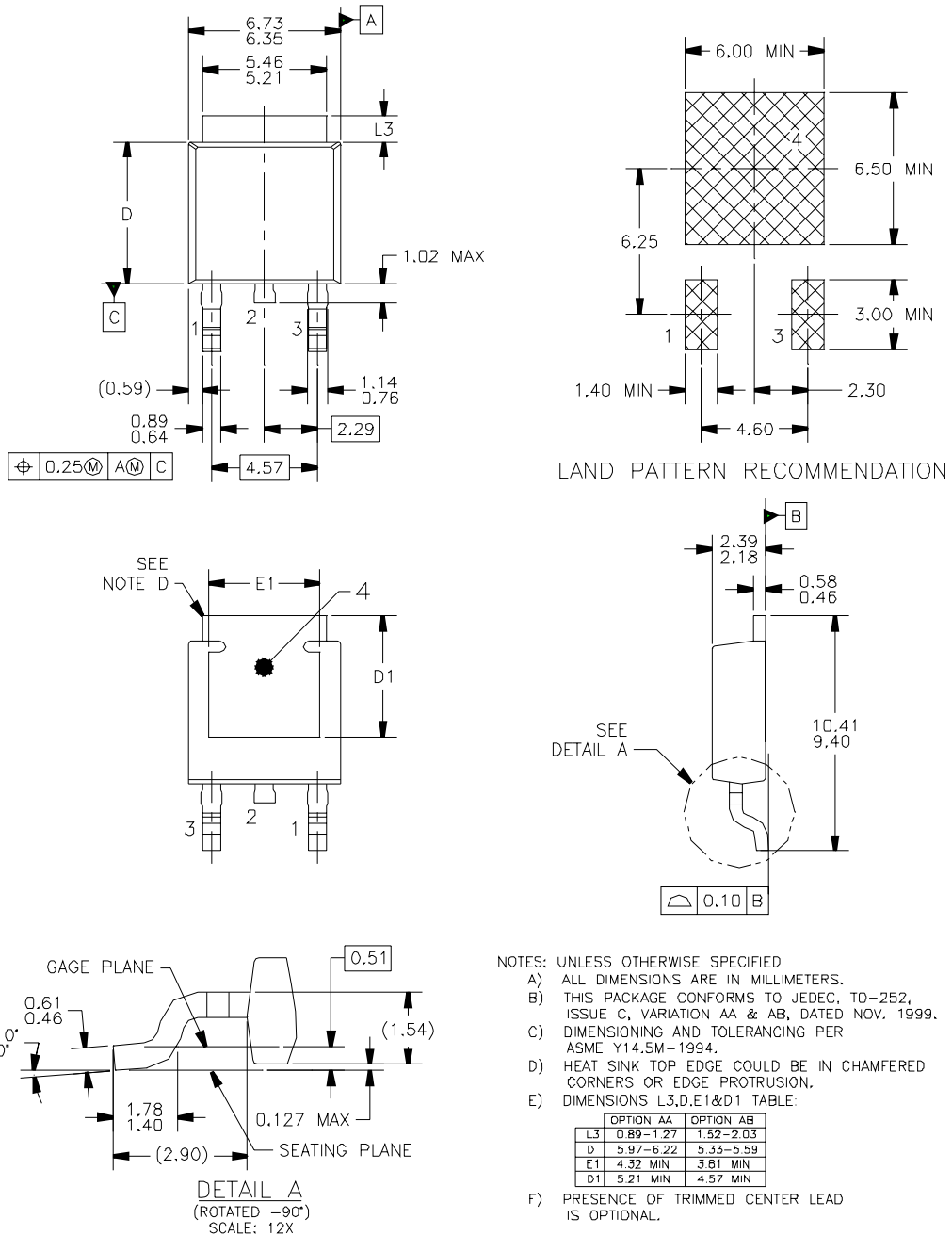

Figure 13. 3-Lead TO-252 DPAK Package

Package drawings are provided as a service to customers considering Fairchild components. Drawings may change in any manner without notice. Please note the revision and/or date on the drawing and contact a Fairchild Semiconductor representative to verify or obtain the most recent revision. Package specifications do not expand the terms of Fairchild's worldwide terms and conditions, specifically the warranty therein, which covers Fairchild products.

Always visit Fairchild Semiconductor's online packaging area for the most recent package drawings:
<http://www.fairchildsemi.com/packaging/>



TRADEMARKS

The following includes registered and unregistered trademarks and service marks, owned by Fairchild Semiconductor and/or its global subsidiaries, and is not intended to be an exhaustive list of all such trademarks.

- | | | | |
|---|---|---|---|
| ACEx [®] | FPST [™] | PDP SPM [™] | The Power Franchise [®] |
| Build it Now [™] | F-PFS [™] | Power-SPM [™] |  |
| CorePLUS [™] | FRFET [®] | PowerTrench [®] | TinyBoost [™] |
| CorePOWER [™] | Global Power Resource SM | Programmable Active Droop [™] | TinyBuck [™] |
| CROSSVOLT [™] | Green FPST [™] | QFET [®] | TinyLogic [®] |
| CTL [™] | Green FPST [™] e-Series [™] | QS [™] | TINYOPTO [™] |
| Current Transfer Logic [™] | GTQ [™] | Quiet Series [™] | TinyPower [™] |
| EcoSPARK [®] | IntelliMAX [™] | RapidConfigure [™] | TinyPWM [™] |
| EfficientMax [™] | ISOPLANAR [™] | Saving our world, 1mW at a time [™] | TinyWire [™] |
| EZSWITCH [™] * | MegaBuck [™] | SmartMax [™] | μSerDes [™] |
|  | MICROCOUPLER [™] | SMART START [™] |  |
|  | MicroFET [™] | SPM [®] | UHC [®] |
| Fairchild [®] | MicroPak [™] | STEALTH [™] | Ultra FRFET [™] |
| Fairchild Semiconductor [®] | MillerDrive [™] | SuperFET [™] | UniFET [™] |
| FACT Quiet Series [™] | MotionMax [™] | SuperSOT [™] -3 | VCX [™] |
| FACT [®] | Motion-SPM [™] | SuperSOT [™] -6 | VisualMax [™] |
| FAST [®] | OPTOLOGIC [®] | SuperSOT [™] -8 | |
| FastvCore [™] | OPTOPLANAR [®] | SupreMOS [™] | |
| FlashWriter [®] * | | SyncFET [™] | |
| | |  | |

* EZSWITCH[™] and FlashWriter[®] are trademarks of System General Corporation, used under license by Fairchild Semiconductor.

DISCLAIMER

FAIRCHILD SEMICONDUCTOR RESERVES THE RIGHT TO MAKE CHANGES WITHOUT FURTHER NOTICE TO ANY PRODUCTS HEREIN TO IMPROVE RELIABILITY, FUNCTION, OR DESIGN. FAIRCHILD DOES NOT ASSUME ANY LIABILITY ARISING OUT OF THE APPLICATION OR USE OF ANY PRODUCT OR CIRCUIT DESCRIBED HEREIN; NEITHER DOES IT CONVEY ANY LICENSE UNDER ITS PATENT RIGHTS, NOR THE RIGHTS OF OTHERS. THESE SPECIFICATIONS DO NOT EXPAND THE TERMS OF FAIRCHILD'S WORLDWIDE TERMS AND CONDITIONS, SPECIFICALLY THE WARRANTY THEREIN, WHICH COVERS THESE PRODUCTS.

LIFE SUPPORT POLICY

FAIRCHILD'S PRODUCTS ARE NOT AUTHORIZED FOR USE AS CRITICAL COMPONENTS IN LIFE SUPPORT DEVICES OR SYSTEMS WITHOUT THE EXPRESS WRITTEN APPROVAL OF FAIRCHILD SEMICONDUCTOR CORPORATION.

As used herein:

1. Life support devices or systems are devices or systems which, (a) are intended for surgical implant into the body or (b) support or sustain life, and (c) whose failure to perform when properly used in accordance with instructions for use provided in the labeling, can be reasonably expected to result in a significant injury of the user.
2. A critical component in any component of a life support, device, or system whose failure to perform can be reasonably expected to cause the failure of the life support device or system, or to affect its safety or effectiveness.

PRODUCT STATUS DEFINITIONS

Definition of Terms

Datasheet Identification	Product Status	Definition
Advance Information	Formative / In Design	This datasheet contains the design specifications for product development. Specifications may change in any manner without notice.
Preliminary	First Production	This datasheet contains preliminary data; supplementary data will be published at a later date. Fairchild Semiconductor reserves the right to make changes at any time without notice to improve design.
No Identification Needed	Full Production	This datasheet contains final specifications. Fairchild Semiconductor reserves the right to make changes at any time without notice to improve the design.
Obsolete	Not In Production	This datasheet contains specifications on a product that is discontinued by Fairchild Semiconductor. The datasheet is for reference information only.

Rev. 134